



BU LİSTE ÜRÜNLERİNDE HIZLI TEKLİF ALABİLİRSİNİZ

**Tüm Markaların
Güncel Fiyat Listeleri
web sitemizde
www.eeselektrik.com**





2 0 2 3
FİYAT LİSTESİ
P R I C E L I S T

mutlusan.com.tr

Kalite, İnovasyon, Teknoloji

40.yıl



YENİ ÜRÜN
YAKINDA

SİZ KEYFİNİZE BAKIN,



CIHAZLARINIZI
YÜKSEK GERİLİM
DALGANMALARINDAN

BİZ KORURUZ



ŞOK KORUMALI PRİZ

içindekiler

anahtar priz grubu

Rita Serisi	4
Elitra Plus Serisi	10
Candela Serisi	15
Bron Serisi	21
Nemliyer Serisi	23
Grup priz ve Aksesuarlar	25

kablo kanalları, plastik, tesisat ve aydınlatma grubu

Canalex serisi kapalı tip kablo kanalları	32
Eko serisi kapalı tip kablo kanalları	32
Yapışkan bantlı kapalı tip kablo kanalları	32
Meks serisi kapalı tip kablo kanalları	33
Meks serisi klima kanalı ve aksesuarları	33
Tavan köşe kanalı	33
Süpürgelik kablo kanalları	33
Fugalı süpürgelik	33
Tezgah süpürgeliği	33
Balık sırtı zemin kanalları	33
H.Free flaret kanal ve aksesuarları	34
Kanal aksesuarları	35
Meks plus serisi için priz setleri	37
Kanal için ups ve enerji prizleri 45x45	38
Kablo toplama spirali ve kablo omurga kanalı	41
Sidem serisi renkli kablo kanalları	42
Sidem serisi süpürgelikler ve aksesuarları	42
Comfort w otomat kutuları	46
Comfort zayıf akım kutuları	46
Meksbox w otomat kutuları	47
Kablolu spiraller	48
H. Free spiraller	50
Plastik spiraller	51
Hdpe koruge borular	51
Logar kutuları	51
Eko serisi çelik ve izole kaplı spiraller	52
Meks serisi çelik ve izole kaplı spiraller	52
Metal rakorlar	53
Pvc boy borular ve aksesuarları	54
Fiber klavuz, çelik susta ve plastik sustalar	54

H.Free borular

Kalın boy boru ve dirsek-muflar	56
Polietilen yeraltı boruları	57
Kasa, buat ve kapakları	58
Beton çivili kroşeler	59
Dübeller, vidalar ve kroşeler	59
Kapı otomatığı, trafolar, ziller ve butonları	60
Telefon dağıtım kutu ve aksesuarları	60
Döner, flaşör lambaları ve motorlu sirenler	61
Aspiratör ve sanayi tip vantilatörler	62
Led armatür çeşitleri	65
Armatür çeşitleri	66
Bahçe armatürleri	72
Exit - acil aydınlatma armatürü	73

pano ve endüstriyel grubu

Promex delikli kanallar	76
Delikli kablo kanalları	79
Abs panoları	80
Abs otomat panoları	81
Pano prizleri	82
Abs pano aksesuarları	83
Pano termostat ve fanları	84
Pano ısıtıcı ve güç kaynakları	93
Polyamid spiral ve aksesuarları	95
Süper etanj plastik rakorlar	95
Kablo bağları ve yapışkan kroşeler	96
Pano spiralleri	97
Ray klemensler ve dağıtım üniteleri	98
Geçmeli ve tırnaklı tip buat klemensler	100
Klemensler	100
Yüksükler	101
Baralar	102
Skp çeşitleri	103
Sanayi tipi kauçuk fiş ve prizleri	104
Cee norm fiş ve prizler	106
Termoplastik buatlar ve kombinasyon kutuları	110
Kombinasyon panoları	112
Sinyal ve kumanda butonları	114
Kumanda ve vinç kutuları	115
Butonlar ve potansiyometre	117
Ampermetre ve voltmetre	125
İkaz lambaları ve sirenler	127



ANAHTAR PRİZ GRUBU

YENİ RENKLER YENİ BAŞLANGIÇLAR



««« Rita
SERİSİ

ANTRASİT



Ritä



Modern tasarımlar,
kusursuz çözümler...



**ANAHTAR
GRUBU
VİDALI TİP**



2220 401 02XX Anahtar
2220 402 02XX Komütatör
2220 403 02XX Vavien (İki Yollu Anahtar)
2220 404 02XX Komütatör Vavien
2220 405 02XX Çift Kutuplu Anahtar
2220 406 02XX Jaluzi Anahtar
2220 407 02XX Çağırma
2220 407 02XXK Kapı Otomatiji Anahtar



2220 407 02XXZ Zil Anahtar
2220 408 02XX Deviyatör(Ara Vavien)
2220 409 02XX Üçlü Anahtar
2220 411 02XX Şofben Anahtar
2220 415 02XX Işıklı Anahtar (220V)
2220 416 02XX Işıklı Vavien (220V)
2220 417 02XX Işıklı Çağırma (220V)
2220 418 02XX Işıklı Etik. Anahtar (220V)
2220 419 02XX Işıklı Etik. Çağırma (220V)

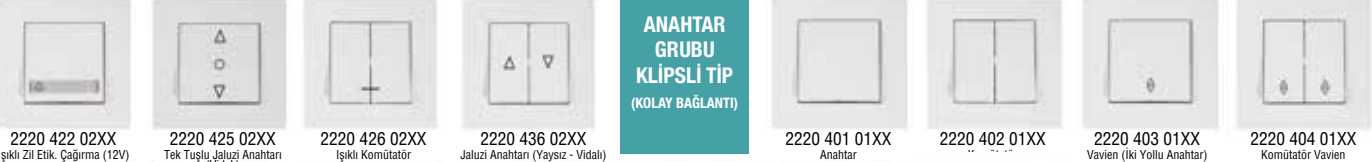

2220 422 02XX Işıklı Zil Etik. Çağırma (12V)
2220 425 02XX Tek Tuşlu Jaluzi Anahtar (Vidalı)
2220 426 02XX Işıklı Komütatör
2220 436 02XX Jaluzi Anahtar (Yaysız - Vidalı)
2220 401 01XX Anahtar
2220 402 01XX
2220 403 01XX Vavien (İki Yollu Anahtar)
2220 404 01XX Komütatör Vavien

**ANAHTAR
GRUBU
KLİPSLİ TİP
(KOLAY BAĞLANTI)**



2220 405 01XX Çift Kutuplu Anahtar
2220 406 01XX Jaluzi Anahtar
2220 407 01XX Çağırma
2220 407 01XXK Kapı Otomatiji Anahtar
2220 407 01XXZ Zil Anahtar
2220 408 01XX Deviyatör(Ara Vavien)
2220 409 01XX Üçlü Anahtar
2220 415 01XX Işıklı Anahtar (220V)
2220 416 01XX Işıklı Vavien (220V)



2220 417 01XX Işıklı Çağırma (220V)
2220 418 01XX Işıklı Etik. Anahtar (220V)
2220 419 01XX Işıklı Etik. Çağırma (220V)
2220 422 01XX Işıklı Zil Etik. Çağırma (12V)
2220 426 01XX Işıklı Komütatör
2220 436 01XX Jaluzi Anahtar (Yaysız - Klipsli)
2220 440 02XX RL Işıklı Dimmer 600W
2220 444 02XX RL Işıklı Dimmer 1000W

**DİMMER
GRUBU**



2220 447 02XX RC Dimmer 325W
2220 450 01XX Energy Saver G.sız Işıklı
2220 452 01XX Energy Saver Gecikmeli Işıklı
2220 470 02XX Müzik Yayın Anahtar
2220 480 01XX Hoparlör Prizi
2220 485 02XX Uyarı Zili
2220 495 02XX Hareket Sensörü

**ELEKTRONİK
GRUBU**

**PRİZ
GRUBU**



2220 600 02XX Tonraklı Priz
2220 601 02XX Tonraksız Priz
2220 605 02XX Tonraklı Priz (Çocuk Kor.)
2220 606 02XX Tonraksız Priz (Çocuk Kor.)
2220 610 02XX Kapaklı Tonraklı Priz
2220 611 02XX Kapaklı Tonraklı Priz (Çoc. Kor.)
2220 615 02XX Ups (Fransız) Priz
2220 616 02XX Ups (Fransız) Priz (Çoc. Kor.)
2220 617 02XX Ups Kapaklı (Fransız) Priz



2220 618 02XX Ups Kapaklı (Fr.) Priz (Çoc. Kor.)
2220 448 01XX Tekli Usb Şarj Prizi
2220 449 01XX İkili Usb Şarj Prizi
2220 200 02XX İkili Tonraklı Priz Porselen
2220 201 02XX İkili Tonraksız Priz Porselen
2220 202 02XX İkili Tonraklı Priz
2220 203 02XX İkili Tonraksız Priz

**İLETİŞİM
GRUBU**

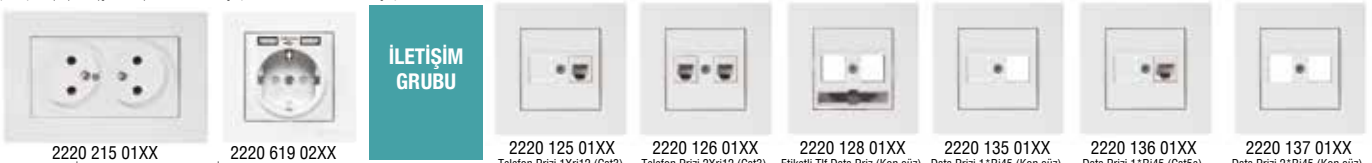

2220 215 01XX İkili Ups Priz
2220 619 02XX İkili Usb (2,4A) Tonraklı Priz
2220 125 01XX Telefon Priz 1X12 (Cat3)
2220 126 01XX Telefon Priz 2X12 (Cat3)
2220 128 01XX Etiketli T11 Data Priz (Kon.süz)
2220 135 01XX Data Priz 1*Rj45 (Kon.süz)
2220 136 01XX Data Priz 1*Rj45 (Cat5e)
2220 137 01XX Data Priz 2*Rj45 (Kon.süz)



2220 139 01XX T11 Data Priz (Rj12 Cat3 + Cat5e)
2220 138 01XX Data Priz 2*Rj45 (Cat5e)
2220 140 01XX Data Priz 1*Rj45 (Cat6)
2220 141 01XX Data Priz 2*Rj45 (Cat6)
2220 455 01XX Data Priz 1*Usb
2220 456 01XX Data Priz 2*Usb
2220 457 01XX Data Priz 1*Hdmi
2220 458 01XX Data Priz 2*Hdmi
2220 459 01XX Data Priz 1*Usb/1*Hdmi

**TV / SAT
GRUBU**



2220 460 01XX VGA Priz
2220 461 01XX İki Çıkışlı Fiber Optik Priz
2220 121 02XX Kör Kapak
2220 156 02XX Tv-Sat Priz (Geçişli) 4DB/F Kon.
2220 157 02XX Tv-Sat Priz (Sontlu)
2220 166 01XX Sat Priz (Geçişli) 4DB/F Kon.
2220 167 01XX Sat Priz (Sontlu)
2220 170 01XX Tv Priz (Geçişli) 11DB



2220 171 01XX Tv Priz (Sontlu)
2220 172 01XX Tv Priz F Dışı



NATURAL



01 - BEYAZ



02 - KREM

AHŞAP



56 - KIRAZ



57 - CEVİZ



58 - MEŞE

METALİK



80 - A.ALTIN



82 - İNOX



83 - TİTANYUM



84 - SİYAH



85 - DORE



86 - ANTRASİT



95 - FÜME

YENİ
RENKİMİZ

PASTEL



03 - GRİ



04 - KIRMIZI



06 - TURUNCU



08 - SARI



09 - LACİVERT



10 - YEŞİL



11 - PEMBE



12 - MAVİ



25 - MOR

Kod	Ürün Tanımı	Kutu Adedi	Koli Adedi	Beyaz/Krem Fiyat	Metalik Fiyat	Ahşap Fiyat
-----	-------------	------------	------------	------------------	---------------	-------------

Anahtar Grubu Vidalı Tip

2200 401 02XX	Mek+Tuş Anahtar (Vidalı)	12	120	59,44	76,86	93,43
2200 402 02XX	Mek+Tuş Komütatör (Vidalı)	12	120	76,82	93,04	107,65
2200 403 02XX	Mek+Tuş Vavien (İki Yollu Anahtar)(Vidalı)	12	120	77,88	92,04	104,93
2200 404 02XX	Mek+Tuş Komütatör Vavien (Vidalı)	12	120	132,07	151,85	161,42
2200 405 02XX	Mek+Tuş Çift Kutuplu Anahtar (Vidalı)	12	120	88,68	103,15	112,45
2200 406 02XX	Mek+Tuş Jalu Anahtarı (Vidalı)	12	120	114,85	141,60	147,32
2200 407 02XX	Mek+Tuş Çağırma (Vidalı)	12	120	70,06	83,19	98,97
2200 407 02XXK	Mek+Tuş Kapı Otomatığı Anahtarı (Vidalı)	12	120	70,06	83,19	98,97
2200 407 02XXZ	Mek+Tuş Zil Anahtarı (Vidalı)	12	120	70,06	83,19	98,97
2200 408 02XX	Mek+Tuş Deviatör(Ara Vavien)(Vidalı)	12	120	126,24	154,02	164,44
2200 409 02XX	Mek+Tuş Üçlü Anahtar (Vidalı)	12	120	110,67	128,34	167,29
2200 411 02XX	Mek+Tuş Şofben Anahtarı (Vidalı)	12	120	112,45	140,76	152,93
2200 415 02XX	Mek+Tuş Işıklı Anahtar (220V) (Vidalı)	12	120	111,72	132,51	142,44
2200 416 02XX	Mek+Tuş Işıklı Vavien (220V) (Vidalı)	12	120	141,95	162,90	170,17
2200 417 02XX	Mek+Tuş Işıklı Çağırma (220V)(Vidalı)	12	120	113,90	143,90	161,31
2200 418 02XX	Mek+Tuş Işıklı Etik. Anahtar (220V)(Vidalı)	12	120	130,72	137,03	155,46
2200 419 02XX	Mek+Tuş Işıklı Etik. Çağırma (220V)(Vidalı)	12	120	131,47	137,16	158,32
2200 422 02XX	Mek+Tuş Işıklı Zil Etik. Çağırma (12V)(Vidalı)	12	120	171,57	191,94	219,10
2200 425 02XX	Mek+Tuş Tek Tuşlu Jalu Anahtarı (Vidalı)	12	120	140,47	173,77	181,25
2200 426 02XX	Mek+Tuş Işıklı Komütatör (Vidalı)	12	120	150,36	184,51	192,81
2200 436 02XX	Mek+Tuş Jalu Anahtarı (Yaysız)(Vidalı)	12	120	140,47	181,42	175,00



* Çoklu çerçeve ile kullanılamaz.



Anahtar Grubu Klipsli Tip (Kolay Bağlantı)

2200 401 01XX	Mek+Tuş Anahtar (Klipsli)	12	120	59,44	76,86	93,43
2200 402 01XX	Mek+Tuş Komütatör (Klipsli)	12	120	76,82	93,04	107,65
2200 403 01XX	Mek+Tuş Vavien (İki Yollu Anahtar)(Klipsli)	12	120	77,88	92,04	104,93
2200 404 01XX	Mek+Tuş Komütatör Vavien (Klipsli)	12	120	132,07	151,85	161,42
2200 405 01XX	Mek+Tuş Çift Kutuplu Anahtar (Klipsli)	12	120	88,68	103,15	112,45
2200 406 01XX	Mek+Tuş Jalu Anahtarı (Klipsli)	12	120	114,85	141,60	147,32
2200 407 01XX	Mek+Tuş Çağırma (Klipsli)	12	120	70,06	83,19	98,97
2200 407 01XXK	Mek+Tuş Kapı Otomatığı Anahtarı (Klipsli)	12	120	70,06	83,19	98,97
2200 407 01XXZ	Mek+Tuş Zil Anahtarı (Klipsli)	12	120	70,06	83,19	98,97
2200 408 01XX	Mek+Tuş Deviatör(Ara Vavien)(Klipsli)	12	120	126,24	154,02	164,44
2200 409 01XX	Mek+Tuş Üçlü Anahtar (Klipsli)	12	120	110,67	128,34	167,29
2200 415 01XX	Mek+Tuş Işıklı Anahtar (220V) (Klipsli)	12	120	111,72	132,51	142,44
2200 416 01XX	Mek+Tuş Işıklı Vavien (220V) (Klipsli)	12	120	141,95	162,90	170,17
2200 417 01XX	Mek+Tuş Işıklı Çağırma (220V)(Klipsli)	12	120	113,90	143,90	161,31
2200 418 01XX	Mek+Tuş Işıklı Etik. Anahtar (220V)(Klipsli)	12	120	130,72	137,03	155,46
2200 419 01XX	Mek+Tuş Işıklı Etik. Çağırma (220V)(Klipsli)	12	120	131,47	137,16	158,32
2200 422 01XX	Mek+Tuş Işıklı Zil Etik. Çağırma (12V)(Klipsli)	12	120	171,57	191,94	219,10
2200 426 01XX	Mek+Tuş Işıklı Komütatör (Klipsli)	12	120	150,36	184,51	192,81
2200 436 01XX	Mek+Tuş Jalu Anahtarı (Yaysız)(Klipsli)	12	120	140,47	181,42	175,00

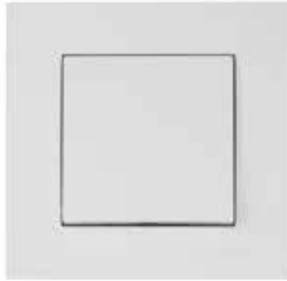

Dimmer Grubu

2200 440 02XX	Mek+Tuş RL Işıklı Dimmer 600W	8	80	345,87	426,93	520,21
2200 444 02XX	Mek+Tuş RL Işıklı Dimmer 1000W	8	80	437,09	676,18	736,16
2200 447 02XX	Mek+Tuş RC Dimmer 325W	8	80	874,49	1.581,19	1.733,33

Elektronik Grubu

2200 450 01XX	Mek+Tuş Energy Saver G.siz Işıklı	8	80	491,10	563,36	603,38
2200 452 01XX	Mek+Tuş Energy Saver Gecikmeli Işıklı	8	80	510,74	583,48	611,70
2200 470 02XX	Mek+Tuş Müzik Yayın Anahtarı	8	80	683,91	717,54	757,09
2200 480 01XX	Mek+Tuş Hoparlör Prizi	8	80	156,98	245,36	267,36
2200 485 02XX	Mek+Tuş Uyarı Zili	8	80	861,37	921,73	945,19
2200 495 02XX	Mek+Tuş Hareket Sensörü	8	80	1.081,61	1.261,09	1.399,19

Priz Grubu

2200 600 02XX	Mek+Tuş Topraklı Priz	12	120	82,06	108,90	121,89
2200 601 02XX	Mek+Tuş Topraksız Priz	12	120	65,95	103,36	114,05
2200 605 02XX	Mek+Tuş Topraklı Priz (Çocuk Kor.)	12	120	91,64	142,44	158,78
2200 606 02XX	Mek+Tuş Topraksız Priz (Çocuk Kor.)	12	120	76,04	123,45	135,44
2200 610 02XX	Mek+Tuş Kapaklı Topraklı Priz	12	120	93,03	119,26	132,14
2200 611 02XX	Mek+Tuş Kapaklı Topraklı Priz (Çoc. Kor.)	12	120	104,11	139,46	159,19
2200 615 02XX	Mek+Tuş Ups (Fransız) Prizi	12	120	97,42	172,91	187,72
2200 616 02XX	Mek+Tuş Ups (Fransız) Prizi (Çoc. Kor.)	12	120	117,17	173,88	188,68
2200 617 02XX	Mek+Tuş Ups Kapaklı (Fransız) Priz	12	120	105,81	163,01	181,67
2200 618 02XX	Mek+Tuş Ups Kapaklı (Fr.) Priz (Çoc. Kor.)	12	120	118,76	168,43	187,42
2200 200 02XX	Mek+Tuş İkili Topraklı Priz Porselen	5	50	154,71	186,92	229,51
2200 201 02XX	Mek+Tuş İkili Topraksız Priz Porselen	5	50	118,18	152,36	183,86
2200 202 02XX	Mek+Tuş İkili Topraklı Priz	5	50	142,93	186,92	227,68
2200 203 02XX	Mek+Tuş İkili Topraksız Priz	5	50	114,22	147,33	184,04
2200 215 02XX	Mek+Tuş İkili Ups Priz	5	50	123,48	142,53	171,98
2200 448 01XX	Mek+Tuş Tekli Usb Şarj Prizi	5	50	322,78	391,55	429,05
2200 449 01XX	Mek+Tuş İkili Usb Şarj Prizi	5	50	409,71	448,72	538,67
2220 619 02XX	İkili Usb Topraklı Priz (Çerçeve Dahil)	8	-	495,47	865,82	913,07



Kod	Ürün Tanımı	Kutu Adedi	Koli Adedi	Beyaz/Krem Fiyat	Metalik Fiyat	Ahşap Fiyat
-----	-------------	------------	------------	------------------	---------------	-------------



İletişim Grubu

2200 125 01XX	Mek+Tuş Telefon Prizi 1Xrj12 (Cat3)	12	120	94,68	115,36	129,40
2200 126 01XX	Mek+Tuş Telefon Prizi 2Xrj12 (Cat3)	12	120	141,61	157,40	181,65
2200 128 01XX	Mek+Tuş Etiketli Tlf Data Priz (Kon.süz)	12	120	71,98	89,00	105,20
2200 135 01XX	Mek+Tuş Data Prizi 1*Rj45 (Kon.süz)	12	120	51,41	70,25	84,63
2200 136 01XX	Mek+Tuş Data Prizi 1*Rj45 (Cat5e)	12	120	140,10	215,64	239,16
2200 137 01XX	Mek+Tuş Data Prizi 2*Rj45 (Kon.süz)	12	120	55,91	68,84	83,56
2200 138 01XX	Mek+Tuş Data Prizi 2*Rj45 (Cat5e)	12	120	224,05	332,72	362,85
2200 139 01XX	Mek+Tuş Tlf Data Priz (Rj12 Cat3 + Cat5e)	12	120	190,97	302,16	330,64
2200 140 01XX	Mek+Tuş Data Prizi 1*Rj45 (Cat6)	12	120	172,57	241,28	261,11
2200 141 01XX	Mek+Tuş Data Prizi 2*Rj45 (Cat6)	12	120	310,39	380,78	416,00
2200 455 01XX	Mek+Tuş Data Prizi 1*Usb	12	120	238,66	259,05	275,35
2200 456 01XX	Mek+Tuş Data Prizi 2*Usb	12	120	416,97	449,29	467,50
2200 457 01XX	Mek+Tuş Data Prizi 1*Hdmı	12	120	325,94	335,38	369,00
2200 458 01XX	Mek+Tuş Data Prizi 2*Hdmı	12	120	584,19	612,59	638,10
2200 459 01XX	Mek+Tuş Data Prizi 1*Usb/1*Hdmı	12	120	502,18	514,94	550,61
2200 460 01XX	Mek+Tuş VGA Priz	12	120	508,23	665,08	709,08
2200 147 01XX	Mek+Tuş Bir Çıkışlı Fiber Optik Priz (RJ45)	12	120	163,40	215,82	243,12
2200 461 01XX	Mek+Tuş İki Çıkışlı Fiber Optik Priz	12	120	190,24	236,16	258,33
2200 121 02XX	Mek+Tuş Kör Kapak	12	120	45,32	95,82	103,53

TV / SAT Grubu

2200 156 02XX	Mek+Tuş Tv-Sat Prizi (Geçişli) 4DB/F Kon.	12	120	353,42	453,99	558,29
2200 157 02XX	Mek+Tuş Tv-Sat Prizi (Sonlu)	12	120	354,00	454,40	531,57
2200 166 01XX	Mek+Tuş Sat Prizi (Geçişli) 4DB/F Kon.	12	120	187,40	274,84	319,21
2200 167 01XX	Mek+Tuş Sat Prizi (Sonlu)	12	120	187,40	274,84	319,21
2200 170 01XX	Mek+Tuş Tv Prizi (Geçişli) 11DB	12	120	153,11	202,53	219,67
2200 171 01XX	Mek+Tuş Tv Prizi (Sonlu)	12	120	153,59	202,95	220,71
2200 172 01XX	Mek+Tuş Tv Prizi F Dişi	12	120	81,59	84,60	95,32

Çerçeveler

2220 800 11XX	Tekli Çerçeve	20	400	8,90	22,81	30,87
2220 800 12XX	İkili Yatay Çerçeve	10	200	39,30	54,11	59,72
2220 800 13XX	Üçlü Yatay Çerçeve	10	50	49,48	78,30	113,94
2220 800 14XX	Dörtlü Yatay Çerçeve	10	50	84,30	123,42	131,90
2220 800 15XX	Beşli Yatay Çerçeve	10	50	96,80	174,33	190,59
2220 800 16XX	Altılı Yatay Çerçeve	10	50	103,28	192,22	220,04
2220 800 22XX	İkili Dikey Çerçeve	10	50	39,30	54,11	59,72
2220 800 23XX	Üçlü Dikey Çerçeve	10	50	49,48	78,30	113,94
2220 800 24XX	Dörtlü Dikey Çerçeve	10	50	84,30	123,42	131,90
2220 800 25XX	Beşli Dikey Çerçeve	10	50	96,80	174,33	190,59
2220 800 26XX	Altılı Dikey Çerçeve	10	50	103,28	192,22	220,04
2220 820 12XX	İkili Priz Çerçeve	12	60	25,76	39,28	61,61
2100 000 11XX	Sıva Üstü Kasa	12	60	36,87	81,84	111,65
2200 000 11XX	Sıva Üstü Anahtar Kasası (Geçmeli)	-	-	61,66	90,38	124,76
2200 800 00XX	Telefon Tutucu	24	240	15,99	-	-
2200 000 0001	IP44 Kapaklı Priz Conta (Resmi Sayfa 30'da)	24	120	15,47	-	-

RİTA PASTEL

Çerçeveler

Çerçeve	Kutu Adedi	Koli Adedi	Pastel Fiyat	
2220 800 11XX	Tekli Çerçeve	20	400	14,07
2220 800 12XX	İkili Yatay Çerçeve	10	200	57,52
2220 800 13XX	Üçlü Yatay Çerçeve	10	50	94,67
2220 800 14XX	Dörtlü Yatay Çerçeve	10	50	118,33
2220 800 15XX	Beşli Yatay Çerçeve	10	50	130,37
2220 800 16XX	Altılı Yatay Çerçeve	10	50	149,00
2220 800 22XX	İkili Dikey Çerçeve	10	50	57,52
2220 800 23XX	Üçlü Dikey Çerçeve	10	50	94,67
2220 800 24XX	Dörtlü Dikey Çerçeve	10	50	118,33
2220 800 25XX	Beşli Dikey Çerçeve	10	50	130,37
2220 800 26XX	Altılı Dikey Çerçeve	10	50	149,00

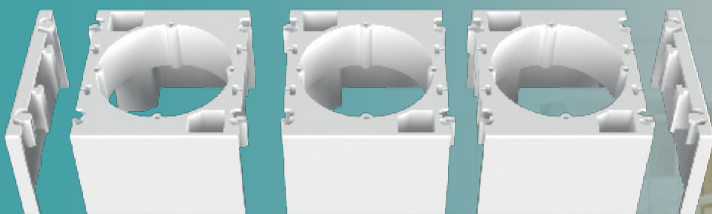

Sıva üstü kasa uygulaması ile istediğiniz kadar "Anahtar Priz Uygulaması" yapabilirsiniz.



Elitra | Plus

Uyum ve zarafet
bir arada...



Elitra | Plus

Elitra Glass



XXX-811



XXX-814

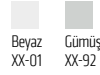

BEYAZ / SİYAH

Kod	Ürün Tanımı	Kutu Adedi	Fiyat
2170 XXX 11XX	Tekli Çerçeve	10	382,32
2170 XXX 12XX	Yatay İkili Çerçeve	10	722,38
2170 XXX 13XX	Yatay Üçlü Çerçeve	10	1.468,43
2170 XXX 14XX	Yatay Dörtlü Çerçeve	10	1.595,74
2170 XXX 15XX	Yatay Beşli Çerçeve	10	2.636,43
2170 XXX 22XX	Dikey İkili Çerçeve	10	722,38
2170 XXX 23XX	Dikey Üçlü Çerçeve	10	1.468,43
2170 XXX 24XX	Dikey Dörtlü Çerçeve	10	1.595,74
2170 XXX 25XX	Dikey Beşli Çerçeve	10	2.636,43

Elitra Chrome



XXX-821



XXX-822



XXX-824

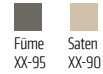

KROM / PASLANMAZ ÇELİK / ALTIN

Kod	Ürün Tanımı	Kutu Adedi	Fiyat
2170 XXX 11XX	Tekli Çerçeve	10	741,61
2170 XXX 12XX	Yatay İkili Çerçeve	10	1.090,98
2170 XXX 13XX	Yatay Üçlü Çerçeve	10	1.511,33
2170 XXX 14XX	Yatay Dörtlü Çerçeve	10	1.704,39
2170 XXX 15XX	Yatay Beşli Çerçeve	10	2.077,76
2170 XXX 16XX	Yatay Altılı Çerçeve	10	2.797,94
2170 XXX 22XX	Dikey İkili Çerçeve	10	1.090,98
2170 XXX 23XX	Dikey Üçlü Çerçeve	10	1.511,33
2170 XXX 24XX	Dikey Dörtlü Çerçeve	10	1.704,39
2170 XXX 25XX	Dikey Beşli Çerçeve	10	2.077,76
2170 XXX 26XX	Dikey Altılı Çerçeve	10	2.797,94



XXX-825



XXX-825



FÜME XX-95
GÜMÜŞ XX-92

GÜMÜŞ - PARLAK FÜME

Kod	Ürün Tanımı	Kutu Adedi	Fiyat
2170 825 11XX	Tekli Çerçeve	10	452,65
2170 825 12XX	Yatay İkili Çerçeve	10	807,00
2170 825 13XX	Yatay Üçlü Çerçeve	10	1.199,53
2170 825 14XX	Yatay Dörtlü Çerçeve	10	1.367,55
2170 825 15XX	Yatay Beşli Çerçeve	10	1.656,04
2170 825 16XX	Yatay Altılı Çerçeve	10	1.922,62
2170 825 22XX	Dikey İkili Çerçeve	10	807,00
2170 825 23XX	Dikey Üçlü Çerçeve	10	1.199,53
2170 825 24XX	Dikey Dörtlü Çerçeve	10	1.367,55
2170 825 25XX	Dikey Beşli Çerçeve	10	1.656,04
2170 825 26XX	Dikey Altılı Çerçeve	10	1.922,62

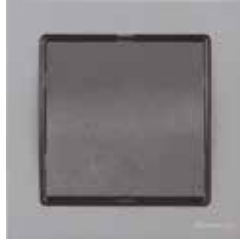

XXX-827



XXX-828



FÜME XX-95
SATEN XX-90

MAT ALÜMİNYUM - MAT SATEN

Kod	Ürün Tanımı	Kutu Adedi	Fiyat
2170 XXX 11XX	Tekli Çerçeve	10	435,60
2170 XXX 12XX	Yatay İkili Çerçeve	10	669,75
2170 XXX 13XX	Yatay Üçlü Çerçeve	10	935,80
2170 XXX 14XX	Yatay Dörtlü Çerçeve	10	1.067,56
2170 XXX 15XX	Yatay Beşli Çerçeve	10	1.693,03
2170 XXX 16XX	Yatay Altılı Çerçeve	10	2.407,10
2170 XXX 22XX	Dikey İkili Çerçeve	10	669,75
2170 XXX 23XX	Dikey Üçlü Çerçeve	10	935,80
2170 XXX 24XX	Dikey Dörtlü Çerçeve	10	1.067,56
2170 XXX 25XX	Dikey Beşli Çerçeve	10	1.693,03
2170 XXX 26XX	Dikey Altılı Çerçeve	10	2.407,10



KAYIN / KIRAZ / VENGE

Kod	Ürün Tanımı	Kutu Adedi	Fiyat
2170 XXX 11XX	Tekli Çerçeve	10	481,67
2170 XXX 12XX	Yatay İkili Çerçeve	10	840,86
2170 XXX 13XX	Yatay Üçlü Çerçeve	10	1.215,66
2170 XXX 14XX	Yatay Dörtlü Çerçeve	10	1.242,07
2170 XXX 15XX	Yatay Beşli Çerçeve	10	1.404,48
2170 XXX 22XX	Dikey İkili Çerçeve	10	840,86
2170 XXX 23XX	Dikey Üçlü Çerçeve	10	1.215,66
2170 XXX 24XX	Dikey Dörtlü Çerçeve	10	1.242,07
2170 XXX 25XX	Dikey Beşli Çerçeve	10	1.404,48

Elitra Marble

BLACK QUARTZ / SAND STONE



Kod	Ürün Tanımı	Kutu Adedi	Fiyat
2170 XXX 11XX	Tekli Çerçeve	10	598,07
2170 XXX 12XX	Yatay İkili Çerçeve	10	698,76
2170 XXX 13XX	Yatay Üçlü Çerçeve	10	1.090,64
2170 XXX 14XX	Yatay Dörtlü Çerçeve	10	1.244,35
2170 XXX 15XX	Yatay Beşli Çerçeve	10	1.566,08
2170 XXX 22XX	Dikey İkili Çerçeve	10	698,28
2170 XXX 23XX	Dikey Üçlü Çerçeve	10	1.089,68
2170 XXX 24XX	Dikey Dörtlü Çerçeve	10	1.243,11
2170 XXX 25XX	Dikey Beşli Çerçeve	10	1.564,39

Elitra Ale

NATURAL / SATEN / MAT FÜME



Kod	Ürün Tanımı	Kutu Adedi	Fiyat
2170 XXX 11XX	Tekli Çerçeve	10	377,84
2170 XXX 12XX	Yatay İkili Çerçeve	10	666,19
2170 XXX 13XX	Yatay Üçlü Çerçeve	10	1.074,89
2170 XXX 14XX	Yatay Dörtlü Çerçeve	10	1.370,37
2170 XXX 15XX	Yatay Beşli Çerçeve	10	1.677,07
2170 XXX 16XX	Yatay Altılı Çerçeve	10	3.130,59
2170 XXX 22XX	Dikey İkili Çerçeve	10	666,19
2170 XXX 23XX	Dikey Üçlü Çerçeve	10	1.074,89
2170 XXX 24XX	Dikey Dörtlü Çerçeve	10	1.370,37
2170 XXX 25XX	Dikey Beşli Çerçeve	10	1.677,07
2170 XXX 26XX	Dikey Altılı Çerçeve	10	3.130,59

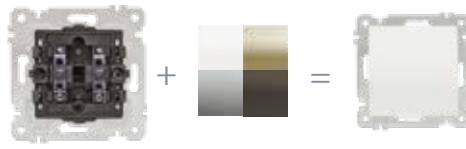

Kod	Ürün Tanımı	Kutu Adedi	Fiyat
Anahtar Grubu Vidalı Tip			
2270 401 02XX	Mek+Tuş Anahtar	12	76,86
2270 402 02XX	Mek+Tuş Komütatör	12	93,04
2270 403 02XX	Mek+Tuş Vavien (İki Yollu Anahtar)	12	92,04
2270 404 02XX	Mek+Tuş Komütatör Vavien	12	151,85
2270 405 02XX	Mek+Tuş Çift Kutuplu Anahtar	12	103,15
2270 406 02XX	Mek+Tuş Jaluzi Anahtarı-Yaylı	12	141,60
2270 407 02XX	Mek+Tuş Light (Çağırma)	12	83,19
2270 407 02XXZ	Mek+Tuş Zil Anahtarı	12	83,19
2270 407 02XXK	Mek+Tuş Kapı Otomatığı Anahtarı	12	83,19
2270 408 02XX	Mek+Tuş Deviatör (Ara Vavien)	12	154,02
2270 409 02XX	Mek+Tuş Üçlü Anahtar	12	128,34
2270 411 02XX	Mek+Tuş Şöfben Anahtarı	12	140,76
2270 415 02XX	Mek+Tuş Işıklı Anahtar (220V)	12	132,51
2270 416 02XX	Mek+Tuş Işıklı Vavien (220V)	12	162,90
2270 417 02XX	Mek+Tuş Işıklı Çağırma (220V)	12	143,90
2270 418 02XX	Mek+Tuş Işıklı Etiketli Anahtar (220V)	12	137,03
2270 419 02XX	Mek+Tuş Işıklı Etiketli Çağırma (220V)	12	137,16
2270 422 02XX	Mek+Tuş Işıklı Zil Etiketli Çağırma (12V)	12	191,94
2270 426 02XX	Mek+Tuş Işıklı Komütatör	12	184,51
Anahtar Grubu Klipsli Tip (Kolay Bağlantı)			
2270 401 01XX	Mek+Tuş Anahtar	12	76,86
2270 402 01XX	Mek+Tuş Komütatör	12	93,04
2270 403 01XX	Mek+Tuş Vavien (İki Yollu Anahtar)	12	92,04
2270 404 01XX	Mek+Tuş Komütatör Vavien	12	151,85
2270 405 01XX	Mek+Tuş Çift Kutuplu Anahtar	12	103,15
2270 406 01XX	Mek+Tuş Jaluzi Anahtarı-Yaylı	12	141,60
2270 407 01XX	Mek+Tuş Light (Çağırma)	12	83,19
2270 407 01XXZ	Mek+Tuş Zil Anahtarı	12	83,19
2270 407 01XXK	Mek+Tuş Kapı Otomatığı Anahtarı	12	83,19
2270 408 01XX	Mek+Tuş Deviatör (Ara Vavien)	12	154,02
2270 409 01XX	Mek+Tuş Üçlü Anahtar	12	128,34
2270 415 01XX	Mek+Tuş Işıklı Anahtar (220V)	12	132,51
2270 416 01XX	Mek+Tuş Işıklı Vavien (220V)	12	162,90
2270 417 01XX	Mek+Tuş Işıklı Çağırma (220V)	12	143,90
2270 418 01XX	Mek+Tuş Işıklı Etiketli Anahtar (220V)	12	137,03
2270 419 01XX	Mek+Tuş Işıklı Etiketli Çağırma (220V)	12	137,16
2270 422 01XX	Mek+Tuş Işıklı Zil Etiketli Çağırma (12V)	12	191,94
2270 426 01XX	Mek+Tuş Işıklı Komütatör	12	184,51
Dimmer Grubu			
2270 440 02XX	Mek+Tuş Işıklı Dimmer 600W	8	426,93
2270 444 02XX	Mek+Tuş Işıklı Dimmer 1000W	8	676,18
2270 447 02XX	Mek+Tuş RC Dimmer 325W	8	1.581,19
Elektronik Grubu			
2270 450 01XX	Mek+Tuş Energy Saver Gecikmesiz Işıklı	8	563,36
2270 452 01XX	Mek+Tuş Energy Saver Gecikmeli	8	583,48
2270 470 02XX	Mek+Tuş Müzik Yayın Anahtarı	8	717,54
2270 480 01XX	Mek+Tuş Hoparlör Prizi	8	245,36
2270 485 02XX	Mek+Tuş Uyarı Zili	8	921,73
2270 495 02XX	Mek+Tuş Hareket Sensörü	8	1.261,09
Priz Grubu			
2270 600 02XX	Mek+Tuş Topraklı Priz	12	108,90
2270 601 02XX	Mek+Tuş Topraksız Priz	12	103,36
2270 605 02XX	Mek+Tuş Topraklı Priz (Çocuk Korumalı)	12	142,44
2270 606 02XX	Mek+Tuş Topraksız Priz (Çocuk Korumalı)	12	123,45
2270 610 02XX	Mek+Tuş Kapaklı Topraklı Priz	12	119,26
2270 611 02XX	Mek+Tuş Kapaklı Topraklı Priz (Çocuk Korumalı)	12	139,46
2270 615 02XX	Mek+Tuş Ups (Fransız) Prizi	12	172,91
2270 616 02XX	Mek+Tuş Ups (Fransız) Prizi(Çocuk Korumalı)	12	173,88
2270 617 02XX	Mek+Tuş Ups Kapaklı (Fransız) Priz	12	163,01
2270 618 02XX	Mek+Tuş Ups Kap. (Fransız) Priz (Çocuk Korumalı)	12	168,43
2270 121 02XX	Mek+Tuş Kör Kapak	12	95,82
2270 448 01XX	Mek+Tuş Tekli Usb Şarj Prizi	5	391,55
2270 449 01XX	Mek+Tuş İkili Usb Şarj Prizi	5	448,72
İletişim Grubu			
2270 455 01XX	Mek+Tuş Data Prizi 1*Usb	12	259,05
2270 456 01XX	Mek+Tuş Data Prizi 2*Usb	12	449,29
2270 457 01XX	Mek+Tuş Data Prizi 1*Hdmi	12	335,38
2270 458 01XX	Mek+Tuş Data Prizi 2*Hdmi	12	612,59
2270 459 01XX	Mek+Tuş Data Prizi 1*Usb/1*Hdmi	12	514,94
2270 125 01XX	Mek+Tuş Telefon Prizi 1*Rj12 Cat3	12	115,36
2270 126 01XX	Mek+Tuş Telefon Prizi 2*Rj12 Cat3	12	157,40
2270 128 01XX	Mek+Tuş Etiketli Tlf+Data Priz (Kon.süz)	12	89,00
2270 135 01XX	Mek+Tuş Data Prizi 1*Rj45 (Kon.süz)	12	70,25
2270 136 01XX	Mek+Tuş Data Prizi 1*Rj45 (Cat5e)	12	215,64
2270 137 01XX	Mek+Tuş Data Prizi 2*Rj45 (Kon.süz)	12	68,84
2270 138 01XX	Mek+Tuş Data Prizi 2*Rj45 (Cat5e)	12	332,72
2270 139 01XX	Mek+Tuş Tlf+Data Priz (Rj12 Cat3+Cat5e)	12	302,16
2270 140 01XX	Mek+Tuş Data Prizi 1*Rj45 (Cat6)	12	241,28
2270 141 01XX	Mek+Tuş Data Prizi 2*Rj45 (Cat6)	12	380,78
TV / SAT Grubu			
2270 156 02XX	Mek+Tuş Tv-Sat Prizi (Geçişli) 4DB/F Kon.	12	453,99
2270 157 02XX	Mek+Tuş Tv-Sat Prizi (Sonlu)	12	454,40
2270 166 01XX	Mek+Tuş Sat Prizi (Geçişli) 4DB/F Konnektör	12	274,84
2270 167 01XX	Mek+Tuş Sat Prizi (Sonlu)	12	274,84
2270 170 01XX	Mek+Tuş Tv Prizi (Geçişli) 11DB	12	202,53
2270 171 01XX	Mek+Tuş Tv Prizi (Sonlu)	12	202,95
2270 172 01XX	Mek+Tuş Tv Prizi F Dışı	12	84,60



Candelä

Şık Çözümler için...



ANAHTAR GRUBU VIDALI TİP



ANAHTAR GRUBU KLİPSLİ TİP (KOLAY BAĞLANTI)



DİMMER GRUBU

ELEKTRONİK GRUBU



PRİZ GRUBU



İLETİŞİM GRUBU



TV / SAT GRUBU



NATURAL



01 -BEYAZ



02 -KREM

AHŞAP



56 -KIRAZ



57 -CEVİZ



58 -MEŞE

METALİK



80 -A.ALTIN



82 -İNOX



83 -TİTANYUM



84 -SİYAH



85 -DORE



95 -FÜME



Kod	Ürün Tanımı	Kutu Adedi	Koli Adedi	Beyaz/Krem Fiyat	Metalik Fiyat	Ahşap Fiyat
-----	-------------	------------	------------	------------------	---------------	-------------

Anahtar Grubu Vidalı Tip

2100 401 02XX	Mek+Tuş Anahtar (Vidalı)	12	120	59,44	76,86	93,43
2100 402 02XX	Mek+Tuş Komütatör (Vidalı)	12	120	76,82	93,04	107,65
2100 403 02XX	Mek+Tuş Vavien (İki Yollu Anahtar)(Vidalı)	12	120	77,88	92,04	104,93
2100 404 02XX	Mek+Tuş Komütatör Vavien (Vidalı)	12	120	132,07	151,85	161,42
2100 405 02XX	Mek+Tuş Çift Kutuplu Anahtar (Vidalı)	12	120	88,68	103,15	112,45
2100 406 02XX	Mek+Tuş Jalu Anahtarı (Vidalı)	12	120	114,85	141,60	147,32
2100 407 02XX	Mek+Tuş Çağırma (Vidalı)	12	120	70,06	83,19	98,97
2100 407 02XXK	Mek+Tuş Kapı Otomatığı Anahtarı (Vidalı)	12	120	70,06	83,19	98,97
2100 407 02XXZ	Mek+Tuş Zil Anahtarı (Vidalı)	12	120	70,06	83,19	98,97
2100 408 02XX	Mek+Tuş Deviatör(Ara Vavien)(Vidalı)	12	120	126,24	154,02	164,44
2100 409 02XX	Mek+Tuş Üçlü Anahtar (Vidalı)	12	120	110,67	128,34	167,29
2100 411 02XX	Mek+Tuş Şofben Anahtarı (Vidalı)	12	120	112,45	140,76	152,93
2100 415 02XX	Mek+Tuş Işıklı Anahtar (220V) (Vidalı)	12	120	111,72	132,51	142,44
2100 416 02XX	Mek+Tuş Işıklı Vavien (220V) (Vidalı)	12	120	141,95	162,90	170,17
2100 417 02XX	Mek+Tuş Işıklı Çağırma (220V) (Vidalı)	12	120	113,90	143,90	161,31
2100 418 02XX	Mek+Tuş Işıklı Etik. Anahtar (220V)(Vidalı)	12	120	130,72	137,03	155,46
2100 419 02XX	Mek+Tuş Işıklı Etik. Çağırma (220V)(Vidalı)	12	120	131,47	137,16	158,32
2100 422 02XX	Mek+Tuş Işıklı Zil Etik. Çağırma (12V)(Vidalı)	12	120	171,57	191,94	219,10
2100 426 02XX	Mek+Tuş Işıklı Komütatör (Vidalı)	12	120	150,36	184,51	192,81
2100 436 02XX	Mek+Tuş Jalu Anahtarı (Yaysız)(Vidalı)	12	120	140,47	181,42	175,00

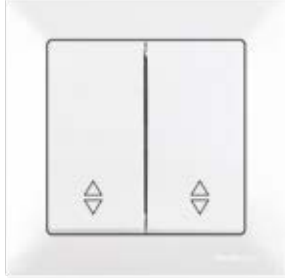

Anahtar Grubu Klipsli Tip (Kolay Bağlantı)

2100 401 01XX	Mek+Tuş Anahtar (Klipsli)	12	120	59,44	76,86	93,43
2100 402 01XX	Mek+Tuş Komütatör (Klipsli)	12	120	76,82	93,04	107,65
2100 403 01XX	Mek+Tuş Vavien (İki Yollu Anahtar)(Klipsli)	12	120	77,88	92,04	104,93
2100 404 01XX	Mek+Tuş Komütatör Vavien (Klipsli)	12	120	132,07	151,85	161,42
2100 405 01XX	Mek+Tuş Çift Kutuplu Anahtar (Klipsli)	12	120	88,68	103,15	112,45
2100 406 01XX	Mek+Tuş Jalu Anahtarı (Klipsli)	12	120	114,85	141,60	147,32
2100 407 01XX	Mek+Tuş Çağırma (Klipsli)	12	120	70,06	83,19	98,97
2100 407 01XXK	Mek+Tuş Kapı Otomatığı Anahtarı (Klipsli)	12	120	70,06	83,19	98,97
2100 407 01XXZ	Mek+Tuş Zil Anahtarı (Klipsli)	12	120	70,06	83,19	98,97
2100 408 01XX	Mek+Tuş Deviatör(Ara Vavien)(Klipsli)	12	120	126,24	154,02	164,44
2100 409 01XX	Mek+Tuş Üçlü Anahtar (Klipsli)	12	120	110,67	128,34	167,29
2100 415 01XX	Mek+Tuş Işıklı Anahtar (220V) (Klipsli)	12	120	111,72	132,51	142,44
2100 416 01XX	Mek+Tuş Işıklı Vavien (220V) (Klipsli)	12	120	141,95	162,90	170,17
2100 417 01XX	Mek+Tuş Işıklı Çağırma (220V)(Klipsli)	12	120	113,90	143,90	161,31
2100 418 01XX	Mek+Tuş Işıklı Etik. Anahtar (220V)(Klipsli)	12	120	130,72	137,03	155,46
2100 419 01XX	Mek+Tuş Işıklı Etik. Çağırma (220V)(Klipsli)	12	120	131,47	137,16	158,32
2100 422 01XX	Mek+Tuş Işıklı Zil Etik. Çağırma (12V)(Klipsli)	12	120	171,57	191,94	219,10
2100 426 01XX	Mek+Tuş Işıklı Komütatör (Vidalı)	12	120	150,36	184,51	192,81
2100 436 01XX	Mek+Tuş Jalu Anahtarı (Yaysız)(Klipsli)	12	120	140,47	181,42	175,00

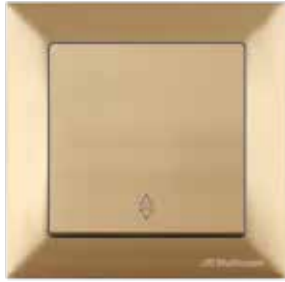

Dimmer Grubu

2100 440 02XX	Mek+Tuş RL Işıklı Dimmer 600W	8	80	345,87	426,93	520,21
2100 444 02XX	Mek+Tuş RL Işıklı Dimmer 1000W	8	80	437,09	676,18	736,16
2100 447 02XX	Mek+Tuş RC Dimmer 325W	8	80	874,49	1.581,19	1.733,33



Elektronik Grubu

2100 450 01XX	Mek+Tuş Energy Saver G.siz Işıklı	8	80	491,10	563,36	603,38
2100 452 01XX	Mek+Tuş Energy Saver Gecikmeli Işıklı	8	80	510,74	583,48	611,70
2100 470 02XX	Mek+Tuş Müzik Yayın Anahtarı	8	80	683,91	717,54	757,09
2100 480 01XX	Mek+Tuş Hoparlör Prizi	8	80	156,98	245,36	267,36
2100 485 02XX	Mek+Tuş Uyarı Zili	8	80	861,37	921,73	945,19
2100 495 02XX	Mek+Tuş Hareket Sensörü	8	80	1.081,61	1.261,09	1.399,19

Priz Grubu

2100 600 02XX	Mek+Tuş Topraklı Priz	12	120	82,06	108,90	121,89
2100 601 02XX	Mek+Tuş Topraksız Priz	12	120	65,95	103,36	114,05
2100 605 02XX	Mek+Tuş Topraklı Priz (Çocuk Kor.)	12	120	91,64	142,44	158,78
2100 606 02XX	Mek+Tuş Topraksız Priz (Çocuk Kor.)	12	120	76,04	123,45	135,44
2100 610 02XX	Mek+Tuş Kapaklı Topraklı Priz	12	120	93,03	119,26	132,14
2100 611 02XX	Mek+Tuş Kapaklı Topraklı Priz (Çoc. Kor.)	12	120	104,11	139,46	159,19
2100 615 02XX	Mek+Tuş Ups (Fransız) Prizi	12	120	97,42	172,91	187,72
2100 616 02XX	Mek+Tuş Ups (Fransız) Prizi (Çoc. Kor.)	12	120	117,17	173,88	188,68
2100 617 02XX	Mek+Tuş Ups Kapaklı (Fransız) Priz	12	120	105,81	163,01	181,67
2100 618 02XX	Mek+Tuş Ups Kapaklı (Fr.) Priz (Çoc. Kor.)	12	120	118,76	168,43	187,42
2100 200 02XX	Mek+Tuş İkili Topraklı Priz Porselen	5	50	154,71	186,92	229,51
2100 201 02XX	Mek+Tuş İkili Topraksız Priz Porselen	5	50	118,18	152,36	183,86
2100 202 02XX	Mek+Tuş İkili Topraklı Priz	5	50	142,93	186,92	227,68
2100 203 02XX	Mek+Tuş İkili Topraksız Priz	5	50	114,22	147,33	184,04
2100 215 01XX	Mek+Tuş İkili Ups Priz	5	50	123,48	142,53	171,98
2100 448 01XX	Mek+Tuş Tekli Usb Şarj Prizi	5	50	322,78	391,55	429,05
2100 449 01XX	Mek+Tuş İkili Usb Şarj Prizi	5	50	409,71	448,72	538,67



Candelä

Mekanizma + Tuş Ürün Listesi

Kod	Ürün Tanımı	Kutu Adedi	Koli Adedi	Beyaz/Krem Fiyat	Metalik Fiyat	Ahşap Fiyat
-----	-------------	------------	------------	------------------	---------------	-------------

İletişim Grubu



2100 125 01XX	Mek+Tuş Telefon Prizi 1Xrj12 (Cat3)	12	120	94,68	115,36	129,40
2100 126 01XX	Mek+Tuş Telefon Prizi 2Xrj12 (Cat3)	12	120	141,61	157,40	181,65
2100 128 01XX	Mek+Tuş Etiketli Tlf Data Priz (Kon.süz)	12	120	71,98	89,00	105,20
2100 135 01XX	Mek+Tuş Data Prizi 1*Rj45 (Kon.süz)	12	120	51,41	70,25	84,63
2100 136 01XX	Mek+Tuş Data Prizi 1*Rj45 (Cat5e)	12	120	140,10	215,64	239,16
2100 137 01XX	Mek+Tuş Data Prizi 2*Rj45 (Kon.süz)	12	120	55,91	68,84	83,56
2100 138 01XX	Mek+Tuş Data Prizi 2*Rj45 (Cat5e)	12	120	224,05	332,72	362,85
2100 139 01XX	Mek+Tuş Tlf Data Priz (Rj12 Cat3 + Cat5e)	12	120	190,97	302,16	330,64
2100 140 01XX	Mek+Tuş Data Prizi 1*Rj45 (Cat6)	12	120	172,57	241,28	261,11
2100 141 01XX	Mek+Tuş Data Prizi 2*Rj45 (Cat6)	12	120	310,39	380,78	416,00
2100 455 01XX	Mek+Tuş Data Prizi 1*Usb	12	120	238,66	259,05	275,35
2100 456 01XX	Mek+Tuş Data Prizi 2*Usb	12	120	416,97	449,29	467,50
2100 457 01XX	Mek+Tuş Data Prizi 1*Hdmi	12	120	325,94	335,38	369,00
2100 458 01XX	Mek+Tuş Data Prizi 2*Hdmi	12	120	584,19	612,59	638,10
2100 459 01XX	Mek+Tuş Data Prizi 1*Usb/1*Hdmi	12	120	502,18	514,94	550,61
2100 460 01XX	Mek+Tuş VGA Priz	12	120	508,23	665,08	709,08
2100 121 02XX	Mek+Tuş Kör Kapak	12	120	45,32	95,82	103,53

TV / SAT Grubu



2100 156 02XX	Mek+Tuş Tv-Sat Prizi (Geçişli) 4DB/F Kon.	12	120	353,42	453,99	558,29
2100 157 02XX	Mek+Tuş Tv-Sat Prizi (Sonlu)	12	120	354,00	454,40	531,57
2100 166 01XX	Mek+Tuş Sat Prizi (Geçişli) 4DB/F Kon.	12	120	187,40	274,84	319,21
2100 167 01XX	Mek+Tuş Sat Prizi (Sonlu)	12	120	187,40	274,84	319,21
2100 170 01XX	Mek+Tuş Tv Prizi (Geçişli) 11DB	12	120	153,11	202,53	219,67
2100 171 01XX	Mek+Tuş Tv Prizi (Sonlu)	12	120	153,59	202,95	220,71
2100 172 01XX	Mek+Tuş Tv Prizi F Dişi	12	120	81,59	84,60	95,32

Çerçeveseler



2125 800 11XX	Tekli Çerçeve	20	400	8,90	22,81	30,87
2125 800 12XX	İkili Yatay Çerçeve	10	200	39,30	54,11	59,72
2125 800 13XX	Üçlü Yatay Çerçeve	10	50	49,48	78,30	113,94
2125 800 14XX	Dörtlü Yatay Çerçeve	10	50	84,30	123,42	131,90
2125 800 15XX	Beşli Yatay Çerçeve	10	50	96,80	174,33	190,59
2125 800 16XX	Altılı Yatay Çerçeve	10	50	103,28	192,22	220,04
2125 800 22XX	İkili Dikey Çerçeve	10	50	39,30	54,11	59,72
2125 800 23XX	Üçlü Dikey Çerçeve	10	50	49,48	78,30	113,94
2125 800 24XX	Dörtlü Dikey Çerçeve	10	50	84,30	123,42	131,90
2125 800 25XX	Beşli Dikey Çerçeve	10	50	96,80	174,33	190,59
2125 800 26XX	Altılı Dikey Çerçeve	10	50	103,28	192,22	220,04
2125 820 12XX	İkili Priz Çerçeve	12	60	25,76	39,28	61,61
2100 000 11XX	Sıva Üstü Kasa	12	60	36,87	81,84	111,65
2200 000 0001	IP44 Kapaklı Priz Conta (Resmi Sayfa 30'da)	24	120	15,47	-	-

İngiliz Tip



2190 500 0201	İngiliz Tipi Anahtarlı Priz Beyaz	12	120	120,60		174,51
---------------	-----------------------------------	----	-----	--------	--	--------

Candelä





SPEAKHONE

RCA

3,5 SES JAKI

XLR ERKEK

XLR DIŞI

USB PRINTER

RİTA MODÜLER SİSTEM

Kod	Ürün Tanımı	Kutu Adedi	Fiyat
2200 250 01XX	Mek+Tuş Speakhone Prizi	1	MÜŞTERİ TEMSİLCİSİNE FİYAT SORUNUZ
2200 251 01XX	Mek+Tuş RCA Prizi	1	
2200 252 01XX	Mek+Tuş 3,5 Ses Jaki	1	
2200 253 01XX	Mek+Tuş XLR Erkek Prizi	1	
2200 254 01XX	Mek+Tuş XLR Dişi Prizi	1	
2200 255 01XX	Mek+Tuş Usb Printer Prizi	1	

ENERGY SAVER ÜRÜN LİSTESİ

Kod	Ürün Tanımı	Kutu Adedi	Fiyat
2100 852 0000	İki Röleli(30A+16A)Energy Saver Röle Ünitesi(VRF/FC) -Kutulu, Panoda 4 modül yer kaplar, 1 klima odalar içindir	1	MÜŞTERİ TEMSİLCİSİNE FİYAT SORUNUZ
2100 853 0000	Üç Röleli(30A+2x16A)Energy Saver Röle Ünitesi(VRF/FC) -Kutulu, Panoda 6 modül yer kaplar, 2 klima odalar içindir	1	
2100 854 0000	İki Röleli(30A+16A)Energy Saver DND Röle Ünitesi(VRF/FC) (DND/MUR kontrolü için ünite olarak vavien komütatör kullanılması şarttır) -Kutulu, Panoda 6 modül yer kaplar, 1 klima odalar içindir	1	
2100 855 0000	Üç Röleli(30A+16A)Energy Saver DND Röle Ünitesi(VRF/FC) (DND/MUR kontrolü için ünite olarak vavien komütatör kullanılması şarttır) -Kutulu, Panoda 6 modül yer kaplar, 1 klima odalar içindir	1	
2110 052 0001	Energy Saver Kapak	1	
2100 012 01XX	Mek+Tuş Impuls Anahtar	12	
2100 023 01XX	Mek+Tuş Impuls Komütatör	12	
2100 024 01XX	Mek+Tuş Impuls Işıklı Anahtar (220V)	12	
2100 027 01XX	Mek+Tuş Impuls Işıklı Komütatör	12	
2125 010 0101	Otel Uyarı İç Ünitesi Komütatörü (Mekanik) Işıklı	12	
2220 010 0101	Rita Otel Uyarı İç Ünitesi Komütatörü (Mekanik) Işıklı	12	
2220 010 0201	Rita Otel Uyarı İç Ünitesi Komütatörü (Mekanik) Işıklı Vidalı	12	
2200 412 01XX	Rita Mek Tuş Impuls Anahtar (Klipsli)	12	
2200 412 02XX	Rita Mek Tuş Impuls Anahtar (Vidalı)	12	
2200 423 01XX	Rita Mek Tuş Impuls Komütatör (Klipsli)	12	
2200 423 02XX	Rita Mek Tuş Impuls Komütatör (Vidalı)	12	
2200 424 01XX	Rita Mek Tuş Impuls Işıklı Anahtar(Klipsli)	12	
2200 424 02XX	Rita Mek Tuş Impuls Işıklı Anahtar (Vidalı)	12	
2200 427 01XX	Rita Mek Tuş Impuls Işıklı Komütatör (Klipsli)	12	
2200 427 02XX	Rita Mek Tuş Impuls Işıklı Komütatör (Vidalı)	12	

BRON

Sıva üstü uygulamalarda
sorunsuz işlevsel çözümler...



Sıva Üstü Anahtar Priz Serisi
Beyaz / Krem Ürün Listesi
BRON Natural

Beyaz
 Krem
 01 02

Kod	Ürün Tanımı	Kutu Adedi	Koli Adedi	Fiyat
2160 301 02XX	Bron S/Ü Anahtar	12	120	81,56
2160 302 02XX	Bron S/Ü Komütatör	12	120	100,43
2160 303 02XX	Bron S/Ü Vavien	12	120	101,63
2160 307 02XX	Bron S/Ü Light (Çağırma)	12	120	84,65
2160 315 02XX	Bron S/Ü Işıklı Anahtar (220V)	12	120	131,78
2160 316 02XX	Bron S/Ü Işıklı Vavien (220V)	12	120	144,40
2160 317 02XX	Bron S/Ü Işıklı Light (Çağırma) (220V)	12	120	134,74
2160 326 02XX	Bron S/Ü Işıklı Komütatör	12	120	132,23
2160 100 02XX	Bron S/Ü Topraklı Priz	12	120	104,45
2160 101 02XX	Bron S/Ü Topraksız Priz	12	120	98,57
2160 103 02XX	Bron S/Ü Topraklı Priz Porselen	12	120	123,23
2160 104 02XX	Bron S/Ü Topraksız Priz Porselen	12	120	97,10
2160 110 02XX	Bron S/Ü Kapaklı Topraklı Priz	10	100	116,08
2160 113 02XX	Bron S/Ü Kapaklı Topraklı Priz Porselen	10	100	134,61
2160 115 02XX	Bron S/Ü Ups (Fransız) Priz	12	120	102,61
2160 125 02XX	Bron S/Ü Telefon Prizi 1 *Rj12 Cat3	12	120	94,93
2160 136 02XX	Bron S/Ü Data Prizi 1 *Rj45 (Cat5)	12	120	110,55
2160 140 02XX	Bron S/Ü Data Prizi 1 *Rj45 (Cat6)	12	120	128,31
2160 166 02XX	Bron S/Ü Sat Prizi (Geçişli) 4Db/F Konnektör	12	120	249,41
2160 167 02XX	Bron S/Ü Sat Prizi (Sonlu)	12	120	216,23
2160 170 02XX	Bron S/Ü Tv Prizi (Geçişli)	12	120	210,97
2160 171 02XX	Bron S/Ü Tv Prizi (Sonlu)	12	120	211,62
2160 200 02XX	Bron S/Ü İkili Topraklı Priz Porselen	6	60	172,60
2160 201 02XX	Bron İkili Topraksız Priz Porselen	6	60	137,71
2160 202 02XX	Bron S/Ü İkili Topraklı Priz	6	60	158,14
2160 203 02XX	Bron S/Ü İkili Topraksız Priz	6	60	126,68
2160 215 02XX	Bron S/Ü İkili Ups (Fransız) Priz	6	60	130,97

Sıva Üstü Anahtar Priz Serisi
Meşe / Ceviz Ürün Listesi
BRON Ahşap

Meşe
 Ceviz
 58 57

Kod	Ürün Tanımı	Kutu Adedi	Koli Adedi	Fiyat
2160 301 02XX	Bron S/Ü Anahtar	12	120	110,47
2160 302 02XX	Bron S/Ü Komütatör	12	120	128,24
2160 303 02XX	Bron S/Ü Vavien	12	120	131,38
2160 307 02XX	Bron S/Ü Light (Çağırma)	12	120	113,96
2160 315 02XX	Bron S/Ü Işıklı Anahtar (220V)	12	120	148,77
2160 316 02XX	Bron S/Ü Işıklı Vavien (220V)	12	120	161,47
2160 317 02XX	Bron S/Ü Işıklı Light (Çağırma) (220V)	12	120	151,61
2160 326 02XX	Bron S/Ü Işıklı Komütatör	12	120	164,38
2160 100 02XX	Bron S/Ü Topraklı Priz	12	120	156,90
2160 101 02XX	Bron S/Ü Topraksız Priz	12	120	119,81
2160 103 02XX	Bron S/Ü Topraklı Priz Porselen	12	120	148,14
2160 104 02XX	Bron S/Ü Topraksız Priz Porselen	12	120	123,24
2160 110 02XX	Bron S/Ü Kapaklı Topraklı Priz	10	100	152,20
2160 113 02XX	Bron S/Ü Kapaklı Topraklı Priz Porselen	10	100	170,74
2160 115 02XX	Bron S/Ü Ups (Fransız) Priz	12	120	128,78
2160 125 02XX	Bron S/Ü Telefon Prizi 1 *Rj12 Cat3	12	120	137,90
2160 136 02XX	Bron S/Ü Data Prizi 1 *Rj45 (Cat5)	12	120	195,25
2160 140 02XX	Bron S/Ü Data Prizi 1 *Rj45 (Cat6)	12	120	209,97
2160 166 02XX	Bron S/Ü Sat Prizi (Geçişli) 4Db/F Konnektör	12	120	279,54
2160 167 02XX	Bron S/Ü Sat Prizi (Sonlu)	12	120	253,87
2160 170 02XX	Bron S/Ü Tv Prizi (Geçişli)	12	120	234,85
2160 171 02XX	Bron S/Ü Tv Prizi (Sonlu)	12	120	234,46
2160 200 02XX	Bron S/Ü İkili Topraklı Priz Porselen	6	60	266,51
2160 201 02XX	Bron İkili Topraksız Priz Porselen	6	60	198,26
2160 202 02XX	Bron S/Ü İkili Topraklı Priz	6	60	263,80
2160 203 02XX	Bron S/Ü İkili Topraksız Priz	6	60	195,69
2160 215 02XX	Bron S/Ü İkili Ups (Fransız) Priz	6	60	302,07

Nemliyer

Güvenliđi artırılmıř,
sıva üstü anahtar serisi...

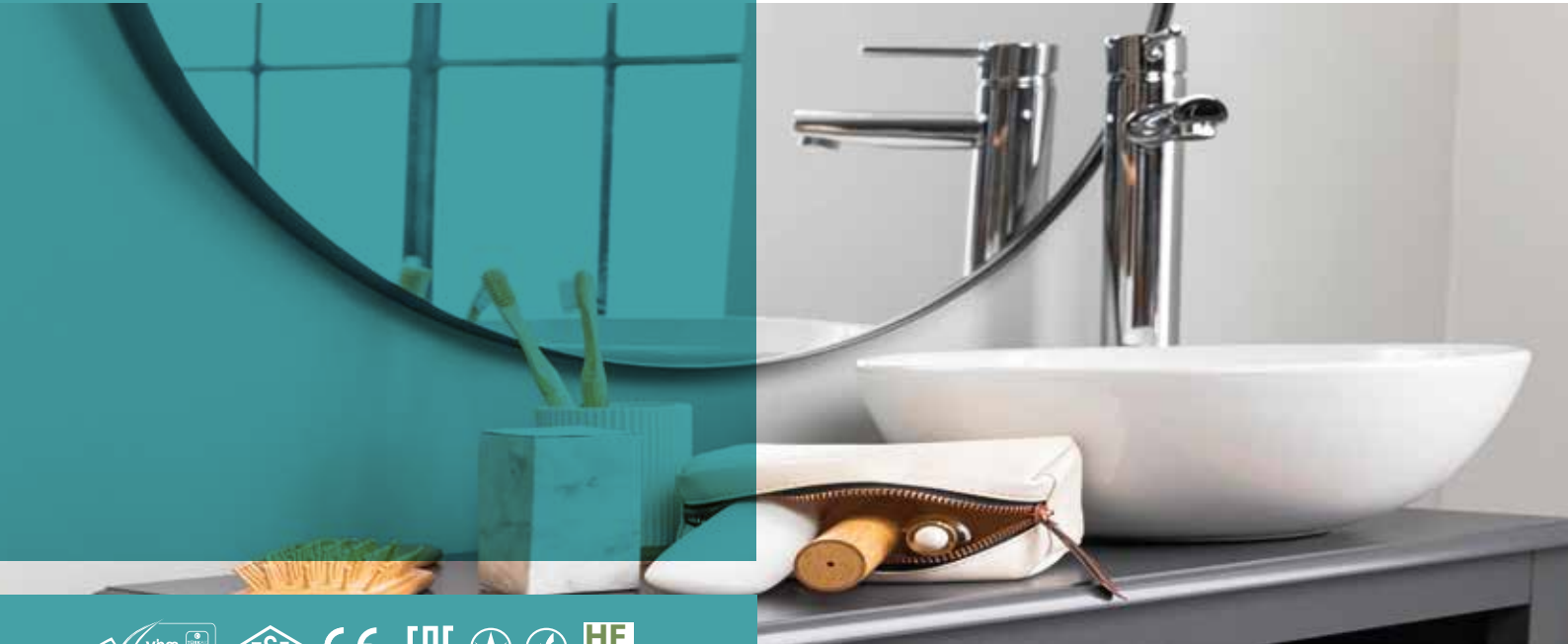

Nemliyer Natural

Beyaz / Gri Ürün Listesi

Kod	Ürün Tanımı	Kutu Adedi	Koli Adedi	Fiyat
2150 301 02XX	Anahtar Nemliyer	10	100	110,66
2150 302 02XX	Komütatör Nemliyer	10	100	135,54
2150 303 02XX	Vavien (İki Yollu Anahtar) Nemliyer	10	100	130,74
2150 305 02XX	Çift Kutuplu Anahtar Nemliyer	10	100	142,68
2150 307 02XX	Çağırma Nemliyer	10	100	113,76
2150 110 02XX	Kapaklı Topraklı Priz Nemliyer	8	80	142,67
2150 115 02XX	Ups Kapaklı Topraklı Priz Nemliyer	8	80	152,27
2150 125 02XX	Telefon Prizi 1*Rj12 Nemliyer	10	100	125,15
2150 136 01XX	Data Prizi 1*Rj45 (Cat5e) Nemliyer	10	100	137,99
2150 166 02XX	Sat Prizi (Geçişli) Nemliyer	10	100	214,08
2150 167 02XX	Sat Prizi (Sonlu) Nemliyer	10	100	214,08
2150 170 02XX	Tv Prizi (Geçişli) Nemliyer	10	100	203,45
2150 171 02XX	Tv Prizi (Sonlu) Nemliyer	10	100	192,87



Beyaz-01



Gri-03



Nemliyer Ahşap

Ahşap Ürün Listesi

Kod	Ürün Tanımı	Kutu Adedi	Koli Adedi	Fiyat
2150 301 02XX	Anahtar Nemliyer	10	100	139,39
2150 302 02XX	Komütatör Nemliyer	10	100	160,44
2150 303 02XX	Vavien (İki Yollu Anahtar) Nemliyer	10	100	158,06
2150 305 02XX	Çift Kutuplu Anahtar Nemliyer	10	100	172,47
2150 307 02XX	Çağırma Nemliyer	10	100	146,04
2150 110 02XX	Kapaklı Topraklı Priz Nemliyer	8	80	179,66
2150 115 02XX	Ups Kapaklı Topraklı Priz Nemliyer	8	80	190,10
2150 125 02XX	Telefon Prizi 1*Rj12 Nemliyer	10	100	140,07
2150 136 01XX	Data Prizi 1*Rj45 (Cat5e) Nemliyer	10	100	159,55
2150 166 02XX	Sat Prizi (Geçişli) Nemliyer	10	100	240,14
2150 167 02XX	Sat Prizi (Sonlu) Nemliyer	10	100	240,29
2150 170 02XX	Tv Prizi (Geçişli) Nemliyer	10	100	220,22
2150 171 02XX	Tv Prizi (Sonlu) Nemliyer	10	100	210,57



MUT-40
AÇIK KAYIN



MUT-41
KOYU CEVİZ



MUT-43
MERBAU



MUT-44
MAUN



MUT-49
ARMUT

Fiş Prizler Grup Prizler



Taşınabilir enerji ihtiyacınız için en kullanışlı seçenekler...



Ri-tech Grup Prizler



Kod	Ürün Tanımı	Kutu Adedi	Fiyat
001 175 210001 00 00	İKİLİ TOP.LI GRUP PRİZ(Ç.K.)(KLEMENSLİ)	25	108,48
001 175 210002 01 00	İKİLİ TOP.LI GRUP PRİZ(Ç.K.)(1 MT)	12	197,04
001 175 210002 02 00	İKİLİ TOP.LI GRUP PRİZ(Ç.K.)(2 MT)	12	237,47
001 175 210002 03 00	İKİLİ TOP.LI GRUP PRİZ(Ç.K.)(3 MT)	12	280,34
001 175 210002 05 00	İKİLİ TOP.LI GRUP PRİZ(Ç.K.)(5 MT)	12	341,44
001 175 220001 00 00	İKİLİ ANAHT. TOP.LI GRUP PRİZ(Ç.K.)(KLEMENSLİ)	25	215,48
001 175 220002 01 00	İKİLİ ANAHT. TOP.LI GRUP PRİZ(Ç.K.)(1 MT)	12	305,31
001 175 220002 02 00	İKİLİ ANAHT. TOP.LI GRUP PRİZ(Ç.K.)(2 MT)	12	345,73
001 175 220002 03 00	İKİLİ ANAHT. TOP.LI GRUP PRİZ(Ç.K.)(3 MT)	12	388,61
001 175 220002 05 00	İKİLİ ANAHT. TOP.LI GRUP PRİZ(Ç.K.)(5 MT)	12	475,34
001 175 310001 00 00	ÜÇLÜ TOP.LI GRUP PRİZ(Ç.K.)(KLEMENSLİ)	25	132,10
001 175 310002 01 00	ÜÇLÜ TOP.LI GRUP PRİZ(Ç.K.)(1 MT)	12	214,39
001 175 310002 02 00	ÜÇLÜ TOP.LI GRUP PRİZ(Ç.K.)(2 MT)	12	254,81
001 175 310002 03 00	ÜÇLÜ TOP.LI GRUP PRİZ(Ç.K.)(3 MT)	12	297,73
001 175 310002 05 00	ÜÇLÜ TOP.LI GRUP PRİZ(Ç.K.)(5 MT)	12	384,00
001 175 320001 00 00	ÜÇLÜ ANAHT. TOP.LI GRUP PRİZ(Ç.K.)(KLEMENSLİ)	25	247,83
001 175 320002 01 00	ÜÇLÜ ANAHT. TOP.LI GRUP PRİZ(Ç.K.)(1 MT)	12	338,40
001 175 320002 02 00	ÜÇLÜ ANAHT. TOP.LI GRUP PRİZ(Ç.K.)(2 MT)	12	372,50
001 175 320002 03 00	ÜÇLÜ ANAHT. TOP.LI GRUP PRİZ(Ç.K.)(3 MT)	12	415,73
001 175 320002 05 00	ÜÇLÜ ANAHT. TOP.LI GRUP PRİZ(Ç.K.)(5 MT)	12	501,52
001 175 350001 00 00	ÜÇLÜ USB ANAHT. TOP.LI GRUP PRİZ(Ç.K.)(KLEMENSLİ)	25	494,46
001 175 350002 02 00	ÜÇLÜ USB ANAHT. TOP.LI GRUP PRİZ(Ç.K.)(2 MT)	12	661,21
001 175 350002 03 00	ÜÇLÜ USB ANAHT. TOP.LI GRUP PRİZ(Ç.K.)(3 MT)	12	731,13
001 175 350002 05 00	ÜÇLÜ USB ANAHT. TOP.LI GRUP PRİZ(Ç.K.)(5 MT)	12	852,51
001 175 410001 00 00	DÖRTLÜ TOP.LI GRUP PRİZ(Ç.K.)(KLEMENSLİ)	25	165,79
001 175 410002 01 00	DÖRTLÜ TOP.LI GRUP PRİZ(Ç.K.)(1 MT)	12	252,43
001 175 410002 02 00	DÖRTLÜ TOP.LI GRUP PRİZ(Ç.K.)(2 MT)	12	285,84
001 175 410002 03 00	DÖRTLÜ TOP.LI GRUP PRİZ(Ç.K.)(3 MT)	12	335,67
001 175 410002 05 00	DÖRTLÜ TOP.LI GRUP PRİZ(Ç.K.)(5 MT)	12	418,72
001 175 420001 00 00	DÖRTLÜ ANAHT. TOP.LI GRUP PRİZ(Ç.K.)(KLEMENSLİ)	25	304,35
001 175 420002 01 00	DÖRTLÜ ANAHT. TOP.LI GRUP PRİZ(Ç.K.)(1 MT)	12	379,41
001 175 420002 02 00	DÖRTLÜ ANAHT. TOP.LI GRUP PRİZ(Ç.K.)(2 MT)	12	409,30
001 175 420002 03 00	DÖRTLÜ ANAHT. TOP.LI GRUP PRİZ(Ç.K.)(3 MT)	12	463,71
001 175 420002 05 00	DÖRTLÜ ANAHT. TOP.LI GRUP PRİZ(Ç.K.)(5 MT)	12	538,68
001 175 610001 00 00	ALTILI TOP.LI GRUP PRİZ(Ç.K.)(KLEMENSLİ)	25	226,09
001 175 610002 01 00	ALTILI TOP.LI GRUP PRİZ(Ç.K.)(1 MT)	12	341,44
001 175 610002 02 00	ALTILI TOP.LI GRUP PRİZ(Ç.K.)(2 MT)	12	394,50
001 175 610002 03 00	ALTILI TOP.LI GRUP PRİZ(Ç.K.)(3 MT)	12	464,86
001 175 610002 05 00	ALTILI TOP.LI GRUP PRİZ(Ç.K.)(5 MT)	12	639,92
001 175 620001 00 00	ALTILI ANAHT. TOP.LI GRUP PRİZ(Ç.K.)(KLEMENSLİ)	25	381,92
001 175 620002 01 00	ALTILI ANAHT. TOP.LI GRUP PRİZ(Ç.K.)(1 MT)	12	476,30
001 175 620002 02 00	ALTILI ANAHT. TOP.LI GRUP PRİZ(Ç.K.)(2 MT)	12	506,79
001 175 620002 03 00	ALTILI ANAHT. TOP.LI GRUP PRİZ(Ç.K.)(3 MT)	12	571,47
001 175 620002 05 00	ALTILI ANAHT. TOP.LI GRUP PRİZ(Ç.K.)(5 MT)	12	760,67
001 175 650001 00 00	ALTILI USB ANAHT. TOP.LI GRUP PRİZ(Ç.K.)(KLEMENSLİ)	25	593,37
001 175 650002 02 00	ALTILI USB ANAHT. TOP.LI GRUP PRİZ(Ç.K.)(2 MT)	12	841,42
001 175 650002 03 00	ALTILI USB ANAHT. TOP.LI GRUP PRİZ(Ç.K.)(3 MT)	12	920,63
001 175 650002 05 00	ALTILI USB ANAHT. TOP.LI GRUP PRİZ(Ç.K.)(5 MT)	12	1.099,37

Ri-tech Grup Prizler



ALTI LI ŞOK KORUMALI USB ANAHT. TOPRAKLI GRUP PRİZ



2'Lİ USB ŞARJ ADAPTÖR



TEKLİ ŞOK KORUMALI PRİZ



2'Lİ USB TOPRAKLI PRİZ

Kod	Ürün Tanımı	Kutu Adedi	Fiyat
001 175 330001 00 00	ÜÇLÜ UPS GRUP PRİZ(Ç.K.)(KLEMENSLİ)	25	154,57
001 175 330002 02 00	ÜÇLÜ UPS GRUP PRİZ(Ç.K.)(2 MT)	12	322,98
001 175 330002 03 00	ÜÇLÜ UPS GRUP PRİZ(Ç.K.)(3 MT)	12	377,72
001 175 330002 05 00	ÜÇLÜ UPS GRUP PRİZ(Ç.K.)(5 MT)	12	481,26
001 175 340001 00 00	ÜÇLÜ ANAHT. UPS GRUP PRİZ(Ç.K.)(KLEMENSLİ)	25	273,46
001 175 340002 02 00	ÜÇLÜ ANAHT. UPS GRUP PRİZ(Ç.K.)(2 MT)	12	380,66
001 175 340002 03 00	ÜÇLÜ ANAHT. UPS GRUP PRİZ(Ç.K.)(3 MT)	12	455,09
001 175 340002 05 00	ÜÇLÜ ANAHT. UPS GRUP PRİZ(Ç.K.)(5 MT)	12	553,40
001 175 430001 00 00	DÖRTLÜ UPS GRUP PRİZ(Ç.K.)(KLEMENSLİ)	25	229,55
001 175 430002 02 00	DÖRTLÜ UPS GRUP PRİZ(Ç.K.)(2 MT)	12	412,95
001 175 430002 03 00	DÖRTLÜ UPS GRUP PRİZ(Ç.K.)(3 MT)	12	461,69
001 175 430002 05 00	DÖRTLÜ UPS GRUP PRİZ(Ç.K.)(5 MT)	12	618,97
001 175 440001 00 00	DÖRTLÜ ANAHT. UPS GRUP PRİZ(Ç.K.)(KLEMENSLİ)	25	352,14
001 175 440002 02 00	DÖRTLÜ ANAHT. UPS GRUP PRİZ(Ç.K.)(2 MT)	12	566,75
001 175 440002 03 00	DÖRTLÜ ANAHT. UPS GRUP PRİZ(Ç.K.)(3 MT)	12	607,17
001 175 440002 05 00	DÖRTLÜ ANAHT. UPS GRUP PRİZ(Ç.K.)(5 MT)	12	777,32
001 175 630001 00 00	ALTI LI UPS GRUP PRİZ(Ç.K.)(KLEMENSLİ)	25	314,91
001 175 630002 02 00	ALTI LI UPS GRUP PRİZ(Ç.K.)(2 MT)	12	526,00
001 175 630002 03 00	ALTI LI UPS GRUP PRİZ(Ç.K.)(3 MT)	12	676,76
001 175 630002 05 00	ALTI LI UPS GRUP PRİZ(Ç.K.)(5 MT)	12	921,54
001 175 640001 00 00	ALTI LI ANAHT. UPS GRUP PRİZ(Ç.K.)(KLEMENSLİ)	25	466,85
001 175 640002 02 00	ALTI LI ANAHT. UPS GRUP PRİZ(Ç.K.)(2 MT)	12	668,89
001 175 640002 03 00	ALTI LI ANAHT. UPS GRUP PRİZ(Ç.K.)(3 MT)	12	752,27
001 175 640002 05 00	ALTI LI ANAHT. UPS GRUP PRİZ(Ç.K.)(5 MT)	12	1.044,46

Ri-tech Akım (Şok) Korumalı Grup Priz

Kod	Ürün Tanımı	Kutu Adedi	Fiyat
001 175 660002 15 00	ALTI LI ŞOK.KOR. USB ANAHT. TOP.LI GRUP PRİZ(Ç.K.) (3X1.5 1.5 MT)	12	1.298,07
001 175 670002 15 00	ALTI LI ŞOK.KOR. ANAHT. TOP.LI GRUP PRİZ(Ç.K.) (3X1.5 1.5 MT)	12	1.026,24

Ri-tech USB Şarj

Kod	Ürün Tanımı	Kutu Adedi	Fiyat
001 888 100002 00 00	2'Li USB ŞARJ ADAPTÖR 2,4A	20	245,04
001 888 100004 00 00	TEKLİ ŞOK KORUMALI PRİZ	12	389,81

Kod	Ürün Tanımı	Kutu Adedi	Koli Adedi	Beyaz/Krem Fiyat	Metalik Fiyat	Ahşap Fiyat
2220 619 02XX	İKİLİ USB TOPRAKLI PRİZ (ÇERÇEVE DAHİL)	8	80	495,47	865,82	913,07



Kod	Ürün Tanımı	Kutu Adedi	Fiyat
001 171 290001 00 00	İkili Topraksız Grup Priz (Klemensli) Olimpia	25	71,98
001 171 290002 02 00	İkili Topraksız Grup Priz (2Mt) Olimpia	12	164,34
001 171 290002 03 00	İkili Topraksız Grup Priz (3Mt) Olimpia	12	191,31
001 171 290002 05 00	İkili Topraksız Grup Priz (5Mt) Olimpia	12	239,80
001 171 210001 00 00	İkili Topraklı Grup Priz (Klemensli) Olimpia	25	103,05
001 171 210002 02 00	İkili Topraklı Grup Priz (2Mt) Olimpia	12	225,59
001 171 210002 03 00	İkili Topraklı Grup Priz (3M) Olimpia	12	266,33
001 171 210002 05 00	İkili Topraklı Grup Priz (5M) Olimpia	12	331,19
001 171 390001 00 00	Üçlü Topraksız Grup Priz (Klemensli) Olimpia	25	102,06
001 171 390002 02 00	Üçlü Topraksız Grup Priz (2Mt) Olimpia	12	191,52
001 171 390002 03 00	Üçlü Topraksız Grup Priz(3Mt) Olimpia	12	218,55
001 171 390002 05 00	Üçlü Topraksız Grup Priz (5Mt) Olimpia	12	271,86
001 171 310001 00 00	Üçlü Grup Priz Topraklı (Klemensli) Olimpia	25	125,50
001 171 310002 02 00	Üçlü Topraklı Grup Priz (2Mt) Olimpia	12	247,17
001 171 310002 03 00	Üçlü Topraklı Grup Priz (3Mt) Olimpia	12	288,80
001 171 310002 05 00	Üçlü Topraklı Grup Priz (5Mt) Olimpia	12	372,48
001 171 320001 00 00	Üçlü Topraklı Grup Priz (Klemensli Anahtarlı) Olimpia	25	235,44
001 171 320002 02 00	Üçlü Topraklı Grup Priz (Anahtarlı 2 Mt) Olimpia	12	353,87
001 171 320002 03 00	Üçlü Topraklı Grup Priz (Anahtarlı 3 Mt) Olimpia	12	394,94
001 171 320002 05 00	Üçlü Topraklı Grup Priz (Anahtarlı 5 Mt) Olimpia	12	476,45
001 171 340001 00 00	Üçlü Ups Grup Priz (Klemensli) Olimpia	25	259,79
001 171 330001 02 00	Üçlü Ups Grup Priz (2Mt) Olimpia	12	306,83
001 171 330001 03 00	Üçlü Ups Grup Priz (3Mt) Olimpia	12	358,84
001 171 330001 05 00	Üçlü Ups Grup Priz (5Mt) Olimpia	12	457,20
001 171 410001 00 00	Dörtlü Topraklı Grup Priz (Klemensli) Olimpia	25	157,50
001 171 410001 02 00	Dörtlü Topraklı Grup Priz (2Mt) Olimpia	12	271,55
001 171 410001 03 00	Dörtlü Topraklı Grup Priz (3Mt) Olimpia	12	318,89
001 171 410001 05 00	Dörtlü Topraklı Grup Priz (5Mt) Olimpia	12	397,78
001 171 410002 00 00	Dörtlü Topraklı Grup Priz (Klemensli-Anah. Olimpia)	25	289,13
001 171 410002 02 00	Dörtlü Topraklı Grup Priz (Anahtarlı 2 Mt) Olimpia	12	388,83
001 171 410002 03 00	Dörtlü Topraklı Grup Priz (Anahtarlı 3 Mt) Olimpia	12	440,52
001 171 410002 05 00	Dörtlü Topraklı Grup Priz (Anahtarlı 5 Mt) Olimpia	12	511,75
001 171 610001 00 00	Altılı Grup Priz Top.lı (Klemensli) Olimpia	25	214,78
001 171 610001 02 00	Altılı Topraklı Grup Priz (2 Mt) Olimpia	12	374,77
001 171 610001 03 00	Altılı Topraklı Grup Priz (3 Mt) Olimpia	12	441,62
001 171 610001 05 00	Altılı Topraklı Grup Priz (5 Mt) Olimpia	12	620,72
001 171 610002 00 00	Altılı Topraklı Grup Priz (Klemensli-Anahtarlı) Olimpia	25	362,82
001 171 610002 02 00	Altılı Topraklı Grup Priz (Anahtarlı 2 Mt) Olimpia	12	481,46
001 171 610002 03 00	Altılı Topraklı Grup Priz (Anahtarlı 3 Mt) Olimpia	12	542,89
001 171 610002 05 00	Altılı Topraklı Grup Priz (Anahtarlı 5 Mt) Olimpia	12	722,64
001 170 110001 00 00	10'lu Topraklı Grup Priz (Klemensli)	20	532,57



Fiş Prizler

Ürün Listesi



Ürün Kodu	001 170 012001 00 00
Ürün Adı	Topraklı Erkek Fiş (Kuyruklu)
Kutu Adedi	50
Fiyatı	50,19 ₺

CE



Ürün Kodu	001 170 010001 00 00
Ürün Adı	Erkek Fiş
Kutu Adedi	50
Fiyatı	35,51 ₺

CE



Ürün Kodu	001 170 013001 00 00
Ürün Adı	Topraklı Erkek Fiş Ups (Kuyruklu)
Kutu Adedi	50
Fiyatı	48,65 ₺

CE



Ürün Kodu	001 170 020001 00 00
Ürün Adı	Dişi Fiş
Kutu Adedi	50
Fiyatı	25,66 ₺

CE



Ürün Kodu	001 170 011001 00 00
Ürün Adı	Topraklı Erkek Fiş
Kutu Adedi	50
Fiyatı	48,58 ₺

CE



Ürün Kodu	001 170 021001 00 00
Ürün Adı	Topraklı Dişi Fiş
Kutu Adedi	25
Fiyatı	48,20 ₺

CE



Ürün Kodu	001 170 014001 00 00
Ürün Adı	Topraklı Erkek Fiş Ups
Kutu Adedi	50
Fiyatı	49,11 ₺

CE



Ürün Kodu	001 170 011002 00 00
Ürün Adı	Kulplu Topraklı Erkek Fiş
Kutu Adedi	50
Fiyatı	50,95 ₺

CE



Ürün Kodu	001 170 051001 00 00
Ürün Adı	Topraklı Erkek Fiş
Kutu Adedi	50/600
Fiyatı	49,40 ₺

CE



Ürün Kodu	001 170 061001 00 00
Ürün Adı	Topraklı Dişi Fiş
Kutu Adedi	25/600
Fiyatı	55,58 ₺

CE



Ürün Kodu	001 170 050001 00 00
Ürün Adı	Erkek Fiş
Kutu Adedi	50/600
Fiyatı	33,98 ₺

CE



Ürün Kodu	001 170 060001 00 00
Ürün Adı	Dişi Fiş
Kutu Adedi	50/600
Fiyatı	24,70 ₺

CE

Fiş Prizler

Ürün Listesi



CE

Ürün Kodu	001 170 033001 00 00
Ürün Adı	Topraklı Üçlü Fiş-Priz (Yonca Tip) (S/A)
Kutu Adedi	12/144
Fiyatı	194,54 ₺



Ürün Kodu	001 888 000001 00 00
Ürün Adı	Prizmatik Çocuk Koruma Kapağı
Kutu Adedi	100
Fiyatı	26,50 ₺



CE

Ürün Kodu	001 170 033002 00 00
Ürün Adı	Topraklı Üçlü Fiş-Priz (Yonca Tip) (S/Ü)
Kutu Adedi	20/240
Fiyatı	189,91 ₺



CE

Ürün Kodu	001 170 033003 00 00
Ürün Adı	İkili Topraklı Fiş-Priz (Düz Tip)
Kutu Adedi	24
Fiyatı	183,74 ₺



Ürün Kodu	001 170 030002 00 00
Ürün Adı	Adaptör Fiş, Priz (İngiliz Tip)
Kutu Adedi	50/500
Fiyatı	2,58 \$



CE

Ürün Kodu	001 170 033005 00 00
Ürün Adı	Üçlü Topraklı Fiş-Priz (Düz Tip)
Kutu Adedi	24
Fiyatı	222,34 ₺



CE

Ürün Kodu	001 170 030001 00 00
Ürün Adı	Arapar Anahtar
Kutu Adedi	50/600
Fiyatı	26,35 ₺



CE

Ürün Kodu	001 170 033004 00 00
Ürün Adı	Üçlü Topraklı Fiş-Priz (Düz Tip Anahtarlı)
Kutu Adedi	24
Fiyatı	304,17 ₺

Çocuk Korumasız
Prizlerinizin
Çözümü



IP44
Kapaklı Priz Conta ile
Daha Güvende..

Fiş Prizler

Ürün Listesi



CE

Ürün Kodu	001 170 011002 00 11
Ürün Adı	Kulplu Topraklı Erkek Fiş Siyah
Kutu Adedi	50
Fiyatı	50,95 ₺



CE

Ürün Kodu	001 170 050001 00 11
Ürün Adı	Erkek Fiş Siyah
Kutu Adedi	50
Fiyatı	33,98 ₺



CE

Ürün Kodu	001 170 051001 00 11
Ürün Adı	Topraklı Erkek Fiş Siyah
Kutu Adedi	50
Fiyatı	49,40 ₺



CE

Ürün Kodu	001 170 060001 00 11
Ürün Adı	Dişi Fiş Siyah
Kutu Adedi	50
Fiyatı	24,70 ₺



CE

Ürün Kodu	001 170 061001 00 11
Ürün Adı	Topraklı Dişi Fiş Siyah
Kutu Adedi	25
Fiyatı	55,58 ₺



CE

Ürün Kodu	001 170 030001 00 11
Ürün Adı	Arapar Anahtar Siyah
Kutu Adedi	50
Fiyatı	26,35 ₺



CE

Ürün Kodu	001 170 033002 00 11
Ürün Adı	Topraklı Üçlü Fiş-Priz (Yonca Tip) Siyah
Kutu Adedi	20
Fiyatı	189,91 ₺



CE

Ürün Kodu	001 170 033003 00 11
Ürün Adı	İkili Topraklı Fiş-Priz Düz Tip Siyah
Kutu Adedi	24
Fiyatı	183,74 ₺



CE

Ürün Kodu	001 170 033005 00 11
Ürün Adı	Üçlü Topraklı Fiş-Priz (Düz Tip) Siyah
Kutu Adedi	24
Fiyatı	222,34 ₺



CE

Ürün Kodu	001 170 033004 00 11
Ürün Adı	Üçlü Topraklı Anahtarlı Fiş-Priz (Düz Tip) Siyah
Kutu Adedi	24
Fiyatı	304,17 ₺



CE

Ürün Kodu	001 170 030002 00 11
Ürün Adı	Adaptör Fiş, Priz (İngiliz Tip) Siyah
Kutu Adedi	50
Fiyatı	2,58 \$

KABLO KANALLARI, PLASTİK,
TESİSAT ve
AYDINLATMA GRUBU

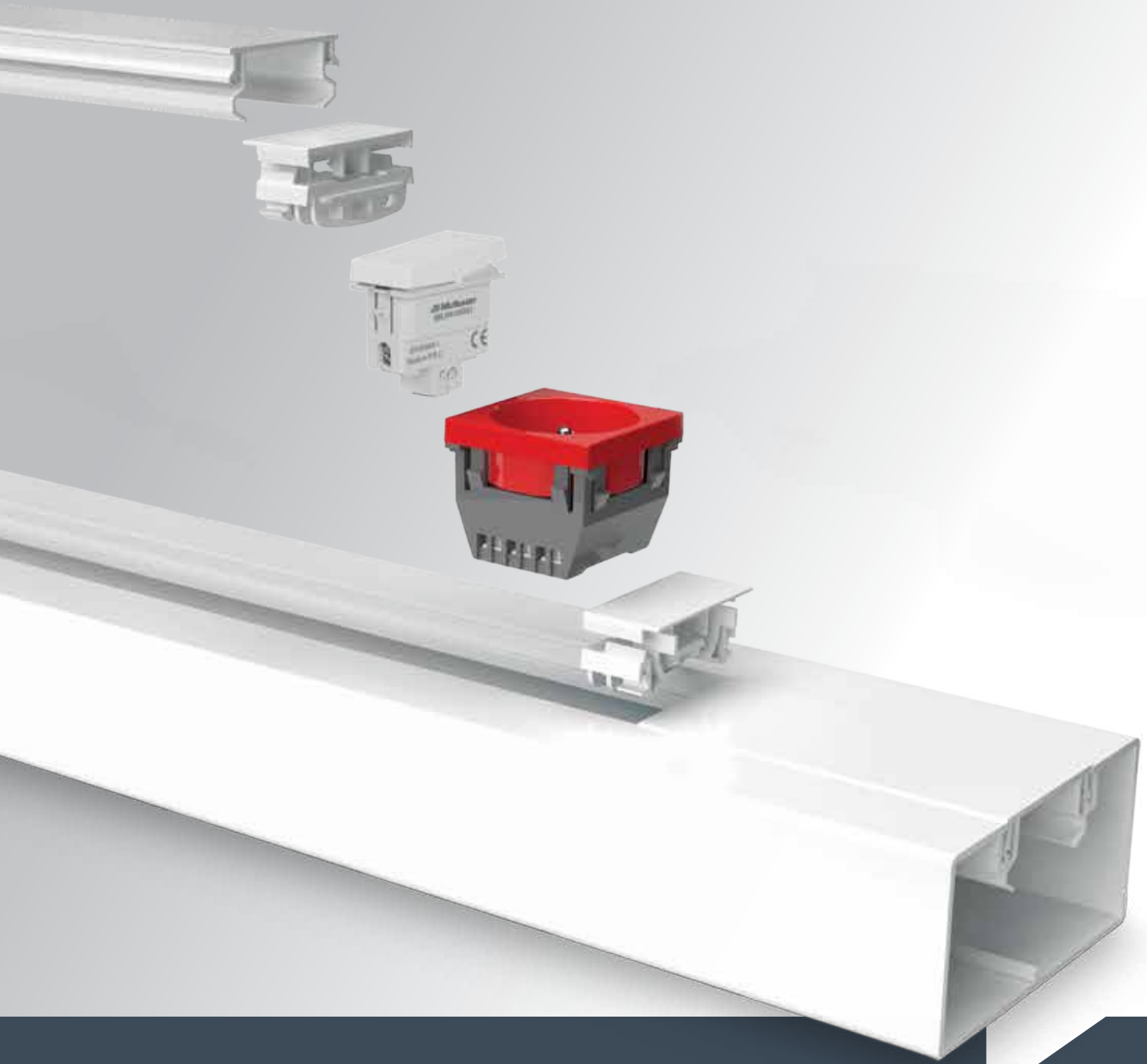

UÇ TAPA



T KÖŞE



İÇ KÖŞE



EK PARÇA



DIŞ KÖŞE



L KÖŞE

KABLO KANALLARI ve AKSESUARLARI

YENİ PRİZ MONTAJ SETLERİMİZ YENİ TIRNAK YAPISI İLE DAHA SAĞLAM DAHA GÜVENLİ

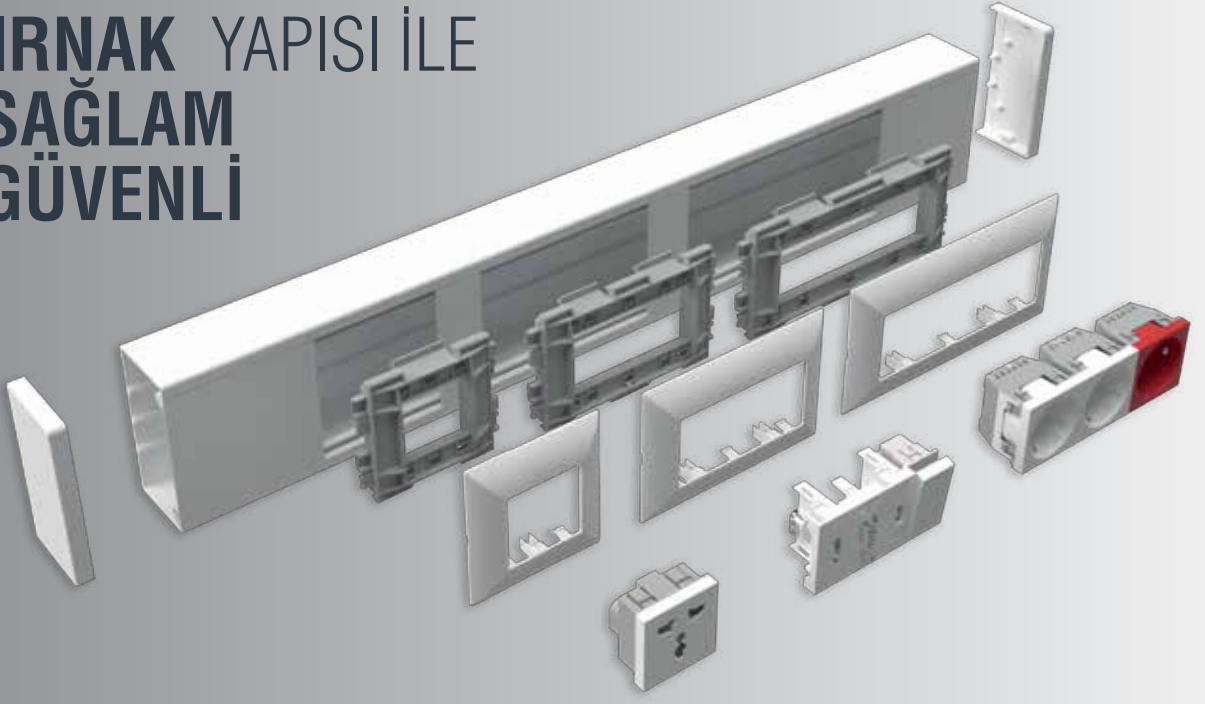

“Ofisinizde, evinizde düzensiz kablo karmaşasını düzenlemek için her zaman iyi bir seçimdir.”

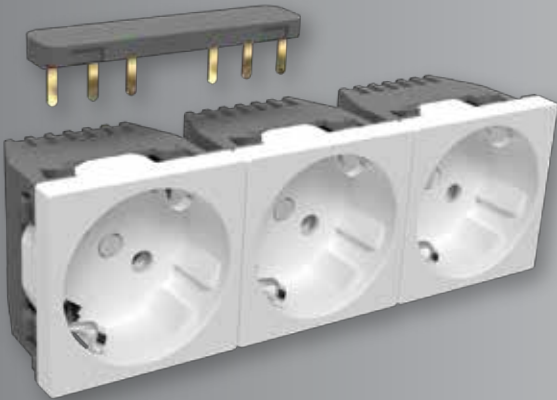

YENİ

LED
İÇİN ÖZEL
13x12,5mm

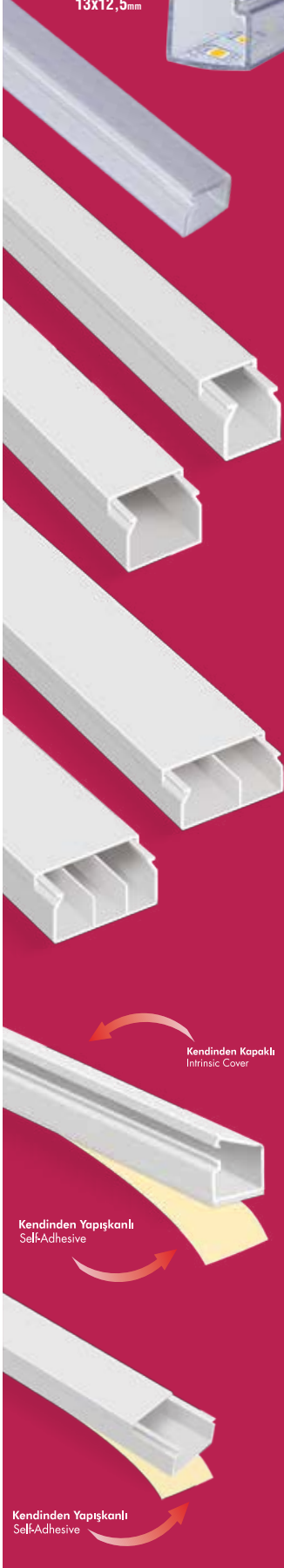

Kendinden Kapaklı
Intrinsic Cover

Kendinden Yapışkanlı
Self-Adhesive

Kendinden Yapışkanlı
Self-Adhesive

Ürün Kodu	Ürün Adı	Amb. (Kutu)	Amb. Birimi	Fiyat (₺)
LED İÇİN KENDİNDEN KAPAKLI KABLO KANALI				
001 004 013012 20 44	13x12,5 MM KABLO KANALI ŞEFFAF KANAL (LED İÇİN)	300	mt.	30,72
CANALEX SERİSİ TSE'Lİ KAPALI TİP KABLO KANALLARI (KUTULU)				
001 156 012012 20 00	12x12 MM KABLO KANALI (CANALEX)	250	mt.	9,17
001 156 015010 20 00	15x10 MM KABLO KANALI (CANALEX)	250	mt.	9,69
001 156 016016 20 00	16x16 MM KABLO KANALI (CANALEX)	250	mt.	10,71
001 156 020010 20 00	20x10 MM KABLO KANALI (CANALEX)	200	mt.	11,15
001 156 020015 20 00	20x15 MM KABLO KANALI (CANALEX)	200	mt.	16,12
001 156 025016 20 00	25x16 MM KABLO KANALI (CANALEX)	150	mt.	16,37
001 156 025025 20 00	25x25 MM KABLO KANALI (CANALEX)	100	mt.	22,15
001 156 040016 20 00	40x16 MM KABLO KANALI (CANALEX)	100	mt.	27,59
001 156 040025 20 00	40x25 MM KABLO KANALI (CANALEX)	80	mt.	30,28
001 156 040040 20 00	40x40 MM KABLO KANALI (CANALEX)	50	mt.	38,61
001 156 060040 20 00	60x40 MM KABLO KANALI (CANALEX)	40	mt.	55,81
001 156 060060 20 00	60x60 MM KABLO KANALI (CANALEX)	32	mt.	86,8
001 156 080040 20 00	80x40 MM KABLO KANALI (CANALEX)	30	mt.	88,08
001 156 080060 20 00	80x60 MM KABLO KANALI (CANALEX)	24	mt.	103,38
001 156 100040 20 00	100x40 MM KABLO KANALI (CANALEX)	24	mt.	107,45
001 156 100060 20 00	100x60 MM KABLO KANALI (CANALEX)	20	mt.	149,03
CANALEX SERİSİ KAPALI TİP KABLO KANALLARI (YAPIŞKAN BANTLI)				
001 157 012012 20 00	12x12 MM KABLO KANALI CANALEX (YAPIŞKAN BANTLI)	250	mt.	10,85
001 157 015010 20 00	15x10 MM KABLO KANALI CANALEX (YAPIŞKAN BANTLI)	230	mt.	11,27
001 157 016016 20 00	16x16 MM KABLO KANALI CANALEX (YAPIŞKAN BANTLI)	240	mt.	13,07
001 157 020010 20 00	20x10 MM KABLO KANALI CANALEX (YAPIŞKAN BANTLI)	200	mt.	13,24
001 157 020015 20 00	20x15 MM KABLO KANALI CANALEX (YAPIŞKAN BANTLI)	180	mt.	19,49
001 157 025016 20 00	25x16 MM KABLO KANALI CANALEX (YAPIŞKAN BANTLI)	150	mt.	20,06
001 157 025025 20 00	25x25 MM KABLO KANALI CANALEX (YAPIŞKAN BANTLI)	100	mt.	26,25
001 157 040016 20 00	40x16 MM KABLO KANALI CANALEX (YAPIŞKAN BANTLI)	100	mt.	34,12
001 157 040025 20 00	40x25 MM KABLO KANALI CANALEX (YAPIŞKAN BANTLI)	80	mt.	37,3
001 157 040040 20 00	40x40 MM KABLO KANALI CANALEX (YAPIŞKAN BANTLI)	50	mt.	46,86
001 157 060040 20 00	60x40 MM KABLO KANALI CANALEX (YAPIŞKAN BANTLI)	40	mt.	65,18
EKO SERİSİ TSE'Lİ KAPALI TİP KABLO KANALLARI				
001 014 010008 20 00	10x08 MM KABLO KANALI EKO	330	mt.	9,95
001 014 012012 20 00	12x12 MM KABLO KANALI EKO	250	mt.	10,55
001 014 015010 20 00	15x10 MM KABLO KANALI EKO	250	mt.	10,72
001 014 015015 20 00	15x15 MM KABLO KANALI EKO	250	mt.	15,07
001 014 016016 20 00	16x16 MM KABLO KANALI EKO	250	mt.	16,07
001 014 020010 20 00	20x10 MM KABLO KANALI EKO	200	mt.	13,15
001 014 025016 20 00	25x16 MM KABLO KANALI EKO	150	mt.	20,57
001 014 025025 20 00	25x25 MM KABLO KANALI EKO	100	mt.	26,79
001 014 025040 20 00	25x40 MM KABLO KANALI EKO	80	mt.	53,43
001 014 930010 20 00	30x10 MM KABLO KANALI EKO (BÖLMELİ)	140	mt.	27,86
001 014 030015 20 00	30x15 MM KABLO KANALI EKO	140	mt.	23,99
001 014 930016 20 00	30x16 MM KABLO KANALI EKO (BÖLMELİ)	140	mt.	31,43
001 014 030016 20 00	30x16 MM KABLO KANALI EKO	140	mt.	28,2
001 014 030025 20 00	30x25 MM KABLO KANALI EKO	80	mt.	39,9
001 014 030030 20 00	30x30 MM KABLO KANALI EKO	80	mt.	36,53
001 014 940016 20 00	40x16 MM KABLO KANALI EKO (BÖLMELİ)	100	mt.	40,35
001 014 040016 20 00	40x16 MM KABLO KANALI EKO	100	mt.	31,21
001 014 040025 20 00	40x25 MM KABLO KANALI EKO	80	mt.	41,07
001 014 040040 20 00	40x40 MM KABLO KANALI EKO	50	mt.	45,28
001 014 040060 20 00	40x60 MM KABLO KANALI EKO	40	mt.	102,89
001 014 960025 20 00	60x25 MM KABLO KANALI EKO (BÖLMELİ)	40	mt.	71,36
001 014 060040 20 00	60x40 MM KABLO KANALI EKO	40	mt.	74,64
001 014 050050 20 00	50x50 MM KABLO KANALI EKO	30	mt.	90,37
001 014 060060 20 00	60x60 MM KABLO KANALI EKO	32	mt.	99,77
001 014 075075 20 00	75x75 MM KABLO KANALI EKO	28	mt.	146,27
001 014 080040 20 00	80x40 MM KABLO KANALI EKO	30	mt.	112,24
001 014 080060 20 00	80x60 MM KABLO KANALI EKO	24	mt.	123,87
001 014 100040 20 00	100x40 MM KABLO KANALI EKO (PRİZ SETİ TAKILABİLİR)	24	mt.	125,85
001 014 100037 20 00	100x37 MM KABLO KANALI İÇTEN KAPAKLI KANAL EKO FOLYOLU (PRİZ SETİ TAKILABİLİR)	30	mt.	139,38
001 014 100050 20 00	100x50 MM KABLO KANALI İÇTEN KAPAKLI KANAL EKO FOLYOLU (PRİZ SETİ TAKILABİLİR)	20	mt.	137,97
001 014 100060 20 00	100x60 MM KABLO KANALI EKO (PRİZ SETİ TAKILABİLİR)	20	mt.	160,91
001 014 120060 20 00	120x60 MM KABLO KANALI EKO	16	mt.	238,19
001 014 100100 20 00	100x100 MM KABLO KANALI EKO	20	mt.	284,05
EKO SERİSİ KAPALI TİP KABLO KANALLARI (YAPIŞKAN BANTLI)				
001 004 009005 20 00	9x5 MM KABLO KANALI KEN.KAPAKLI	500	mt.	15,31
001 004 010007 20 44	9,5x7 MM KABLO KANALI ŞEFFAF KANAL	500	mt.	21,09
001 004 012007 20 00	12x7,5 MM KABLO KANALI KENDİNDEN KAPAKLI	350	mt.	15,87
001 004 013012 20 00	13x12,5 MM KABLO KANALI KENDİNDEN KAPAKLI	300	mt.	19,79
001 004 010008 20 00	10x8 MM KABLO KANALI EKO (YAPIŞKAN BANTLI)	330	mt.	11,48
001 004 010010 20 00	10x10 MM KABLO KANALI EKO KENDİNDEN KAPAKLI (YAPIŞKAN BANTLI)	320	mt.	15,74
001 004 012012 20 00	12x12 MM KABLO KANALI EKO (YAPIŞKAN BANTLI)	250	mt.	12,34
001 004 015010 20 00	15x10 MM KABLO KANALI EKO (YAPIŞKAN BANTLI)	230	mt.	12,86
001 004 016016 20 00	16x16 MM KABLO KANALI EKO (YAPIŞKAN BANTLI)	240	mt.	17,3
001 004 020010 20 00	20x10 MM KABLO KANALI EKO (YAPIŞKAN BANTLI)	180	mt.	15,2
001 004 025016 20 00	25x16 MM KABLO KANALI EKO (YAPIŞKAN BANTLI)	150	mt.	24,32
001 004 025025 20 00	25x25 MM KABLO KANALI EKO (YAPIŞKAN BANTLI)	100	mt.	29,93
001 004 025040 20 00	25x40 MM KABLO KANALI EKO (YAPIŞKAN BANTLI)	80	mt.	57,14
001 004 930010 20 00	30x10 MM KABLO KANALI EKO (YAPIŞKAN BANTLI) (BÖLMELİ)	140	mt.	30,36
001 004 030016 20 00	30x16 MM KABLO KANALI EKO (YAPIŞKAN BANTLI)	140	mt.	31,25
001 004 030025 20 00	30x25 MM KABLO KANALI EKO (YAPIŞKAN BANTLI)	80	mt.	42,86
001 004 040016 20 00	40x16 MM KABLO KANALI EKO (YAPIŞKAN BANTLI)	100	mt.	35,59
001 004 040025 20 00	40x25 MM KABLO KANALI EKO (YAPIŞKAN BANTLI)	80	mt.	50,06
001 004 040040 20 00	40x40 MM KABLO KANALI EKO (YAPIŞKAN BANTLI)	50	mt.	53,63
001 004 060040 20 00	60x40 MM KABLO KANALI EKO (YAPIŞKAN BANTLI)	40	mt.	81,4

Ürün Kodu	Ürün Adı	Amb. (Kutu)	Amb. Birimi	Fiyat (₺)
MEKS SERİSİ TSE'Lİ KAPALI TİP KABLO KANALLARI				
001 002 015015 20 00	15x15 MM KABLO KANALI MEKS	250	mt.	18,11
001 002 016016 20 00	16x16 MM KABLO KANALI MEKS	250	mt.	19,85
001 002 025016 20 00	25x16 MM KABLO KANALI MEKS	150	mt.	26,43
001 002 025025 20 00	25x25 MM KABLO KANALI MEKS	100	mt.	35
001 002 030015 20 00	30x15 MM KABLO KANALI MEKS	140	mt.	33,52
001 002 030030 20 00	30x30 MM KABLO KANALI MEKS	80	mt.	44,6
001 002 040017 20 00	40x17 MM KABLO KANALI TAM KAPAKLI MEKS	100	mt.	48,23
001 002 940017 20 00	40x17 MM KABLO KANALI TAM KAPAKLI MEKS (BÖLMELİ)	100	mt.	52
001 002 040025 20 00	40x25 MM KABLO KANALI MEKS	80	mt.	48,93
001 002 040040 20 00	40x40 MM KABLO KANALI MEKS	50	mt.	56,79
001 002 960025 20 00	60x25 MM KABLO KANALI MEKS (BÖLMELİ)	40	mt.	79,11
001 002 060040 20 00	60x40 MM KABLO KANALI MEKS	40	mt.	76,79
001 002 080060 20 00	80x60 MM KABLO KANALI MEKS	24	mt.	129,31
001 002 100040 20 00	100x40 MM KABLO KANALI MEKS (PRİZ SETİ TAKILABİLİR)	24	mt.	161,88
001 002 100048 20 00	100x48 MM KABLO KANALI MEKS (PRİZ SETİ TAKILABİLİR)	24	mt.	209,14
001 002 100060 20 00	100x60 MM KABLO KANALI MEKS (PRİZ SETİ TAKILABİLİR)	20	mt.	207,14
001 002 120060 20 00	120x60 MM KABLO KANALI MEKS	16	mt.	261,48
MEKS SERİSİ İÇTEN KAPAKLI KAPALI TİP KABLO KANALLARI				
001 002 100037 20 00	100x37 MM KABLO KANALI MEKS (İÇTEN KAPAKLI)(FOLYOLU)	30	mt.	182,55
001 002 100041 20 00	100x41 MM KABLO KANALI MEKS (İÇTEN KAPAKLI)(FOLYOLU)	24	mt.	180,67
001 002 100050 20 00	100x50 MM KABLO KANALI MEKS (İÇTEN KAPAKLI)(FOLYOLU)	20	mt.	187,52
001 002 120070 20 00	120x70 MM KABLO KANALI (İÇTEN KAPAKLI)(AKSESUARLARI)	16	mt.	286,37
001 002 170070 20 00	170x70 MM KABLO KANALI (İÇTEN KAPAKLI)(AKSESUARLARI)	12	mt.	378,57
001 002 250070 20 00	250x70 MM KABLO KANALI (İÇTEN KAPAKLI)(AKSESUARLARI)	8	mt.	593,6
MEKSPUS SERİSİ KAPALI TİP KABLO KANALLARI				
001 003 100037 20 00	100x37 MM KABLO KANALI (İÇTEN KAPAKLI)	30	mt.	187,4
001 003 100041 20 00	100x41 MM KABLO KANALI (İÇTEN KAPAKLI)	24	mt.	190,56
001 003 100050 20 00	100x50 MM KABLO KANALI (İ. KAP.)(ET KALINLIĞI 2MM)	20	mt.	225,84
001 006 100050 20 00	100x50 MM KABLO KANALI (İÇTEN KAPAKLI)(KAİDESİZ SERİ)	20	mt.	242,76
001 003 120070 20 00	120x70 MM KABLO KANALI (İÇTEN KAPAKLI)(AKSESUARLARI)	16	mt.	333,76
001 003 170050 20 00	170x50 MM KABLO KANALI (İÇTEN KAPAKLI)	12	mt.	426,67
001 003 170070 20 00	170x70 MM KABLO KANALI (İÇTEN KAPAKLI)(AKSESUARLARI)	12	mt.	516,58
001 003 250070 20 00	250x70 MM KABLO KANALI (İÇTEN KAPAKLI)(AKSESUARLARI)	8	mt.	649,01
MEKS SERİSİ KLİMA KANALI ve AKSESUARLARI				
001 002 075060 20 00	75x60 MM KLİMA KANALI	30	mt.	125,92
001 050 030002 00 00	KLİMA KANALI KABLO TUTUCUSU	60	ad.	19,06
001 043 075060 00 00	KLİMA KANALI EK PARÇASI	40	ad.	22,76
001 039 075060 00 00	KLİMA KANALI İÇ KÖŞE	24	ad.	45,79
001 040 075060 00 00	KLİMA KANALI DIŞ KÖŞE	24	ad.	45,79
001 042 075060 00 00	KLİMA KANALI L KÖŞE	18	ad.	45,79
001 050 030001 00 00	KLİMA KANALI DUVAR GEÇİŞİ	60	ad.	27,21
001 044 075060 01 00	KLİMA KANALI İÇ SONLAMA	30	ad.	44,54
001 044 075060 02 00	KLİMA KANALI DIŞ SONLAMA	18	ad.	45,21
TAVAN KÖŞE KANALI (23x23) ve AKSESUARLARI				
001 002 023023 20 00	23x23 MM TAVAN KÖŞE KANALI	120	mt.	49,16
001 041 023023 00 00	23x23 MM T PARÇASI	60	ad.	13,75
001 042 023023 00 00	23x23 MM 90 L KÖŞE	60	ad.	14,04
001 043 023023 00 00	23x23 MM EK PARÇA	100	ad.	11,15
001 044 023023 00 00	23x23 MM UÇ TAPA	100	ad.	11,39
SÜPÜRGELİK KABLO KANALLARI ve AKSESUARLARI				
001 010 000200 20 00	50'LİK FUGALI SÜPÜRGELİK	60	mt.	46,57
001 014 974020 20 00	74x20 MM KABLO KANALI EKO (BÖLMELİ)	50	mt.	102,18
001 039 074020 00 00	74x20 İÇ KÖŞE	20	ad.	34,04
001 040 074020 00 00	74x20 DIŞ KÖŞE	20	ad.	33,45
001 041 074020 00 00	74x20 T KÖŞE	30	ad.	39,22
001 042 074020 01 00	74x20 90 L KÖŞE	40	ad.	39,22
001 043 074020 00 00	74x20 EK PARÇA	50	ad.	18,11
001 044 074020 00 00	74x20 UÇ TAPA	50	ad.	18,11
001 047 017420 00 00	74x20 PRİZ MONTAJ KASASI	6	ad.	101,24
001 047 017421 00 00	74x20 1' Lİ PRİZ MONTAJ KASASI	12	ad.	179,1
001 002 975022 20 00	75x22 MM KABLO KANALI (BÖLMELİ)	50	mt.	140,52
001 039 075022 00 00	75x22 MM İÇ KÖŞE	20	ad.	15,78
001 040 075022 00 00	75x22 MM DIŞ KÖŞE	20	ad.	15,79
001 044 075022 01 00	75x22 MM SAĞ SONLAMA	30	ad.	22,42
001 044 075022 02 00	75x22 MM SOL SONLAMA	20	ad.	22,86
001 043 075022 00 00	75x22 MM EK PARÇASI	100	ad.	21,48
TEZGAH SÜPÜRGELİĞİ				
001 011 000100 00 00	25'LİK TEZGAH SÜPÜRGELİĞİ 100CM	60	mt.	53
BALIK SIRTI KANALLARI				
001 002 050013 20 17	50x13 MM BALIK SIRTI KANAL (ZEMİN İÇİN)	60	mt.	57,45
001 002 060015 20 17	60x15 MM BALIK SIRTI KANAL (ZEMİN İÇİN)	40	mt.	66,29
001 002 075018 20 17	75x18 MM BALIK SIRTI KANAL (ZEMİN İÇİN)	30	mt.	110,26
001 002 090020 20 17	90x20 MM BALIK SIRTI KANAL (ZEMİN İÇİN)	20	mt.	140,9
001 004 050013 20 17	50x13 MM KABLO KANALI BALIK SIRTI (YAPIŞKAN BANTLI)	60	mt.	66,42
001 004 060015 20 17	60x15 MM KABLO KANALI BALIK SIRTI (YAPIŞKAN BANTLI)	40	mt.	73,13
001 004 075018 20 17	75x18 MM KABLO KANALI BALIK SIRTI (YAPIŞKAN BANTLI)	30	mt.	118,95
001 004 090020 20 17	90x20 MM KABLO KANALI BALIK SIRTI (YAPIŞKAN BANTLI)	20	mt.	154,56





Ürün Kodu	Ürün Adı	Amb. (Kutu)	Amb. Birimi	Fiyat (₺)
H.FREE FLARET SERİSİ KAPALI TİP KABLO KANALLARI				
001 060 100050 20 00	100x50 MM KABLO KANALI İÇTEN KAPAKLI HALOJEN FREE	20	mt.	594
001 061 100050 20 00	100x50 MM KABLO KANALI ARA BÖLME HALOJEN FREE	150	mt.	74,57
001 039 100050 11 00	100x50-37 MM KABLO KANALI İÇ KÖŞE(HAREKETLİ) HALOJEN FREE	12	ad.	65,02
001 040 100050 11 00	100x50 MM KABLO KANALI DIŞ KÖŞE(HAREKETLİ) HALOJEN FREE	10	ad.	65
001 041 100050 11 00	100x50 MM KABLO KANALI T PARÇASI HALOJEN FREE	10	ad.	72,2
001 042 100050 11 00	100x50 MM KABLO KANALI 90 L KÖŞE HALOJEN FREE	10	ad.	72,21
001 043 100050 11 00	100x50 MM KABLO KANALI EK PARÇA(UÇLU SET) HALOJEN FREE	100	ad.	22,38
001 044 100050 11 00	100x50 MM KABLO KANALI UÇ TAPA HALOJEN FREE	40	ad.	22,49
001 047 100001 11 00	PMS(100x37/50)(45X45)(1LÜ) HALOJEN FREE	20	ad.	48,12
001 047 100002 11 00	PMS(100x37/50)(45X45)(2LÜ) HALOJEN FREE	14	ad.	71,59
001 047 100003 11 00	PMS(100x37/50)(45X45)(3LÜ) HALOJEN FREE	12	ad.	100,86
H.FREE FLARET SERİSİ KAPALI TİP KABLO KANALLARI				
001 060 025016 20 00	25x16 MM KABLO KANALI HALOJEN FREE	150	mt.	110,53
001 060 025025 20 00	25x25 MM KABLO KANALI HALOJEN FREE	100	mt.	120,15
001 060 040025 20 00	40x25 MM KABLO KANALI HALOJEN FREE	80	mt.	175,83
001 060 040040 20 00	40x40 MM KABLO KANALI HALOJEN FREE	50	mt.	204,46
25x16 H.FREE FLARET KANAL AKSESUARLARI				
001 039 025016 11 00	25x16 MM İÇ KÖŞE	40	ad.	15,41
001 040 025016 11 00	25x16 MM DIŞ KÖŞE	40	ad.	15,39
001 041 025016 11 00	25x16 MM T PARÇASI	30	ad.	20,4
001 042 025016 11 00	25x16 MM 90 L KÖŞE	80	ad.	20,4
001 043 025016 11 00	25x16 MM EK PARÇA	100	ad.	13,43
001 044 025016 11 00	25x16 MM UÇ TAPA	100	ad.	13,43
25x25 H.FREE FLARET KANAL AKSESUARLARI				
001 039 025025 11 00	25x25 MM İÇ KÖŞE	40	ad.	14,8
001 040 025025 11 00	25x25 MM DIŞ KÖŞE	40	ad.	14,8
001 041 025025 11 00	25x25 MM T PARÇASI	30	ad.	23,92
001 042 025025 11 00	25x25 MM 90 L KÖŞE	50	ad.	23,92
001 043 025025 11 00	25x25 MM EK PARÇA	100	ad.	14,13
001 044 025025 11 00	25x25 MM UÇ TAPA	100	ad.	14,13
40x25 H.FREE FLARET KANAL AKSESUARLARI				
001 039 040025 11 00	40x25 MM İÇ KÖŞE	24	ad.	42,96
001 040 040025 11 00	40x25 MM DIŞ KÖŞE	30	ad.	42,96
001 041 040025 11 00	40x25 MM T PARÇASI	18	ad.	53,6
001 042 040025 11 00	40x25 MM 90 L KÖŞE	24	ad.	53,6
001 043 040025 11 00	40x25 MM EK PARÇA	70	ad.	32,5
001 044 040025 11 00	40x25 MM UÇ TAPA	25	ad.	32,51
40x40 H.FREE FLARET KANAL AKSESUARLARI				
001 039 040040 11 00	40x40 MM İÇ KÖŞE	18	ad.	47
001 040 040040 11 00	40x40 MM DIŞ KÖŞE	16	ad.	47
001 041 040040 11 00	40x40 MM T PARÇASI	48	ad.	48,8
001 042 040040 11 00	40x40 MM 90 L KÖŞE	60	ad.	48,8
001 043 040040 11 00	40x40 MM EK PARÇA	100	ad.	32,68
001 044 040040 11 00	40x40 MM UÇ TAPA	25	ad.	32,67



Ürün Kodu	Ürün Adı	Amb. (Kutu)	Amb. Birimi	Fiyat (₺)
BALIK SIRTI 60x15 AKSESUARLARI				
001 042 060015 00 17	60x15 MM BALIK SIRTI KANAL L KÖŞE	24	ad.	23,11
001 043 060015 00 17	60x15 MM BALIK SIRTI KANAL EK PARÇASI	50	ad.	14,06
001 044 060015 00 17	60x15 MM BALIK SIRTI KANAL SONLAMA KAPAĞI	50	ad.	13,21
001 041 060015 00 17	60x15 MM BALIK SIRTI KANAL T KÖŞE	10	ad.	36,79
BALIK SIRTI 75x18 AKSESUARLARI				
001 042 075018 00 17	75x18 MM BALIK SIRTI KANAL L KÖŞE	15	ad.	39,77
001 043 075018 00 17	75x18 MM BALIK SIRTI KANAL EK PARÇASI	50	ad.	18,13
001 044 075018 00 17	75x18 MM BALIK SIRTI KANAL SONLAMA KAPAĞI	50	ad.	9,96
001 041 075018 00 17	75x18 MM BALIK SIRTI KANAL T KÖŞE	8	ad.	40,91
BALIK SIRTI 90x20 AKSESUARLARI				
001 042 090020 00 17	90x20 MM BALIK SIRTI KANAL KANAL L KÖŞE	20	ad.	43,47
001 043 090020 00 17	90x20 MM BALIK SIRTI KANAL EK PARÇASI	50	ad.	11,2
001 044 090020 00 17	90x20 MM BALIK SIRTI KANAL SONLAMA KAPAĞI	50	ad.	15,61
001 041 090020 00 17	90x20 MM BALIK SIRTI KANAL T KÖŞE	12	ad.	37,67
12X12 KANAL AKSESUARLARI				
001 039 012012 00 00	12x12 MM İÇ KÖŞE	60	ad.	11
001 040 012012 00 00	12x12 MM DIŞ KÖŞE	60	ad.	11
001 041 012012 00 00	12x12 MM T KÖŞE	60	ad.	11,43
001 042 012012 00 00	12x12 MM 90 L KÖŞE	60	ad.	11,43
001 044 012012 00 00	12x12 MM UÇ TAPA	100	ad.	10,07
001 043 012012 00 00	12x12 MM EK PARÇASI	100	ad.	10,07
15X10 KANAL AKSESUARLARI				
001 039 015010 00 00	15x10 MM İÇ KÖŞE	60	ad.	11,43
001 040 015010 00 00	15x10 MM DIŞ KÖŞE	60	ad.	11,43
001 041 015010 00 00	15x10 MM T KÖŞE	60	ad.	12,11
001 042 015010 00 00	15x10 MM 90 L KÖŞE	60	ad.	12,11
001 044 015010 00 00	15x10 MM UÇ TAPA	100	ad.	11,11
001 043 015010 00 00	15x10 MM EK PARÇASI	100	ad.	11,11
20X10 KANAL AKSESUARLARI				
001 039 020010 00 00	20x10 MM İÇ KÖŞE	60	ad.	9,29
001 040 020010 00 00	20x10 MM DIŞ KÖŞE	60	ad.	9,29
001 041 020010 00 00	20x10 MM T KÖŞE	30	ad.	12,43
001 042 020010 00 00	20x10 MM 90 L KÖŞE	50	ad.	12,43
001 044 020010 00 00	20x10 MM UÇ TAPA	100	ad.	8,18
001 043 020010 00 00	20x10 MM EK PARÇASI	100	ad.	8,18
16X16 KANAL AKSESUARLARI				
001 039 016016 00 00	16x16 MM İÇ KÖŞE	100	ad.	12,14
001 040 016016 00 00	16x16 MM DIŞ KÖŞE	100	ad.	12,14
001 041 016016 00 00	16x16 MM T KÖŞE	60	ad.	16,07
001 042 016016 00 00	16x16 MM 90 L KÖŞE	60	ad.	16,07
001 044 016016 00 00	16x16 MM UÇ TAPA	100	ad.	11,11
001 043 016016 00 00	16x16 MM EK PARÇASI	100	ad.	11,11
25X16 KANAL AKSESUARLARI				
001 039 025016 00 00	25x16 MM İÇ KÖŞE	40	ad.	12,32
001 040 025016 00 00	25x16 MM DIŞ KÖŞE	40	ad.	12,32
001 041 025016 00 00	25x16 MM T KÖŞE	30	ad.	18,21
001 042 025016 00 00	25x16 MM 90 L KÖŞE	80	ad.	18,21
001 044 025016 00 00	25x16 MM UÇ TAPA	100	ad.	11,99
001 043 025016 00 00	25x16 MM EK PARÇASI	100	ad.	11,99
001 047 017421 00 00	25x16 MM PMK (45x45)	12	ad.	179,1
25X25 KANAL AKSESUARLARI				
001 039 025025 00 00	25x25 MM İÇ KÖŞE	40	ad.	13,21
001 040 025025 00 00	25x25 MM DIŞ KÖŞE	40	ad.	13,21
001 041 025025 00 00	25x25 MM T KÖŞE	24	ad.	21,36
001 042 025025 00 00	25x25 MM 90 L KÖŞE	40	ad.	21,36
001 044 025025 00 00	25x25 MM UÇ TAPA	100	ad.	12,61
001 043 025025 00 00	25x25 MM EK PARÇASI	50	ad.	12,61
001 047 017421 00 00	25x25 MM PMK (45x45)	12	ad.	179,1
30X10 KANAL AKSESUARLARI				
001 039 030010 00 00	30x10 MM İÇ KÖŞE	50	ad.	18,57
001 040 030010 00 00	30x10 MM DIŞ KÖŞE	50	ad.	18,57
001 041 030010 00 00	30x10 MM T KÖŞE	50	ad.	29,19
001 042 030010 00 00	30x10 MM 90 L KÖŞE	50	ad.	29,19
001 044 030025 00 00	30x10-16-25 MM UÇ TAPA	100	ad.	11,18
001 043 030025 00 00	30x10-16-25 MM EK PARÇASI	100	ad.	11,18
30X16 KANAL AKSESUARLARI				
001 039 030016 00 00	30x16 MM İÇ KÖŞE	35	ad.	33,41
001 040 030016 00 00	30x16 MM DIŞ KÖŞE	48	ad.	33,41
001 041 030016 00 00	30x16 MM T KÖŞE	40	ad.	34,64
001 042 030016 00 00	30x16 MM 90 L KÖŞE	50	ad.	34,64
001 044 030025 00 00	30x10-16-25 MM UÇ TAPA	100	ad.	17,5
001 043 030025 00 00	30x10-16-25 MM EK PARÇASI	100	ad.	17,5
30X25 KANAL AKSESUARLARI				
001 039 030025 00 00	30x25 MM İÇ KÖŞE	30	ad.	29,5
001 040 030025 00 00	30x25 MM DIŞ KÖŞE	32	ad.	29,5
001 041 030025 00 00	30x25 MM T KÖŞE	24	ad.	30,71
001 042 030025 00 00	30x25 MM 90 L KÖŞE	30	ad.	30,71
001 044 030025 00 00	30x10-16-25 MM UÇ TAPA	100	ad.	17,5
001 043 030025 00 00	30x10-16-25 MM EK PARÇASI	100	ad.	17,5



EK PARÇA



T KÖŞE

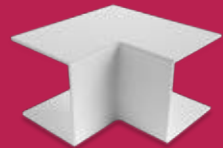

İÇ KÖŞE



DIŞ KÖŞE



L KÖŞE



UÇ TAPA



UÇ TAPA



T KÖŞE

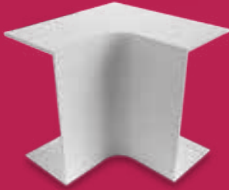

İÇ KÖŞE







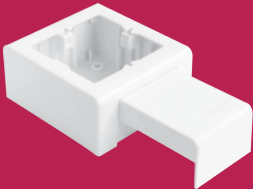



EK PARÇA

PRİZ MONTAJ KASASI



Ürün Kodu	Ürün Adı	Amb. (Kutu)	Amb. Birimi	Fiyat (₺)
40X16 KANAL AKSESUARLARI				
Ⓢ Ⓢ CE IP40				
001 039 040016 00 00	40x16 MM İÇ KÖŞE	32	ad.	38,04
001 040 040016 00 00	40x16 MM DİŞ KÖŞE	30	ad.	38,04
001 041 040016 00 00	40x16 MM T KÖŞE	24	ad.	44,96
001 042 040016 00 00	40x16 MM 90 L KÖŞE	34	ad.	44,96
001 044 040040 00 00	40x16-25-40 MM UÇ TAPA	25	ad.	29,04
001 043 040016 00 00	40x16-25-40 MM EK PARÇASI	100	ad.	29,04
001 047 017421 00 00	40x165 MM PMK (45x45)	12	ad.	179,1
40X25 KANAL AKSESUARLARI				
Ⓢ Ⓢ CE IP40				
001 039 040025 00 00	40x25 MM İÇ KÖŞE	24	ad.	38,36
001 040 040025 00 00	40x25 MM DİŞ KÖŞE	30	ad.	38,36
001 041 040025 00 00	40x25 MM T KÖŞE	18	ad.	47,86
001 042 040025 00 00	40x25 MM 90 L KÖŞE	24	ad.	47,86
001 044 040040 00 00	40x16-25-40 MM UÇ TAPA	25	ad.	29,04
001 043 040016 00 00	40x16-25-40 MM EK PARÇASI	100	ad.	29,04
001 047 017421 00 00	40x25 MM PMK (45x45)	12	ad.	179,1
40X40 KANAL AKSESUARLARI				
Ⓢ Ⓢ CE IP40				
001 039 040040 01 00	40x40 MM İÇ KÖŞE (HAREKETLİ)	18	ad.	41,96
001 040 040040 01 00	40x40 MM DİŞ KÖŞE (HAREKETLİ)	16	ad.	41,96
001 041 040040 00 00	40x40 MM T KÖŞE	48	ad.	43,57
001 042 040040 00 00	40x40 MM 90 L KÖŞE	60	ad.	43,57
001 044 040040 00 00	40x16-25-40 MM UÇ TAPA	50	ad.	29,04
001 043 040016 00 00	40x16-25-40 MM EK PARÇASI	100	ad.	29,04
001 047 017421 00 00	40x40 MM PMK (45x45)	12	ad.	179,1
60X25 KANAL AKSESUARLARI				
Ⓢ Ⓢ CE IP40				
001 039 060025 00 00	60x25 MM İÇ KÖŞE	48	ad.	28,19
001 040 060025 00 00	60x25 MM DİŞ KÖŞE	72	ad.	28,18
001 041 060025 00 00	60x25 MM T KÖŞE	40	ad.	33,86
001 042 060025 00 00	60x25 MM 90 L KÖŞE	60	ad.	33,86
001 044 060025 00 00	60x25 MM UÇ TAPA	50	ad.	19,82
001 043 060025 00 00	60x25 MM EK PARÇASI	60	ad.	19,82
60X40 KANAL AKSESUARLARI				
Ⓢ Ⓢ CE IP40				
001 039 060040 00 00	60x40 MM İÇ KÖŞE	26	ad.	35,57
001 040 060040 00 00	60x40 MM DİŞ KÖŞE	32	ad.	35,57
001 041 060040 00 00	60x40 MM T KÖŞE	32	ad.	36,5
001 042 060040 00 00	60x40 MM 90 L KÖŞE	40	ad.	36,5
001 044 060040 00 00	60x40 MM UÇ TAPA	50	ad.	19,93
001 043 060040 00 00	60x40 MM EK PARÇASI	40	ad.	19,93
60X60 KANAL AKSESUARLARI				
Ⓢ Ⓢ CE IP40				
001 039 060060 01 00	60x60 MM İÇ KÖŞE (HAREKETLİ)	16	ad.	49,71
001 040 060060 01 00	60x60 MM DİŞ KÖŞE (HAREKETLİ)	16	ad.	49,71
001 041 060060 00 00	60x60 MM T KÖŞE	20	ad.	63,56
001 042 060060 00 00	60x60 MM 90 L KÖŞE	24	ad.	63,56
001 044 060060 00 00	60x60 MM UÇ TAPA	30	ad.	33,03
001 043 060060 00 00	60x60 MM EK PARÇASI	25	ad.	33,03
80X40 KANAL AKSESUARLARI				
Ⓢ Ⓢ CE IP40				
001 039 080040 00 00	80x40 MM İÇ KÖŞE	18	ad.	58,79
001 040 080040 00 00	80x40 MM DİŞ KÖŞE	8	ad.	58,79
001 041 080040 00 00	80x40 MM T KÖŞE	12	ad.	63,94
001 042 080040 00 00	80x40 MM 90 L KÖŞE	16	ad.	63,94
001 044 080040 00 00	80x40 MM UÇ TAPA	60	ad.	47,32
001 043 080040 00 00	80x40 MM EK PARÇASI	100	ad.	47,32
80X60 KANAL AKSESUARLARI				
Ⓢ Ⓢ CE IP40				
001 039 080060 00 00	80x60 MM İÇ KÖŞE	12	ad.	62,75
001 040 080060 00 00	80x60 MM DİŞ KÖŞE	8	ad.	62,75
001 041 080060 00 00	80x60 MM T KÖŞE	10	ad.	70,45
001 042 080060 00 00	80x60 MM 90 L KÖŞE	12	ad.	70,45
001 044 080060 00 00	80x60 MM UÇ TAPA	48	ad.	49,29
001 043 080060 00 00	80x60 MM EK PARÇASI	80	ad.	49,29
100X37 KANAL AKSESUARLARI				
Ⓢ Ⓢ CE IP40				
001 039 100037 00 00	100x37 MM İÇ KÖŞE (SABİT)	12	ad.	48,5
001 040 100037 00 00	100x37 MM DİŞ KÖŞE (SABİT)	8	ad.	48,5
001 039 100037 01 00	100x37 MM İÇ KÖŞE (HAREKETLİ)	12	ad.	48,5
001 040 100037 01 00	100x37 MM DİŞ KÖŞE (HAREKETLİ)	10	ad.	48,5
001 041 100037 00 00	100x37 MM T PARÇASI	14	ad.	53,14
001 042 100037 00 00	100x37 MM 90 L KÖŞE	14	ad.	53,14
001 044 100037 00 00	100x37 MM UÇ TAPA	50	ad.	26,11
001 043 100037 00 00	100x37 MM EK PARÇA	100	ad.	26,11
100X40 KANAL AKSESUARLARI				
Ⓢ Ⓢ CE IP40				
001 039 100040 00 00	100x40 MM İÇ KÖŞE (SABİT)	8	ad.	59,64
001 040 100040 00 00	100x40 MM DİŞ KÖŞE (SABİT)	8	ad.	59,64
001 039 100040 01 00	100x40 MM İÇ KÖŞE (HAREKETLİ)	16	ad.	59,64
001 040 100040 01 00	100x40 MM DİŞ KÖŞE (HAREKETLİ)	10	ad.	59,64
001 041 100040 00 00	100x40 MM T PARÇASI	12	ad.	74,89
001 042 100040 00 00	100x40 MM 90 L KÖŞE	12	ad.	74,89
001 044 100040 00 00	100x40 MM UÇ TAPA	20	ad.	27,32
001 043 100040 00 00	100x40 MM EK PARÇA	100	ad.	27,32
001 050 030004 00 00	100x40 MM KANAL KİLİTLEME APARATI	100	ad.	9,89
001 013 100040 20 00	100x40 MM ARA BÖLME	200	mt.	35

Ürün Kodu	Ürün Adı	Amb. (Kutu)	Amb. Birimi	Fiyat (₺)
100X48 KANAL AKSESUARLARI  CE IP40				
001 039 100048 00 00	100X48 MM İÇ KÖŞE (SABİT)	8	ad.	61,18
001 040 100048 00 00	100X48 MM DIŞ KÖŞE (SABİT)	8	ad.	61,18
001 039 100048 01 00	100X48 MM İÇ KÖŞE (HAREKETLİ)	10	ad.	61,18
001 040 100048 01 00	100X48 MM DIŞ KÖŞE (HAREKETLİ)	10	ad.	61,18
001 041 100048 00 00	100X48 MM T PARÇASI	8	ad.	76,71
001 042 100048 00 00	100X48 MM 90 L KÖŞE	8	ad.	76,71
001 044 100048 00 00	100X48 MM UÇ TAPA	20	ad.	30,96
001 043 100048 00 00	100X48 MM EK PARÇA	100	ad.	30,96
001 050 030004 00 00	100X48 MM KANAL KİLİTLEME APARATI	100	ad.	9,89
001 013 100048 20 00	100X48 MM ARA BÖLME	150	mt.	28,89
100X50/41 KANAL AKSESUARLARI  CE IP40				
001 039 100050 00 00	100X50/41 MM İÇ KÖŞE (SABİT)	8	ad.	38,51
001 040 100050 00 00	100X50/41 MM DIŞ KÖŞE (SABİT)	8	ad.	38,51
001 039 100050 01 00	100X50/41 MM İÇ KÖŞE (HAREKETLİ)	10	ad.	38,51
001 040 100050 01 00	100X50/41 MM DIŞ KÖŞE (HAREKETLİ)	8	ad.	38,51
001 041 100050 00 00	100X50/41 MM T PARÇASI	10	ad.	50,07
001 042 100050 00 00	100X50/41 MM 90 L KÖŞE	10	ad.	50,07
001 044 100050 00 00	100X50/41 MM UÇ TAPA	40	ad.	26,61
001 043 100050 00 00	100X50/41 MM EK PARÇA	100	ad.	26,61
001 043 100050 01 00	100X50 MM EK PARÇA (3LÜ SET)	100	ad.	26,61
001 046 195100 00 00	100X50 MM KANAL İÇİ KÜP BUAZ	25	ad.	39,64
001 013 100048 20 00	100X48 - 100X50 MM ARA BÖLME	150	mt.	28,89
100X50 KAİDESİZ KANAL AKSESUARLARI  CE IP40				
001 039 100051 00 00	100X50 MM KAİDESİZ İÇ KÖŞE	8	ad.	45,54
001 040 100051 00 00	100X50 MM KAİDESİZ DIŞ KÖŞE	8	ad.	45,54
001 041 100051 00 00	100X50 MM KAİDESİZ T PARÇASI	10	ad.	65,39
001 042 100051 00 00	100X50 MM KAİDESİZ 90 L KÖŞE	10	ad.	65,39
001 043 100051 00 00	100X50 MM KAİDESİZ EK PARÇA	100	ad.	35,36
001 044 100051 00 00	100X50 MM KAİDESİZ UÇ TAPA	40	ad.	35,36
001 888 100050 00 00	100X50 MM KABLO KANALI MONTAJ APARATI	50	ad.	37,22
100X60 KANAL AKSESUARLARI  CE IP40				
001 039 100060 00 00	100X60 MM İÇ KÖŞE (SABİT)	8	ad.	66
001 040 100060 00 00	100X60 MM DIŞ KÖŞE (SABİT)	8	ad.	66
001 039 100060 01 00	100X60 MM İÇ KÖŞE (HAREKETLİ)	8	ad.	66
001 040 100060 01 00	100X60 MM DIŞ KÖŞE (HAREKETLİ)	10	ad.	66
001 041 100060 00 00	100X60 MM T PARÇASI	8	ad.	75,82
001 042 100060 00 00	100X60 MM 90 L KÖŞE	8	ad.	75,82
001 044 100060 00 00	100X60 MM UÇ TAPA	16	ad.	20,08
001 043 100060 00 00	100X60 MM EK PARÇA	100	ad.	20,08
001 050 030004 00 00	100X60 MM KANAL KİLİTLEME APARATI	100	ad.	9,89
001 013 100060 20 00	100X60 MM ARA BÖLME	130	ad.	43,21
120X60 KANAL AKSESUARLARI  CE IP40				
001 039 120060 00 00	120X60 MM İÇ KÖŞE	8	ad.	77,14
001 040 120060 00 00	120X60 MM DIŞ KÖŞE	8	ad.	77,14
001 041 120060 00 00	120X60 MM T PARÇA	8	ad.	80,82
001 042 120060 00 00	120X60 MM 90 L KÖŞE	8	ad.	80,82
001 044 120060 00 00	120X60 MM UÇ TAPA	20	ad.	25,4
001 043 120060 00 00	120X60 MM EK PARÇA	50	ad.	25,39
170X50 KANAL AKSESUARLARI  CE IP40				
001 039 170050 00 00	170X50 MM İÇ KÖŞE	32	ad.	95,36
001 040 170050 00 00	170X50 MM DIŞ KÖŞE	44	ad.	95,36
001 041 170050 00 00	170X50 MM T PARÇA	16	ad.	114,41
001 042 170050 00 00	170X50 MM 90 L KÖŞE	16	ad.	114,41
001 044 170050 00 00	170X50 MM UÇ TAPA	125	ad.	31,07
001 043 170050 00 00	170X50 MM EK PARÇA	125	ad.	31,07
İÇTEN KAPAKLI 100X37/50 İÇİN PRİZ MONTAJ SETİ (45x45)  CE IP40				
001 047 070001 00 00	100X37/50 İÇİN 45X45 PMS (TEKLİ)	20	ad.	29,95
001 047 070002 00 00	100X37/50 İÇİN 45X45 PMS (İKİLİ)	14	ad.	40,08
001 047 070003 00 00	100X37/50 İÇİN 45X45 PMS (ÜÇLÜ)	12	ad.	45,76
001 047 070004 00 00	100X37/50 İÇİN 45X45 PMS (DÖRTLÜ)	10	ad.	80,38
İÇTEN KAPAKLI 100X37/50 İÇİN PRİZ MONTAJ SETİ (55X55)				
001 047 080001 00 00	100X37/50 İÇİN 55X55 PMS (TEKLİ)	20	ad.	46,25
001 047 080002 00 00	100X37/50 İÇİN 55X55 PMS (İKİLİ)	14	ad.	76,85
001 047 080003 00 00	100X37/50 İÇİN 55X55 PMS (ÜÇLÜ)	12	ad.	92,19
DIŞTAN KAPAKLI 100'LÜK KANAL PRİZ MONTAJ SETİ (55X55)				
001 047 020001 00 00	100'LÜK 55X55 PMS TEKLİ	20	ad.	75,03
001 047 020002 00 00	100'LÜK 55X55 PMS İKİLİ	14	ad.	93,97
001 047 020003 00 00	100'LÜK 55X55 PMS ÜÇLÜ	12	ad.	116,43
DIŞTAN KAPAKLI 100'LÜK KANAL PRİZ MONTAJ SETİ (45x45)  CE IP40				
001 047 040001 00 00	100'LÜK 45X45 PMS TEKLİ	20	ad.	59,59
001 047 040002 00 00	100'LÜK 45X45 PMS İKİLİ	14	ad.	85,89
001 047 040003 00 00	100'LÜK 45X45 PMS ÜÇLÜ	12	ad.	120
001 047 040004 00 00	100'LÜK 45X45 PMS DÖRTLÜ	10	ad.	128,57
İNGİLİZ NORMU PRİZ MONTAJ SETLERİ (100x50/37)				
001 047 980001 00 00	İNGİLİZ NORMU TEKLİ PRİZ TABANI	200	ad.	30,4
001 047 980002 00 00	İNGİLİZ NORMU İKİLİ PRİZ TABANI	100	ad.	32,53
001 047 990002 00 00	İNGİLİZ NORMU İKİLİ YÜKSEK TİP PRİZ TABANI	94	ad.	61,49
001 166 000001 00 00	SIVA ALTI ANAHTAR KASASI	28	ad.	31,04

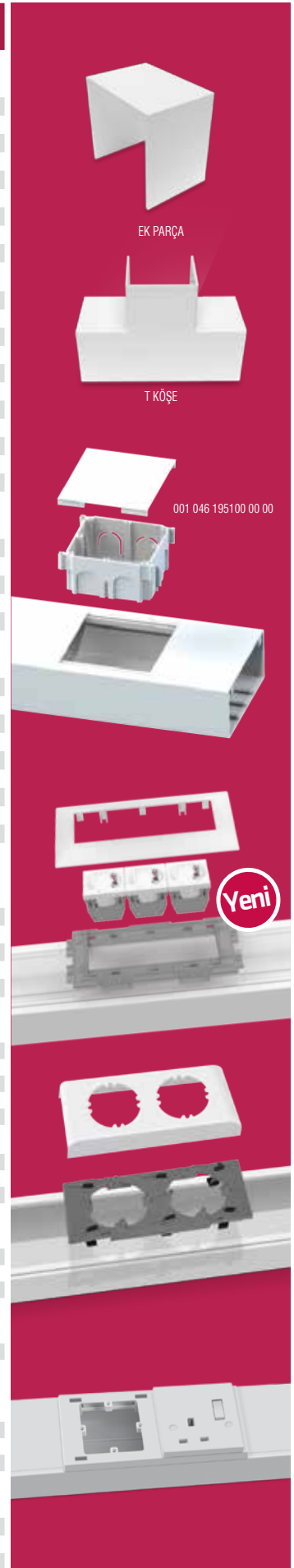



KANAL İÇİN UPS VE ENERJİ PRİZLERİ (45x45)



ÜRÜN KODU	001 052 300001 00 00
ÜRÜN ADI	45x45 TOP.P. ÇEKİRDEĞİ ÇCK. KOR. (45°)
AMB. AD./KOLİ	50/300
FİYAT (₺)	69,21



ÜRÜN KODU	001 052 300002 00 00
ÜRÜN ADI	45x45 UPS.P. ÇEKİRDEĞİ ÇCK. KOR. (45°)
AMB. AD./KOLİ	50/300
FİYAT (₺)	64,46



ÜRÜN KODU	001 052 200003 00 00
ÜRÜN ADI	45x45 PRİZ BİRLEŞTİRME APARATI (YANDAN) (YENİ)
AMB. AD./KOLİ	500/5000
FİYAT (₺)	21,68



ÜRÜN KODU	001 052 200005 00 00
ÜRÜN ADI	45x45 PRİZ BİRLEŞTİRME APARATI
AMB. AD./KOLİ	500/5000
FİYAT (₺)	35,45



ÜRÜN KODU	888 049 050040
ÜRÜN ADI	45x22,5 ANAHTAR
AMB. AD./KOLİ	20/400
FİYAT	2,87 \$



ÜRÜN KODU	888 049 050043
ÜRÜN ADI	45x22,5 VAVİEN
AMB. AD./KOLİ	20/400
FİYAT	3,33 \$



ÜRÜN KODU	888 049 050063
ÜRÜN ADI	45x45 ANAHTAR
AMB. AD./KOLİ	10/200
FİYAT	4,11 \$



ÜRÜN KODU	888 049 050044
ÜRÜN ADI	45x45 YAYLI ÇAĞIRMA (LIGHT)
AMB. AD./KOLİ	10/200
FİYAT	4,11 \$

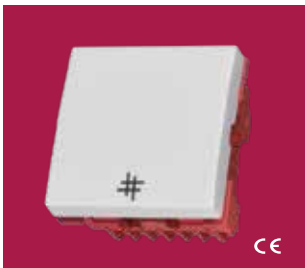

ÜRÜN KODU	888 049 050064
ÜRÜN ADI	45x45 ARA VAVİEN
AMB. AD./KOLİ	10/200
FİYAT	5,64 \$



ÜRÜN KODU	888 049 050065
ÜRÜN ADI	45x45 VAVİEN
AMB. AD./KOLİ	10/200
FİYAT	4,36 \$

KANAL İÇİN UPS VE ENERJİ PRİZLERİ (45x45)



ÜRÜN KODU	888 049 050042
ÜRÜN ADI	45x45 KOMITATÖR
AMB. AD./KOLİ	10/200
FİYAT	5,04 \$



ÜRÜN KODU	888 049 050041
ÜRÜN ADI	45x45 ÇOK AMAÇLI PRİZ
AMB. AD./KOLİ	10/200
FİYAT	5,04 \$



ÜRÜN KODU	888 049 050058
ÜRÜN ADI	45x45 USB 2.0 - AF/AF DATA 90 GİRİŞ
AMB. AD./KOLİ	50/500
FİYAT	2,63 \$



ÜRÜN KODU	888 049 050059
ÜRÜN ADI	45x45 USB 2.0 - AF/AF DATA 180 GİRİŞ
AMB. AD./KOLİ	50/500
FİYAT	2,63 \$

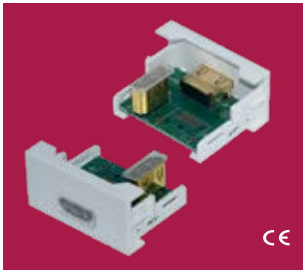

ÜRÜN KODU	888 049 050046
ÜRÜN ADI	45x22,5 HDMI 90 GİRİŞ
AMB. AD./KOLİ	50/500
FİYAT	7,49 \$



ÜRÜN KODU	888 049 050047
ÜRÜN ADI	45x22,5 VGA DATA JACK
AMB. AD./KOLİ	50/500
FİYAT	4,26 \$



ÜRÜN KODU	888 049 050056
ÜRÜN ADI	45x22,5 TV PRİZİ ERKEK
AMB. AD./KOLİ	50/500
FİYAT	1,91 \$



ÜRÜN KODU	888 049 050057
ÜRÜN ADI	45x22,5 TV PRİZİ DIŞI
AMB. AD./KOLİ	50/500
FİYAT	1,99 \$



ÜRÜN KODU	888 049 050049
ÜRÜN ADI	45x22,5 RCA
AMB. AD./KOLİ	50/500
FİYAT	4,69 \$



ÜRÜN KODU	888 049 050060
ÜRÜN ADI	45x22,5 SES JAKI 3,5 mm STEREO
AMB. AD./KOLİ	50/500
FİYAT	2,58 \$



KANAL İÇİN UPS VE ENERJİ PRİZLERİ (45x45)



ÜRÜN KODU	888 049 050051
ÜRÜN ADI	45x22,5 KÖR KAPAK
AMB. AD./KOLİ	100/1000
FİYAT	0,38 \$



ÜRÜN KODU	888 049 050012
ÜRÜN ADI	45x22,5 KEYSTONE JACK PANJURLU KAPAK
AMB. AD./KOLİ	100/1000
FİYAT	0,68 \$



ÜRÜN KODU	888 049 050055
ÜRÜN ADI	45x45 KÖR KAPAK
AMB. AD./KOLİ	100/400
FİYAT	0,69 \$



ÜRÜN KODU	888 049 050013
ÜRÜN ADI	45x45 KEYSTONE JACK PANJURLU KAPAK
AMB. AD./KOLİ	100/500
FİYAT	0,81 \$



ÜRÜN KODU	888 049 050061
ÜRÜN ADI	45x22,5 USB ŞARJ PRİZİ 5V 2,1A
AMB. AD./KOLİ	10/200
FİYAT	18,84 \$



ÜRÜN KODU	888 049 050062
ÜRÜN ADI	45x22,5 U2'Lİ USB ŞARJ PRİZİ 5V 2,1A
AMB. AD./KOLİ	20/200
FİYAT	21,27 \$

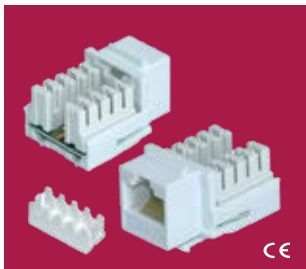

ÜRÜN KODU	888 049 050008
ÜRÜN ADI	DATA KONNEKTÖRÜ CAT 5e (RJ45)
AMB. AD./KOLİ	10/1000
FİYAT	1,7 \$



ÜRÜN KODU	888 049 050032
ÜRÜN ADI	DATA KONNEKTÖRÜ CAT 6e (RJ65 8)
AMB. AD./KOLİ	100/1000
FİYAT	2,22 \$



ÜRÜN KODU	888 049 050009
ÜRÜN ADI	TELEFON KONNEKTÖRÜ (RJ 11/12 6)
AMB. AD./KOLİ	100/1000
FİYAT	1,24 \$

RACK KABİN PRİZ ve AKSESUARLARI



ÜRÜN KODU	075 171 222508
ÜRÜN ADI	16 MODÜL DÖŞEME ALTI PRİZ SİSTEMİ(BOŞ) 270x270
AMB. AD./KOLİ	1/10
FİYAT (₺)	1219,82



ÜRÜN KODU	075 171 333308
ÜRÜN ADI	16 MODÜL DÖŞEME ALTI PRİZ SİSTEMİ BUATI 352x352
AMB. AD./KOLİ	1/5
FİYAT (₺)	1265

KABLO TOPLAMA SİRALI

Ürün Kodu	Ürün Adı	Amb. Birimi	Koli Adedi	Fiyat (\$)
888 020 900003	R1034 16 mm KABLO TOP. SPR. (1,5m VAK)	1 ad.	40	5,06 \$
888 020 900006	R1035 22 mm KABLO TOP. SPR. (1,5m VAK)	1 ad.	40	6,88 \$
888 020 900009	R1036 28 mm KABLO TOP. SPR. (1,5m VAK)	1 ad.	40	8,75 \$
888 020 900004	R1034 16 mm KABLO TOP. SPR. (25 mt.RULO)	1 mt.	150	2,8 \$
888 020 900007	R1035 22 mm KABLO TOP. SPR. (25 mt.RULO)	1 mt.	100	3,91 \$
888 020 900010	R1036 28 mm KABLO TOP. SPR. (25 mt.RULO)	1 mt.	100	5,11 \$
888 020 900011	R1037 34 mm KABLO TOP. SPR. (25 mt.RULO)	1 mt.	50	6,38 \$



KABLO OMURGA KANALI

Ürün Kodu	Ürün Adı	Amb. Birimi	Koli Adedi	Fiyat (₺)
888 020 200801	KABLO OMURGA KANALI - BEYAZ	1 ad.	25	262,04
888 020 200802	KABLO OMURGA KANALI - GRİ	1 ad.	25	262,04
888 020 200803	KABLO OMURGA KANALI - SİYAH	1 ad.	25	275,59

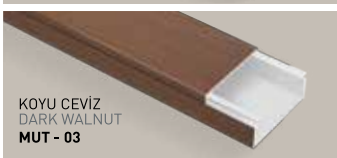
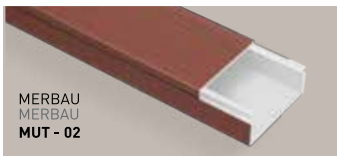
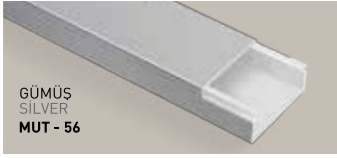
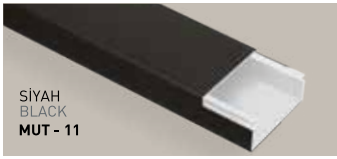

Ürün Kodu	Ürün Adı	Amb. (Kutu)	Amb. Birimi	Fiyat (₺)
SİDEM SERİSİ RENKLİ KABLO KANALLARI				
001 007 010008 20 XX	10X8 MM KABLO KANALI (SİDEM)	330	mt.	45,82
001 007 012012 20 XX	12X12 MM KABLO KANALI (SİDEM)	250	mt.	40,43
001 007 015010 20 XX	15X10 MM KABLO KANALI (SİDEM)	250	mt.	36,11
001 007 016016 20 XX	16X16 MM KABLO KANALI (SİDEM)	250	mt.	50,50
001 007 020010 20 XX	20X10 MM KABLO KANALI (SİDEM)	200	mt.	39,95
001 007 025016 20 XX	25X16 MM KABLO KANALI (SİDEM)	150	mt.	62,31
001 007 025025 20 XX	25X25 MM KABLO KANALI (SİDEM)	100	mt.	81,58
001 007 930010 20 XX	30X10 MM KABLO KANALI (SİDEM) BÖLMELİ	140	mt.	68,34
001 007 930016 20 XX	30X16 MM KABLO KANALI (SİDEM) BÖLMELİ	140	mt.	90,42
001 007 030025 20 XX	30X25 MM KABLO KANALI (SİDEM)	80	mt.	100,20
001 007 040016 20 XX	40X16 MM KABLO KANALI (SİDEM)	100	mt.	81,29
001 007 940016 20 XX	40X16 MM KABLO KANALI (SİDEM)(BÖLMELİ)	100	mt.	97,57
001 007 040025 20 XX	40X25 MM KABLO KANALI (SİDEM)	80	mt.	106,55
001 007 040040 20 XX	40X40 MM KABLO KANALI (SİDEM)	50	mt.	117,99
001 007 960025 20 XX	60X25 MM KABLO KANALI (SİDEM) BÖLMELİ	40	mt.	168,96
001 007 060040 20 XX	60X40 MM KABLO KANALI (SİDEM)	40	mt.	150,90
001 007 060060 20 XX	60X60 MM KABLO KANALI (SİDEM)	32	mt.	234,16
001 007 080040 20 XX	80X40 MM KABLO KANALI (SİDEM)	30	mt.	228,38
001 007 080060 20 XX	80X60 MM KABLO KANALI (SİDEM)	24	mt.	256,75
001 007 100040 20 XX	100X40 MM KABLO KANALI (SİDEM)	24	mt.	284,57
001 007 100048 20 XX	100X48 MM KABLO KANALI (SİDEM)	24	mt.	298,01
001 007 100060 20 XX	100X60 MM KABLO KANALI (SİDEM)	20	mt.	351,95
001 007 075060 20 XX	75X60 MM KABLO KANALI (SİDEM)	30	mt.	258,77
001 007 100037 20 XX	100X37 MM KABLO KANALI (SİDEM) İ.KAPAKLI	30	mt.	300,18
001 007 100050 20 XX	100X50 MM KABLO KANALI (SİDEM) İ.KAPAKLI	20	mt.	312,94
001 007 120060 20 XX	120X60 MM KABLO KANALI (SİDEM) İ.KAPAKLI	16	mt.	431,83
001 007 120070 20 XX	120X70 MM KABLO KANALI (SİDEM)	16	mt.	582,85
001 007 170070 20 XX	170X70 MM KABLO KANALI (SİDEM)	12	mt.	707,48
SİDEM SERİSİ RENKLİ KABLO KANALLARI (YAPIŞKANLI)				
001 155 010008 20 XX	10X8 MM KABLO KANALI (SİDEM) YAPIŞKANLI	330	mt.	45,92
001 155 012012 20 XX	12X12 MM KABLO KANALI (SİDEM) YAPIŞKANLI	250	mt.	42,99
001 155 015010 20 XX	15X10 MM KABLO KANALI (SİDEM) YAPIŞKANLI	250	mt.	43,41
001 155 016016 20 XX	16X16 MM KABLO KANALI (SİDEM) YAPIŞKANLI	240	mt.	52,74
001 155 020010 20 XX	20X10 MM KABLO KANALI (SİDEM) YAPIŞKANLI	180	mt.	43,91
001 155 025016 20 XX	25X16 MM KABLO KANALI (SİDEM) YAPIŞKANLI	150	mt.	65,31
001 155 025025 20 XX	25X25 MM KABLO KANALI (SİDEM) YAPIŞKANLI	100	mt.	86,94
001 155 930010 20 XX	30X10 MM KABLO KANALI (SİDEM) YAPIŞKANLI	140	mt.	61,23
001 155 930016 20 XX	30X16 MM KABLO KANALI (SİDEM) YAPIŞKANLI	140	mt.	78,89
001 155 030025 20 XX	30X25 MM KABLO KANALI (SİDEM) YAPIŞKANLI	80	mt.	102,28
001 155 040016 20 XX	40X16 MM KABLO KANALI (SİDEM) YAPIŞKANLI	100	mt.	129,73
001 155 040025 20 XX	40X25 MM KABLO KANALI (SİDEM) YAPIŞKANLI	80	mt.	119,17
001 155 040040 20 XX	40X40 MM KABLO KANALI (SİDEM) YAPIŞKANLI	50	mt.	129,76
001 155 960025 20 XX	60X25 MM KABLO KANALI (SİDEM) YAPIŞKANLI	40	mt.	182,82
001 155 060040 20 XX	60X40 MM KABLO KANALI (SİDEM) YAPIŞKANLI	40	mt.	176,95
SİDEM SERİSİ SÜPÜRGELİKLER ve AKSESUARLARI				
001 007 974020 20 XX	74X20 MM KABLO KANALI (SİDEM) BÖLMELİ	50	mt.	139,15
001 007 975022 20 XX	75X22 MM KABLO KANALI (SİDEM) BÖLMELİ	50	mt.	208,43
SİDEM SERİSİ BALIK SIRTI ZEMİN KANALLARI ve AKSESUARLARI				
001 007 050013 20 XX	50X13 MM KABLO KANALI (SİDEM)	60	mt.	116,34
001 007 060015 20 XX	60X15 MM KABLO KANALI (SİDEM)	40	mt.	126,75
001 031 060015 00 XX	60X15 MM L KÖŞE(SİDEM)	1	ad.	58,28
001 032 060015 00 XX	60X15 MM EK PARÇA (SİDEM)	1	ad.	35,90
001 033 060015 00 XX	60X15 MM SONLAMA KAPAĞI (SİDEM)	1	ad.	20,72
001 030 060015 00 XX	60X15 MM T KÖŞE (SİDEM)	1	ad.	65,86
001 007 075018 20 XX	75X18 MM KABLO KANALI (SİDEM)	30	mt.	182,06
001 007 090020 20 XX	90X20 MM KABLO KANALI (SİDEM)	20	mt.	267,93
SİDEM SERİSİ BALIK SIRTI ZEMİN KANALLARI (YAPIŞKANLI)				
001 155 050013 20 XX	50X13 MM KABLO KANALI (SİDEM) YAPIŞKANLI	60	mt.	182,85
001 155 060015 20 XX	60X15 MM KABLO KANALI (SİDEM) YAPIŞKANLI	40	mt.	198,12
001 155 075018 20 XX	75X18 MM KABLO KANALI (SİDEM) YAPIŞKANLI	30	mt.	210,01
12x12 KANAL AKSESUARLARI - SİDEM SERİSİ				
001 028 012012 00 XX	12X12 MM (SİDEM) İÇ KÖŞE	1	ad.	30,56
001 029 012012 00 XX	12X12 MM (SİDEM) DIŞ KÖŞE	1	ad.	30,57
001 030 012012 00 XX	12X12 MM (SİDEM) T KÖŞE	1	ad.	30,14
001 031 012012 00 XX	12X12 MM (SİDEM) 90 L KÖŞE	1	ad.	30,14
001 033 012012 00 XX	12X12 MM (SİDEM) UÇ TAPA	1	ad.	20,46
001 032 012012 00 XX	12X12 MM (SİDEM) EK PARÇASI	1	ad.	20,46
15x10 KANAL AKSESUARLARI - SİDEM SERİSİ				
001 028 015010 00 XX	15X10 MM (SİDEM) İÇ KÖŞE	1	ad.	19,69
001 029 015010 00 XX	15X10 MM (SİDEM) DIŞ KÖŞE	1	ad.	19,68
001 030 015010 00 XX	15X10 MM (SİDEM) T KÖŞE	1	ad.	29,71
001 031 015010 00 XX	15X10 MM (SİDEM) 90 L KÖŞE	1	ad.	29,71
001 033 015010 00 XX	15X10 MM (SİDEM) UÇ TAPA	1	ad.	17,39
001 032 015010 00 XX	15X10 MM (SİDEM) EK PARÇASI	1	ad.	17,39

Ürün Kodu	Ürün Adı	Amb. (Kutu)	Amb. Birimi	Fiyat (₺)
16x16 KANAL AKSESUARLARI - SİDEM SERİSİ				€ €
001 028 016016 00 XX	16x16 MM (SİDEM) İÇ KÖŞE	1	ad.	18,89
001 029 016016 00 XX	16x16 MM (SİDEM) DIŞ KÖŞE	1	ad.	18,89
001 030 016016 00 XX	16x16 MM (SİDEM) T KÖŞE	1	ad.	35,82
001 031 016016 00 XX	16x16 MM (SİDEM) 90 L KÖŞE	1	ad.	35,82
001 033 016016 00 XX	16x16 MM (SİDEM) UÇ TAPA	1	ad.	17,82
001 032 016016 00 XX	16x16 MM (SİDEM) EK PARÇASI	1	ad.	17,82
20x10 KANAL AKSESUARLARI - SİDEM SERİSİ				€ €
001 028 020010 00 XX	20x10 MM (SİDEM) İÇ KÖŞE	1	ad.	28,21
001 029 020010 00 XX	20x10 MM (SİDEM) DIŞ KÖŞE	1	ad.	28,21
001 030 020010 00 XX	20x10 MM (SİDEM) T KÖŞE	1	ad.	29,50
001 031 020010 00 XX	20x10 MM (SİDEM) 90 L KÖŞE	1	ad.	29,50
001 033 020010 00 XX	20x10 MM (SİDEM) UÇ TAPA	1	ad.	20,00
001 032 020010 00 XX	20x10 MM (SİDEM) EK PARÇASI	1	ad.	20,00
TAVAN KÖŞE KANALI (23x23) AKSESUARLARI -SİDEM SERİSİ				€ €
001 041 023023 00 XX	23X23 MM T PARÇASI	1	ad.	80,44
001 042 023023 00 XX	23X23 MM 90 L KÖŞE	1	ad.	80,44
001 043 023023 00 XX	23X23 MM EK PARÇA	1	ad.	20,92
001 044 023023 00 XX	23X23 MM UÇ TAPA	1	ad.	20,92
25x16 KANAL AKSESUARLARI - SİDEM SERİSİ				€ €
001 028 025016 00 XX	25X16 MM (SİDEM) İÇ KÖŞE	1	ad.	37,64
001 029 025016 00 XX	25X16 MM (SİDEM) DIŞ KÖŞE	1	ad.	37,64
001 030 025016 00 XX	25X16 MM (SİDEM) T KÖŞE	1	ad.	40,46
001 031 025016 00 XX	25X16 MM (SİDEM) 90 L KÖŞE	1	ad.	40,48
001 033 025016 00 XX	25X16 MM (SİDEM) UÇ TAPA	1	ad.	24,68
001 032 025016 00 XX	25X16 MM (SİDEM) EK PARÇA	1	ad.	24,68
001 034 017421 00 XX	25X16 MM (SİDEM) PMK (45X45)	1	ad.	378,30
25x25 KANAL AKSESUARLARI - SİDEM SERİSİ				€ €
001 028 025025 00 XX	25x25 MM (SİDEM) İÇ KÖŞE	1	ad.	28,33
001 029 025025 00 XX	25x25 MM (SİDEM) DIŞ KÖŞE	1	ad.	28,32
001 030 025025 00 XX	25x25 MM (SİDEM) T PARÇASI	1	ad.	37,96
001 031 025025 00 XX	25x25 MM (SİDEM) 90 L KÖŞE	1	ad.	37,96
001 033 025025 00 XX	25x25 MM (SİDEM) UÇ TAPA	1	ad.	20,54
001 032 025025 00XX	25x25 MM (SİDEM) EK PARÇA	1	ad.	20,54
001 034 017421 00 XX	25x25 MM (SİDEM) PMK (45X45)	1	ad.	378,30
30x10 KANAL AKSESUARLARI - SİDEM SERİSİ				€ €
001 028 030010 00 XX	30X10 MM (SİDEM) İÇ KÖŞE	1	ad.	37,73
001 029 030010 00 XX	30X10 MM (SİDEM) DIŞ KÖŞE	1	ad.	37,71
001 030 030010 00 XX	30X10 MM (SİDEM) T PARÇASI	1	ad.	47,68
001 031 030010 00 XX	30X10 MM (SİDEM) 90 L KÖŞE	1	ad.	47,68
001 033 030010 00 XX	30X10 MM (SİDEM) UÇ TAPA	1	ad.	22,14
001 032 030010 00 XX	30X10 MM (SİDEM) EK PARÇA	1	ad.	22,14
30x16 KANAL AKSESUARLARI - SİDEM SERİSİ				€ €
001 028 030016 00 XX	30x16 MM (SİDEM) İÇ KÖŞE	1	ad.	43,54
001 029 030016 00 XX	30x16 MM (SİDEM) DIŞ KÖŞE	1	ad.	43,54
001 030 030016 00 XX	30x16 MM (SİDEM) T PARÇASI	1	ad.	58,57
001 031 030016 00 XX	30x16 MM (SİDEM) 90 L KÖŞE	1	ad.	58,57
001 033 030016 00 XX	30x16 MM (SİDEM) UÇ TAPA	1	ad.	24,64
001 032 030016 00 XX	30x16 MM (SİDEM) EK PARÇA	1	ad.	24,64
30x25 KANAL AKSESUARLARI - SİDEM SERİSİ				€ €
001 028 030025 00 XX	30X25 MM (SİDEM) İÇ KÖŞE	1	ad.	42,43
001 029 030025 00 XX	30X25 MM (SİDEM) DIŞ KÖŞE	1	ad.	42,43
001 030 030025 00 XX	30X25 MM (SİDEM) T PARÇASI	1	ad.	59,29
001 031 030025 00 XX	30X25 MM (SİDEM) 90 L KÖŞE	1	ad.	59,29
001 033 030025 00 XX	30X25 MM (SİDEM) UÇ TAPA	1	ad.	25,86
001 032 030025 00 XX	30X25 MM (SİDEM) EK PARÇA	1	ad.	25,86
40x16 KANAL AKSESUARLARI - SİDEM SERİSİ				€ €
001 028 040016 00 XX	40x16 MM (SİDEM) İÇ KÖŞE	1	ad.	44,93
001 029 040016 00 XX	40x16 MM (SİDEM) DIŞ KÖŞE	1	ad.	44,93
001 030 040016 00 XX	40x16 MM (SİDEM) T PARÇASI	1	ad.	62,50
001 031 040016 00 XX	40x16 MM (SİDEM) 90 L KÖŞE	1	ad.	62,50
001 033 040016 00 XX	40x16 MM (SİDEM) UÇ TAPA	1	ad.	31,57
001 032 040016 00 XX	40x16 MM (SİDEM) EK PARÇA	1	ad.	31,58
001 034 017421 00 XX	40X16 MM (SİDEM) PMK (45X45)	1	ad.	378,30
40x25 KANAL AKSESUARLARI - SİDEM SERİSİ				€ €
001 028 040025 00 XX	40X25 MM (SİDEM) İÇ KÖŞE	1	ad.	52,04
001 029 040025 00 XX	40X25 MM (SİDEM) DIŞ KÖŞE	1	ad.	52,04
001 030 040025 00 XX	40X25 MM (SİDEM) T KÖŞE	1	ad.	65,00
001 031 040025 00 XX	40X25 MM (SİDEM) 90 L KÖŞE	1	ad.	65,00
001 033 040025 00 XX	40X25 MM (SİDEM) UÇ TAPA	1	ad.	34,75
001 032 040025 00 XX	40X25 MM (SİDEM) EK PARÇASI	1	ad.	34,75
001 034 017421 00 XX	40X25 MM (SİDEM) PMK (45X45)	1	ad.	378,30



L KÖŞE



EK PARÇA



UÇ TAPA





İÇ KÖŞE



DIŞ KÖŞE



T KÖŞE



L KÖŞE



EK PARÇA



UÇ TAPA

Ürün Kodu	Ürün Adı	Amb. (Kutu)	Amb. Birimi	Fiyat (₺)
40x40 KANAL AKSESUARLARI - SİDEM SERİSİ				
€ €				
001 028 040040 00 XX	40x40 MM (SİDEM) İÇ KÖŞE	1	ad.	55,00
001 029 040040 00 XX	40x40 MM (SİDEM) DIŞ KÖŞE	1	ad.	55,00
001 030 040040 00 XX	40x40 MM (SİDEM) T KÖŞE	1	ad.	57,71
001 031 040040 00 XX	40x40 MM (SİDEM) 90 L KÖŞE	1	ad.	57,70
001 033 040040 00 XX	40x40 MM (SİDEM) UÇ TAPA	1	ad.	41,89
001 032 040040 00 XX	40x40 MM (SİDEM) EK PARÇASI	1	ad.	41,89
001 034 017421 00 XX	40x40 MM (SİDEM) PMK (45X45)	1	ad.	378,30
60x25 KANAL AKSESUARLARI - SİDEM SERİSİ				
€ €				
001 028 060025 00 XX	60x25 MM (SİDEM) İÇ KÖŞE	1	ad.	57,86
001 029 060025 00 XX	60x25 MM (SİDEM) DIŞ KÖŞE	1	ad.	57,86
001 030 060025 00 XX	60x25 MM (SİDEM) T KÖŞE	1	ad.	62,32
001 031 060025 00 XX	60x25 MM (SİDEM) 90 L KÖŞE	1	ad.	62,32
001 033 060025 00 XX	60x25 MM (SİDEM) UÇ TAPA	1	ad.	42,14
001 032 060025 00 XX	60x25 MM (SİDEM) EK PARÇASI	1	ad.	42,14
60x40 KANAL AKSESUARLARI - SİDEM SERİSİ				
€ €				
001 028 060040 00 XX	60x40 MM (SİDEM) İÇ KÖŞE	1	ad.	58,57
001 029 060040 00 XX	60x40 MM (SİDEM) DIŞ KÖŞE	1	ad.	58,57
001 030 060040 00 XX	60x40 MM (SİDEM) T KÖŞE	1	ad.	61,43
001 031 060040 00 XX	60x40 MM (SİDEM) 90 L KÖŞE	1	ad.	61,43
001 033 060040 00 XX	60x40 MM (SİDEM) UÇ TAPA	1	ad.	42,75
001 032 060040 00 XX	60x40 MM (SİDEM) EK PARÇA	1	ad.	42,75
60x60 KANAL AKSESUARLARI - SİDEM SERİSİ				
€ €				
001 028 060060 00 XX	60x60 MM (SİDEM) İÇ KÖŞE	1	ad.	72,79
001 029 060060 00 XX	60x60 MM (SİDEM) DIŞ KÖŞE	1	ad.	72,79
001 030 060060 00 XX	60x60 MM (SİDEM) T PARÇASI	1	ad.	83,79
001 031 060060 00 XX	60x60 MM (SİDEM) 90 L KÖŞE	1	ad.	83,79
001 033 060060 00 XX	60x60 MM (SİDEM) UÇ TAPA	1	ad.	49,93
001 032 060060 00 XX	60x60 MM (SİDEM) EK PARÇA	1	ad.	49,93
74x20 KANAL AKSESUARLARI - SİDEM SERİSİ				
€ €				
001 028 074020 00 XX	74x20 MM (SİDEM) İÇ KÖŞE	1	ad.	60,64
001 029 074020 00 XX	74x20 MM (SİDEM) DIŞ KÖŞE	1	ad.	60,64
001 030 074020 00 XX	74x20 MM (SİDEM) T PARÇASI	1	ad.	63,25
001 031 074020 00 XX	74x20 MM (SİDEM) 90 L KÖŞE	1	ad.	63,24
001 032 074020 00 XX	74x20 MM (SİDEM) UÇ TAPA	1	ad.	57,43
001 033 074020 00 XX	74x20 MM (SİDEM) EK PARÇA	1	ad.	57,43
001 036 017420 00 XX	74x20 MM (SİDEM) PRİZ MONTAJ KASASI	1	ad.	620,97
75x22 KANAL AKSESUARLARI - SİDEM SERİSİ				
€ €				
001 028 075022 00 XX	75x22 MM (SİDEM) İÇ KÖŞE	1	ad.	55,89
001 029 075022 00 XX	75x22 MM (SİDEM) DIŞ KÖŞE	1	ad.	55,89
001 033 075022 01 XX	75x22 MM (SİDEM) SAĞ SONLAMA	1	ad.	76,57
001 033 075022 02 XX	75x22 MM (SİDEM) SOL SONLAMA	1	ad.	76,57
001 032 075022 00 XX	75x22 MM (SİDEM) EK PARÇASI	1	ad.	50,71
80x40 KANAL AKSESUARLARI - SİDEM SERİSİ				
€ €				
001 028 080040 00 XX	80x40 MM (SİDEM) İÇ KÖŞE	1	ad.	71,36
001 029 080040 00 XX	80x40 MM (SİDEM) DIŞ KÖŞE	1	ad.	71,36
001 030 080040 00 XX	80x40 MM (SİDEM) T PARÇASI	1	ad.	78,04
001 031 080040 00 XX	80x40 MM (SİDEM) 90 L KÖŞE	1	ad.	78,04
001 033 080040 00 XX	80x40 MM (SİDEM) UÇ TAPA	1	ad.	65,89
001 032 080040 00 XX	80x40 MM (SİDEM) EK PARÇA	1	ad.	65,89
80x60 KANAL AKSESUARLARI - SİDEM SERİSİ				
€ €				
001 028 080060 00 XX	80x60 MM (SİDEM) İÇ KÖŞE	1	ad.	92,93
001 029 080060 00 XX	80x60 MM (SİDEM) DIŞ KÖŞE	1	ad.	92,93
001 030 080060 00 XX	80x60 MM (SİDEM) T PARÇASI	1	ad.	81,29
001 031 080060 00 XX	80x60 MM (SİDEM) 90 L KÖŞE	1	ad.	81,29
001 033 080060 00 XX	80x60 MM (SİDEM) UÇ TAPA	1	ad.	58,39
001 032 080060 00 XX	80x60 MM (SİDEM) EK PARÇA	1	ad.	58,39

Ürün Kodu	Ürün Adı	Amb. (Kutu)	Amb. Birimi	Fiyat (₺)
100x37 KANAL AKSESUARLARI - SİDEM SERİSİ				€ €
001 028 100037 00 XX	100X37 MM (SİDEM) İÇ KÖŞE (SABİT)	1	ad.	114,63
001 029 100037 00 XX	100X37 MM (SİDEM) DIŞ KÖŞE (SABİT)	1	ad.	114,64
001 028 100037 01 XX	100X37 MM (SİDEM) İÇ KÖŞE (HAREKETLİ)	1	ad.	114,64
001 029 100037 01 XX	100X37 MM (SİDEM) DIŞ KÖŞE (HAREKETLİ)	1	ad.	114,64
001 030 100037 00 XX	100X37 MM (SİDEM) T PARÇASI	1	ad.	122,14
001 031 100037 00 XX	100X37 MM (SİDEM) 90 L KÖŞE	1	ad.	122,14
001 033 100037 00 XX	100X37 MM (SİDEM) UÇ TAPA	1	ad.	80,00
001 032 100037 00 XX	100X37 MM (SİDEM) EK PARÇA	1	ad.	80,00
100x40 KANAL AKSESUARLARI - SİDEM SERİSİ				€ €
001 028 100040 00 XX	100X40 MM (SİDEM) İÇ KÖŞE (SABİT)	1	ad.	119,54
001 029 100040 00 XX	100X40 MM (SİDEM) DIŞ KÖŞE (SABİT)	1	ad.	119,54
001 028 100040 01 XX	100X40 MM (SİDEM) İÇ KÖŞE (HAREKETLİ)	1	ad.	119,54
001 029 100040 01 XX	100X40 MM (SİDEM) DIŞ KÖŞE (HAREKETLİ)	1	ad.	119,54
001 030 100040 00 XX	100X40 MM (SİDEM) T PARÇASI	1	ad.	124,29
001 031 100040 00 XX	100X40 MM (SİDEM) 90 L KÖŞE	1	ad.	124,29
001 033 100040 00 XX	100X40 MM (SİDEM) UÇ TAPA	1	ad.	81,32
001 032 100040 00 XX	100X40 MM (SİDEM) EK PARÇA	1	ad.	81,32
100x48 KANAL AKSESUARLARI - SİDEM SERİSİ				€ €
001 028 100048 00 XX	100X48 MM (SİDEM) İÇ KÖŞE (SABİT)	1	ad.	129,11
001 029 100048 00 XX	100X48 MM (SİDEM) DIŞ KÖŞE (SABİT)	1	ad.	129,11
001 028 100048 01 XX	100X48 MM (SİDEM) İÇ KÖŞE (HAREKETLİ)	1	ad.	129,11
001 029 100048 01 XX	100X48 MM (SİDEM) DIŞ KÖŞE (HAREKETLİ)	1	ad.	129,11
001 030 100048 00 XX	100X48 MM (SİDEM) T PARÇASI	1	ad.	133,57
001 031 100048 00 XX	100X48 MM (SİDEM) 90 L KÖŞE	1	ad.	133,57
001 033 100048 00 XX	100X48 MM (SİDEM) UÇ TAPA	1	ad.	86,43
001 032 100048 00 XX	100X48 MM (SİDEM) EK PARÇA	1	ad.	86,43
100x50 KANAL AKSESUARLARI - SİDEM SERİSİ				€ €
001 028 100050 00 XX	100X50 MM (SİDEM) İÇ KÖŞE (SABİT)	1	ad.	137,61
001 029 100050 00 XX	100X50 MM (SİDEM) DIŞ KÖŞE (SABİT)	1	ad.	137,61
001 028 100050 01 XX	100X50 MM (SİDEM) İÇ KÖŞE (HAREKETLİ)	1	ad.	137,61
001 029 100050 01 XX	100X50 MM (SİDEM) DIŞ KÖŞE (HAREKETLİ)	1	ad.	137,61
001 030 100050 00 XX	100X50 MM (SİDEM) T PARÇASI	1	ad.	140,71
001 031 100050 00 XX	100X50 MM (SİDEM) 90 L KÖŞE	1	ad.	140,71
001 033 100050 00 XX	100X50 MM (SİDEM) UÇ TAPA	1	ad.	91,43
001 032 100050 00 XX	100X50 MM (SİDEM) EK PARÇA	1	ad.	91,43
100x60 KANAL AKSESUARLARI - SİDEM SERİSİ				€ €
001 028 100060 00 XX	100X60 MM (SİDEM) İÇ KÖŞE (SABİT)	1	ad.	155,36
001 029 100060 00 XX	100X60 MM (SİDEM) DIŞ KÖŞE (SABİT)	1	ad.	155,36
001 028 100060 01 XX	100X60 MM (SİDEM) İÇ KÖŞE (HAREKETLİ)	1	ad.	155,36
001 029 100060 01 XX	100X60 MM (SİDEM) DIŞ KÖŞE (HAREKETLİ)	1	ad.	155,36
001 030 100060 00 XX	100X60 MM (SİDEM) T PARÇASI	1	ad.	169,21
001 031 100060 00 XX	100X60 MM (SİDEM) 90 L KÖŞE	1	ad.	169,21
001 033 100060 00 XX	100X60 MM (SİDEM) UÇ TAPA	1	ad.	100,21
001 032 100060 00 XX	100X60 MM (SİDEM) EK PARÇA	1	ad.	100,21
İÇTEN KAPAKLI 100x37/50 İÇİN PMS - SİDEM SERİSİ				€ €
001 034 400001 00 XX	100X37/50 (SİDEM) 45X45 PMS TEKLİ	1	ad.	76,01
001 034 400002 00 XX	100X37/50 (SİDEM) 45X45 PMS İKİLİ	1	ad.	81,07
001 034 400003 00 XX	100X37/50 (SİDEM) 45X45 PMS ÜÇLÜ	1	ad.	85,15
001 034 400004 00 XX	100X37/50 (SİDEM) 45X45 PMS DÖRTLÜ	1	ad.	128,89
001 034 500001 00 XX	100X37/50 (SİDEM) 55X55 PMS TEKLİ	1	ad.	108,75
001 034 500002 00 XX	100X37/50 (SİDEM) 55X55 PMS İKİLİ	1	ad.	125,30
001 034 500003 00 XX	100X37/50 (SİDEM) 55X55 PMS ÜÇLÜ	1	ad.	135,71
DIŞTAN KAPAKLI 100'LÜK PMS 55x55 İÇİN - SİDEM SERİSİ				€ €
001 034 000001 00 XX	100'LÜK 55X55 PMS TEKLİ SİDEM	1	ad.	141,67
001 034 000002 00 XX	100'LÜK 55X55 PMS İKİLİ SİDEM	1	ad.	173,01
001 034 000003 00 XX	100'LÜK 55X55 PMS ÜÇLÜ SİDEM	1	ad.	196,34
DIŞTAN KAPAKLI 100'LÜK PMS 45x45 İÇİN - SİDEM SERİSİ				€ €
001 034 100001 00 XX	100'LÜK 45X45 PMS TEKLİ SİDEM	1	ad.	91,51
001 034 100002 00 XX	100'LÜK 45X45 PMS İKİLİ SİDEM	1	ad.	117,18
001 034 100003 00 XX	100'LÜK 45X45 PMS ÜÇLÜ SİDEM	1	ad.	166,85
001 034 100004 00 XX	100'LÜK 45X45 PMS DÖRTLÜ SİDEM	1	ad.	177,04



İÇ KÖŞE



DIŞ KÖŞE



T KÖŞE



L KÖŞE





Sıva altı serisinde **betopan, alçıpan** duvarlara montaj yapılabilme özelliği.



Ürün Kodu	Ürün Adı	Kutu Adet	Koli Adet	Normal Fiyat (₺)	Kutusuz Fiyat (₺)
COMFORT W OTOMAT KUTULARI					
IP40					
001 057 200001 00 00	COMFORT MÜH. SİGORTA KUTUSU(S/Ü) 1 Lİ	20	120	19,09	-
001 057 200002 00 00	COMFORT MÜH. SİGORTA KUTUSU(S/Ü) 1-2 Lİ	20	80	23,42	-
001 057 200004 00 00	COMFORT MÜH. SİGORTA KUTUSU(S/Ü) 2-4 Lİ	10	60	34,26	-
001 057 100006 00 00	COMFORT SİGORTA KUTUSU (S/Ü) 6 Lİ	1	20	183,06	151,58
001 057 100009 00 00	COMFORT SİGORTA KUTUSU (S/Ü) 9 LU	1	20	226,59	194,10
001 057 100012 00 00	COMFORT SİGORTA KUTUSU (S/Ü) 12 Lİ	1	10	272,45	236,06
001 057 100018 00 00	COMFORT SİGORTA KUTUSU (S/Ü) 18 Lİ	1	10	382,71	329,12
001 057 100024 00 00	COMFORT SİGORTA KUTUSU (S/Ü) 24 LÜ	1	5	487,96	416,36
001 057 100036 00 00	COMFORT SİGORTA KUTUSU (S/Ü) 36 Lİ	1	5	628,15	546,53
001 057 000006 00 00	COMFORT SİGORTA KUTUSU (S/A) 6 Lİ	1	20	181,18	149,70
001 057 000009 00 00	COMFORT SİGORTA KUTUSU (S/A) 9 LU	1	20	225,93	193,97
001 057 000012 00 00	COMFORT SİGORTA KUTUSU (S/A) 12 Lİ	1	10	272,47	234,01
001 057 000018 00 00	COMFORT SİGORTA KUTUSU (S/A) 18 Lİ	1	10	373,36	319,77
001 057 000024 00 00	COMFORT SİGORTA KUTUSU (S/A) 24 LÜ	1	5	471,92	403,36
001 057 000036 00 00	COMFORT SİGORTA KUTUSU (S/A) 36 Lİ	1	5	637,61	555,63
COMFORT W OTOMAT KUTULARI - ALEV YAYMAYAN					
IP40					
001 057 210001 00 00	COMFORT MÜH. SİGORTA (A.YAYMAYAN)(S/Ü) 1 Lİ	20	120	49,93	-
001 057 210002 00 00	COMFORT MÜH. SİGORTA (A.YAYMAYAN)(S/Ü) 1-2 Lİ	20	80	59,71	-
001 057 210004 00 00	COMFORT MÜH. SİGORTA (A.YAYMAYAN)(S/Ü) 2-4 LÜ	10	60	72,91	-
001 057 110006 00 00	COMFORT SİGORTA KUTUSU(S/Ü)(A.YAYMAYAN) 6 Lİ	1	20	315,19	-
001 057 110009 00 00	COMFORT SİGORTA KUTUSU(S/Ü)(A.YAYMAYAN) 9 LU	1	20	360,47	-
001 057 110012 00 00	COMFORT SİGORTA KUTUSU(S/Ü)(A.YAYMAYAN) 12 Lİ	1	10	492,82	-
001 057 110018 00 00	COMFORT SİGORTA KUTUSU(S/Ü)(A.YAYMAYAN) 18 Lİ	1	10	730,19	-
001 057 110024 00 00	COMFORT SİGORTA KUTUSU(S/Ü)(A.YAYMAYAN) 24 LÜ	1	5	801,73	-
001 057 110036 00 00	COMFORT SİGORTA KUTUSU(S/Ü)(A.YAYMAYAN) 36 Lİ	1	5	978,46	-
001 057 010006 00 00	COMFORT SİGORTA KUTUSU(S/A) A.YAYMAYAN 6 Lİ	1	20	282,54	-
001 057 010009 00 00	COMFORT SİGORTA KUTUSU(S/A) A.YAYMAYAN 9 LU	1	20	343,84	-
001 057 010012 00 00	COMFORT SİGORTA KUTUSU(S/A) A.YAYMAYAN 12 Lİ	1	10	481,92	-
001 057 010018 00 00	COMFORT SİGORTA KUTUSU(S/A) A.YAYMAYAN 18 Lİ	1	10	684,48	-
001 057 010024 00 00	COMFORT SİGORTA KUTUSU(S/A) A.YAYMAYAN 24 LÜ	1	5	750,87	-
001 057 010036 00 00	COMFORT SİGORTA KUTUSU(S/A) A.YAYMAYAN 36 Lİ	1	5	924,9	-
COMFORT W OTOMAT KUTULARI - HALOJEN FREE - ALEV YAYAN					
IP40					
001 057 220001 00 00	COMFORT MÜH. SİGORTA KUTUSU H.FREE (ALEV YAYAN)(S/Ü)1 Lİ	20	120	27,32	-
001 057 220002 00 00	COMFORT MÜH. SİGORTA KUTUSU H.FREE (ALEV YAYAN)(S/Ü)1-2 Lİ	20	80	34,25	-
001 057 220004 00 00	COMFORT MÜH. SİGORTA KUTUSU H.FREE (ALEV YAYAN)(S/Ü)2-4 Lİ	10	60	44,07	-
001 057 120006 00 00	COMFORT SİGORTA KUTUSU H.FREE (ALEV YAYAN) (S/Ü) 6 Lİ	1	20	199,89	-
001 057 120009 00 00	COMFORT SİGORTA KUTUSU H.FREE (ALEV YAYAN) (S/Ü) 9 LU	1	20	227,09	-
001 057 120012 00 00	COMFORT SİGORTA KUTUSU H.FREE (ALEV YAYAN) (S/Ü) 12 Lİ	1	10	291,22	-
001 057 120018 00 00	COMFORT SİGORTA KUTUSU H.FREE (ALEV YAYAN) (S/Ü) 18 Lİ	1	10	432,8	-
001 057 120024 00 00	COMFORT SİGORTA KUTUSU H.FREE (ALEV YAYAN) (S/Ü) 24 LÜ	1	5	552,82	-
001 057 120036 00 00	COMFORT SİGORTA KUTUSU H.FREE (ALEV YAYAN) (S/Ü) 36 Lİ	1	5	611,18	-
001 057 020006 00 00	COMFORT SİGORTA KUTUSU H.FREE (ALEV YAYAN) (S/A) 6 Lİ	1	20	194,55	-
001 057 020009 00 00	COMFORT SİGORTA KUTUSU H.FREE (ALEV YAYAN) (S/A) 9 LU	1	20	228,54	-
001 057 020012 00 00	COMFORT SİGORTA KUTUSU H.FREE (ALEV YAYAN) (S/A) 12 Lİ	1	10	308,6	-
001 057 020018 00 00	COMFORT SİGORTA KUTUSU H.FREE (ALEV YAYAN) (S/A) 18 Lİ	1	10	425,22	-
001 057 020024 00 00	COMFORT SİGORTA KUTUSU H.FREE (ALEV YAYAN) (S/A) 24 LÜ	1	5	556,48	-
001 057 020036 00 00	COMFORT SİGORTA KUTUSU H.FREE (ALEV YAYAN) (S/A) 36 Lİ	1	5	616,24	-
COMFORT W OTOMAT ZAYIF AKIM KUTULARI					
IP40					
001 057 101012 00 00	COMFORT ZAYIF AKIM KUTUSU (S/Ü)(225x270)	1	10	251,32	-
001 057 101020 00 00	COMFORT ZAYIF AKIM KUTUSU (S/Ü)(270x340)	1	5	434,66	-
001 057 101024 00 00	COMFORT 12 Lİ SİGORTA + ZAYIF AKIM KUTUSU (S/Ü)	1	5	453,1	-
001 057 101036 00 00	COMFORT 24 LÜ SİGORTA + ZAYIF AKIM KUTUSU (S/Ü)	1	5	572,24	-
001 057 001012 00 00	COMFORT ZAYIF AKIM KUTUSU (S/A)(205x250)	1	10	246,87	-
001 057 001020 00 00	COMFORT ZAYIF AKIM KUTUSU (S/A)(243x318)	1	5	431,78	-
001 057 001024 00 00	COMFORT 12 Lİ SİGORTA + ZAYIF AKIM KUTUSU (S/A)	1	5	449,03	-
001 057 001036 00 00	COMFORT 24 LÜ SİGORTA + ZAYIF AKIM KUTUSU (S/A)	1	5	575,19	-
COMFORT W OTOMAT ZAYIF AKIM KUTULARI - HALOJEN FREE - ALEV YAYAN					
IP40					
001 057 121012 00 00	COMFORT ZAYIF AKIM KUTUSU H.FREE (ALEV YAYAN) (S/Ü)(225x270)	1	10	286,62	-
001 057 121020 00 00	COMFORT ZAYIF AKIM KUTUSU H.FREE (ALEV YAYAN) (S/Ü)(270x340)	1	5	502,62	-
001 057 121024 00 00	COMFORT 12 Lİ SİGORTA + ZAYIF AKIM KUTUSU H.FREE (ALEV YAYAN) (S/Ü)	1	5	526,13	-
001 057 121036 00 00	COMFORT 24 LÜ SİGORTA + ZAYIF AKIM KUTUSU H.FREE (ALEV YAYAN) (S/Ü)	1	5	628,95	-
001 057 021012 00 00	COMFORT ZAYIF AKIM KUTUSU H.FREE (ALEV YAYAN) (S/A)(205x250)	1	10	293,24	-
001 057 021020 00 00	COMFORT ZAYIF AKIM KUTUSU H.FREE (ALEV YAYAN) (S/A)(243x318)	1	5	451,79	-
001 057 021024 00 00	COMFORT 12 Lİ SİGORTA + ZAYIF AKIM KUTUSU H.FREE (ALEV YAYAN) (S/A)	1	5	516,45	-
001 057 021036 00 00	COMFORT 24 LÜ SİGORTA + ZAYIF AKIM KUTUSU H.FREE (ALEV YAYAN) (S/A)	1	5	630,5	-
COMFORT W OTOMAT ZAYIF AKIM KUTULARI - ALEV YAYMAYAN					
IP40					
001 057 111012 00 00	COMFORT ZAYIF AKIM KUTUSU(A.YAYMAYAN)(S/Ü)(225x270)	1	10	421,86	-
001 057 111020 00 00	COMFORT ZAYIF AKIM KUTUSU(A.YAYMAYAN)(S/Ü)(270x340)	1	5	718,37	-
001 057 111024 00 00	COMFORT 12 Lİ SİGORTA + ZAYIF AKIM KUTUSU(A.YAYMAYAN)(S/Ü)	1	5	695,91	-
001 057 111036 00 00	COMFORT 24 LÜ SİGORTA + ZAYIF AKIM KUTUSU(A.YAYMAYAN)(S/Ü)	1	5	882,2	-
001 057 011012 00 00	COMFORT ZAYIF AKIM KUTUSU(A.YAYMAYAN)(S/A)(205x250)	1	10	413,88	-
001 057 011020 00 00	COMFORT ZAYIF AKIM KUTUSU(A.YAYMAYAN)(S/A)(243x318)	1	5	678,87	-
001 057 011024 00 00	COMFORT 12 Lİ SİGORTA + ZAYIF AKIM KUTUSU(A.YAYMAYAN)(S/A)	1	5	655,98	-
001 057 011036 00 00	COMFORT 24 LÜ SİGORTA + ZAYIF AKIM KUTUSU(A.YAYMAYAN)(S/A)	1	5	845,66	-
COMFORT W OTOMAT KUTUSU AKSESUARLARI					
001 057 990001 00 00	S/A COMFORT ALÇIPAN MONTAJ SETİ	1		22,31	-
001 057 990002 00 00	COMFORT SU TERAZİSİ	1		36,6	-
000 700 000574 00 00	RAY YÜKSELTME PARÇASI (UZUN/KISA)	1		4,43	-
001 057 001236 00 00	COMFORT ZAYIF AKIM ÖRTME PARÇASI	50		25,4	-

Ürün Kodu	Ürün Adı	Kutu Adet	Koli Adet	Kutu Fiyat (₺)
W OTOMAT ÖRTME PARÇALARI				
001 026 000002 00 00	W OTOMAT ÖRTME PARÇASI 12'Lİ - YENİ TİP	50	400	17,76
MEKSBOX W OTOMAT KUTULARI				
IP30				
001 027 200001 00 00	MÜHÜRLÜ W OTOMAT KUTUSU (S/Ü) 1 Lİ	20	160	17,12
001 027 200002 00 00	MÜHÜRLÜ W OTOMAT KUTUSU (S/Ü) 2 Lİ	20	80	19,73
001 027 200004 00 00	MÜHÜRLÜ W OTOMAT KUTUSU (S/Ü) 4 LÜ	10	80	33,57
001 027 100002 00 00	W OTOMAT KUTUSU (S/Ü) MEKSBOX 2 Lİ	1	30	152,13
001 027 000002 00 00	W OTOMAT KUTUSU (S/A) MEKSBOX 2 Lİ	1	30	145,53
001 027 100004 00 00	W OTOMAT KUTUSU (S/Ü) MEKSBOX 4 LÜ	1	20	157,03
001 027 000004 00 00	W OTOMAT KUTUSU (S/A) MEKSBOX 4 LÜ	1	20	149,57
001 027 100006 00 00	W OTOMAT KUTUSU (S/Ü) MEKSBOX 6 Lİ	1	20	179,56
001 027 000006 00 00	W OTOMAT KUTUSU (S/A) MEKSBOX 6 Lİ	1	20	180,35
001 027 100009 00 00	W OTOMAT KUTUSU (S/Ü) MEKSBOX 9 LÜ	1	20	225,62
001 027 000009 00 00	W OTOMAT KUTUSU (S/A) MEKSBOX 9 LÜ	1	20	222,64
001 027 100012 00 00	W OTOMAT KUTUSU (S/Ü) MEKSBOX 12 Lİ	1	10	264,95
001 027 000012 00 00	W OTOMAT KUTUSU (S/A) MEKSBOX 12 Lİ	1	10	271,17
001 027 100016 00 00	W OTOMAT KUTUSU (S/Ü) MEKSBOX 16 Lİ	1	10	337,81
001 027 000016 00 00	W OTOMAT KUTUSU (S/A) MEKSBOX 16 Lİ	1	10	359,83
001 027 100024 00 00	W OTOMAT KUTUSU (S/Ü) MEKSBOX 24 LÜ	1	5	459,63
001 027 000024 00 00	W OTOMAT KUTUSU (S/A) MEKSBOX 24 LÜ	1	5	457,28
001 027 100036 00 00	W OTOMAT KUTUSU (S/Ü) MEKSBOX 36 Lİ	1	5	603,65
001 027 000036 00 00	W OTOMAT KUTUSU (S/A) MEKSBOX 36 Lİ	1	5	624,84
MEKSBOX W OTOMAT KUTULARI - ALEV YAYMAYAN				
IP30				
001 027 210001 00 00	MÜH.W OTOMAT KUTUSU ALEV YAYMAYAN (S/Ü) 1 Lİ	20	160	38,32
001 027 210002 00 00	MÜH.W OTOMAT KUTUSU ALEV YAYMAYAN (S/Ü) 2 Lİ	20	80	57,28
001 027 210004 00 00	MÜH.W OTOMAT KUTUSU ALEV YAYMAYAN (S/Ü) 4 LÜ	10	80	64,18
001 027 110002 00 00	W OTOMAT KUTUSU (S/Ü) ALEV YAYMAYAN 2 Lİ	1	30	201,78
001 027 010002 00 00	W OTOMAT KUTUSU (S/A) ALEV YAYMAYAN 2 Lİ	1	30	229,16
001 027 110004 00 00	W OTOMAT KUTUSU (S/Ü) ALEV YAYMAYAN 4 LÜ	1	20	243,73
001 027 010004 00 00	W OTOMAT KUTUSU (S/A) ALEV YAYMAYAN 4 LÜ	1	20	232,69
001 027 110006 00 00	W OTOMAT KUTUSU (S/Ü) ALEV YAYMAYAN 6 Lİ	1	20	288,25
001 027 010006 00 00	W OTOMAT KUTUSU (S/A) ALEV YAYMAYAN 6 Lİ	1	20	275,1
001 027 110009 00 00	W OTOMAT KUTUSU (S/Ü) ALEV YAYMAYAN 9 LÜ	1	20	356,18
001 027 010009 00 00	W OTOMAT KUTUSU (S/A) ALEV YAYMAYAN 9 LÜ	1	20	344,64
001 027 110012 00 00	W OTOMAT KUTUSU (S/Ü) ALEV YAYMAYAN 12 Lİ	1	10	447,33
001 027 010012 00 00	W OTOMAT KUTUSU (S/A) ALEV YAYMAYAN 12 Lİ	1	10	472,53
001 027 110016 00 00	W OTOMAT KUTUSU (S/Ü) ALEV YAYMAYAN 16 Lİ	1	10	541,72
001 027 010016 00 00	W OTOMAT KUTUSU (S/A) ALEV YAYMAYAN 16 Lİ	1	10	545,97
001 027 110024 00 00	W OTOMAT KUTUSU (S/Ü) ALEV YAYMAYAN 24 LÜ	1	5	798,61
001 027 010024 00 00	W OTOMAT KUTUSU (S/A) ALEV YAYMAYAN 24 LÜ	1	5	785,83
001 027 110036 00 00	W OTOMAT KUTUSU (S/Ü) ALEV YAYMAYAN 36 Lİ	1	5	1137,5
001 027 010036 00 00	W OTOMAT KUTUSU (S/A) ALEV YAYMAYAN 36 Lİ	1	5	1151,67



SPİRALLİ KABLolar

Tüm spirallerin HALOJEN FREE özelliği mevcuttur.

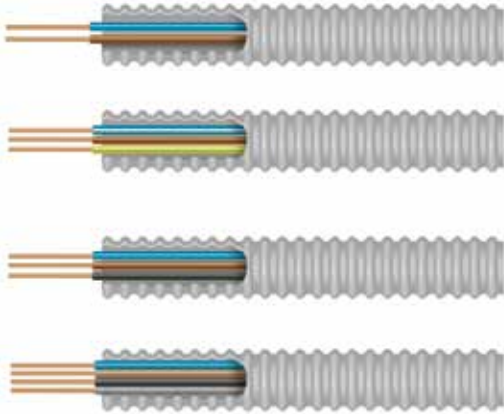

SPİRALLİ ENERJİ KABLolar HALOJEN FREE



Ürün Kodu	Kablo Kesit (mm ²)	Spiral Özellik	Spiral Çap (Ø mm)
H07Z1-U (NYA) KABLolar HALOJEN FREE			
122 051 215014	2 x 1,5	HF-PE	16
122 051 315014	3 x 1,5	HF-PE	16
122 051 415016	4 x 1,5	HF-PE	16
122 051 515020	5 x 1,5	HF-PE	20
122 051 225014	2 x 2,5	HF-PE	16
122 051 325016	3 x 2,5	HF-PE	16
122 051 425020	4 x 2,5	HF-PE	16
122 051 525025	5 x 2,5	HF-PE	25

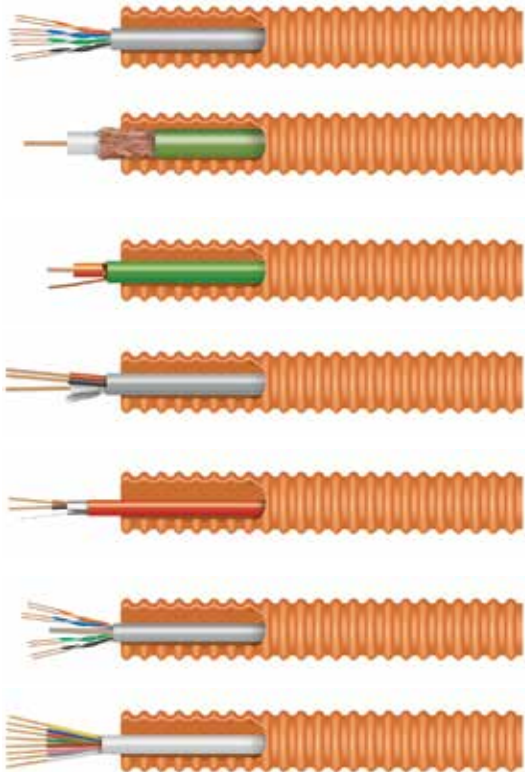

SPİRALLİ ZAYIF AKIM KABLolar HALOJEN FREE



Ürün Kodu	Kablo Kesit (mm ²)	Spiral Özellik	Spiral Çap (Ø mm)
(LSZH) DATA KABLolar HALOJEN FREE			
122 053 100516	U/UTP CAT5e (4x2x24AWG)	HF-PE	14
122 053 100616	U/UTP CAT6 (4x2x23AWG)	HF-PE	14
(PHY - HF) KOAKSİYEL KABLolar HALOJEN FREE			
122 053 200416	RG 6 U/4 (Cu/AL)	HF-PE	14
122 053 200616	RG 6 U/6 (Cu/Cu)	HF-PE	14
CCTV KAMERA KABLolar HALOJEN FREE			
122 053 301214	1+2 RG 59 Mini (2x0,50 mm ²)	HF-PE	14
122 053 301416	1+4 RG 59 Mini (2x0,50 mm ²) + (2x0,22 mm ²)	HF-PE	14
J-H (st) H YANGIN İHBAR KABLolar HALOJEN FREE			
122 053 401214	1x2x0,80 mm ² + 0,80 mm ²	HF-PE	14
122 053 402216	2x2x0,80 mm ² + 0,80 mm ²	HF-PE	14
LIHH DİYAFON KABLolar HALOJEN FREE			
122 053 502216	LIHH 8x0,22 mm ²	HF-PE	14

* Güncel fiyatlar için satış temsilciniz ile irtibata geçiniz.

SPİRALLİ KABLolar

Tüm spirallerin HALOJEN FREE özelliği mevcuttur.

SPİRALLİ ENERJİ KABLolar

Ürün Kodu	Kablo Kesit (mm ²)	Spiral Özellik	Spiral Çap (Ø mm)
H07Z1-U (NYA) KABLolar			
122 050 215014	2 x 1,5	HF-PE	16
122 050 315014	3 x 1,5	HF-PE	16
122 050 415016	4 x 1,5	HF-PE	16
122 050 515020	5 x 1,5	HF-PE	20
122 050 225014	2 x 2,5	HF-PE	16
122 050 325016	3 x 2,5	HF-PE	16
122 050 425020	4 x 2,5	HF-PE	16
122 050 525025	5 x 2,5	HF-PE	25

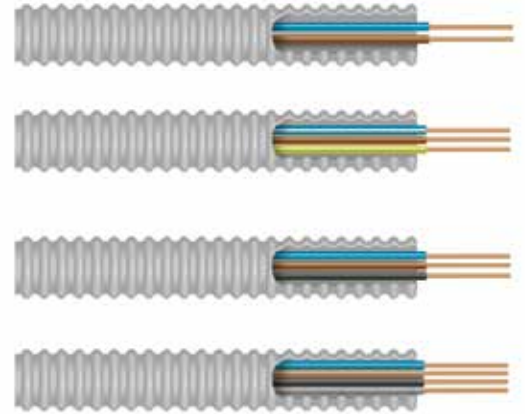







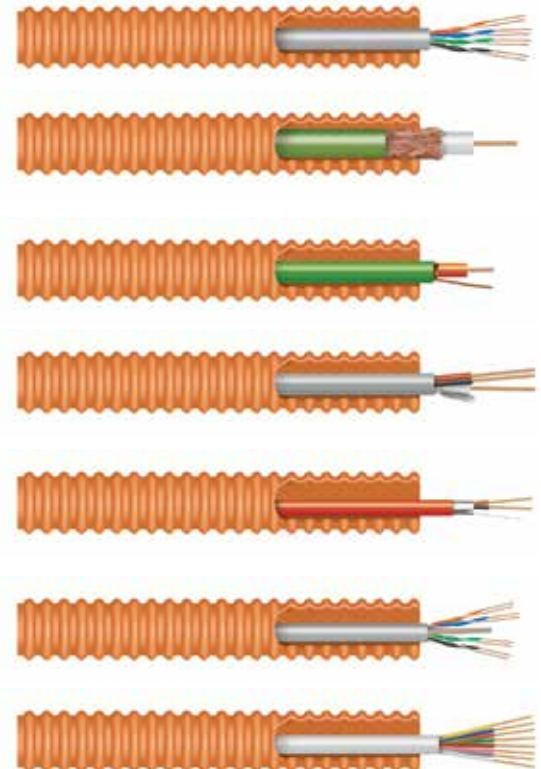

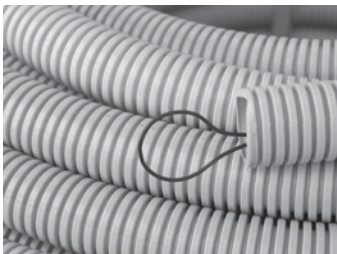
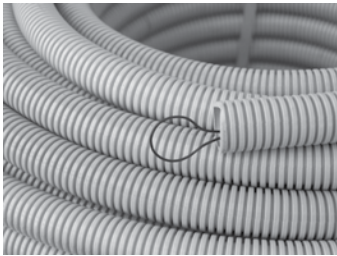
SPİRALLİ ZAYIF AKIM KABLolar

Ürün Kodu	Kablo Kesit (mm ²)	Spiral Özellik	Spiral Çap (Ø mm)
DATA KABLolar			
122 052 100516	U/UTP CAT5e	HF-PE	14
122 052 100616	U/UTP CAT6e	HF-PE	14
KOAKSİYEL KABLolar			
122 052 200416	RG 59 U/2 (Cu/AL)	HF-PE	14
122 052 200616	RG 6 U/4 (Cu/AL)	HF-PE	14
122 052 200616	RG 6 U/6 (Cu/Cu)	HF-PE	14
CCTV KAMERA KABLolar			
122 052 301214	CCTV 1+2 (2x0,22 mm ²)	HF-PE	14
122 052 301416	CCTV 1+4 (2x2x0,22 mm ²)	HF-PE	14
J-H (st) H YANGIN İHBAR KABLolar			
122 052 401215	JY(st)Y 1x2x0,80 mm ² + 0,40 mm ²	HF-PE	14
122 052 402216	JY(st)Y 2x2x0,80 mm ² + 0,40 mm ²	HF-PE	14
LIHH DİYAFON KABLolar			
122 052 502216	DT-8 8x0,22 mm ²	HF-PE	14

* Güncel fiyatlar için satış temsilciniz ile irtibata geçiniz.





Ürün Kodu	Ürün Adı	Ort. İç Çap	Ort. Dış Çap	Kutu Mt.	Koli Adet	Fiyat (₺)
HAFİF SERİ PVC SİRALLER - ALEV YAYMAYAN (320N) 						
001 020 010016 00 17	16 Ø A.YAYMAYAN SİRAL (HAFİF SERİ)	11,4	15,85	100 mt.	500	8,17
001 020 010020 00 17	20 Ø A.YAYMAYAN SİRAL (HAFİF SERİ)	14,5	19,85	100 mt.	500	12,71
001 020 010025 00 17	25 Ø A.YAYMAYAN SİRAL (HAFİF SERİ)	18,7	24,8	50 mt.	250	17,25
001 020 010032 00 17	32 Ø A.YAYMAYAN SİRAL (HAFİF SERİ)	24,9	31,8	50 mt.	250	22,93
AĞIR SERİ PVC SİRALLER -ALEV YAYMAYAN (750N) 						
001 020 000016 00 17	16 Ø A.YAYMAYAN SİRAL (AĞIR SERİ)	11,2	15,85	100 mt.	500	9,08
001 020 000020 00 17	20 Ø A.YAYMAYAN SİRAL (AĞIR SERİ)	14,4	19,85	100 mt.	500	13,62
001 020 000025 00 17	25 Ø A.YAYMAYAN SİRAL (AĞIR SERİ)	18,1	24,8	50 mt.	250	18,17
001 020 000032 00 17	32 Ø A.YAYMAYAN SİRAL (AĞIR SERİ)	24,7	31,8	50 mt.	250	23,83
HAFİF SERİ PVC TELLİ SİRALLER - ALEV YAYMAYAN (320N) 						
001 020 120016 00 17	16 Ø TELLİ A.YAYMAYAN (HAFİF SERİ)	11,4	15,85	100 mt.	500	10,22
001 020 120020 00 17	20 Ø TELLİ A.YAYMAYAN (HAFİF SERİ)	14,5	19,85	100 mt.	500	13,85
001 020 120025 00 17	25 Ø TELLİ A.YAYMAYAN (HAFİF SERİ)	18,7	24,8	50 mt.	250	18,39
001 020 120032 00 17	32 Ø TELLİ A.YAYMAYAN (HAFİF SERİ)	24,9	31,8	50 mt.	250	24,07
AĞIR SERİ PVC TELLİ SİRALLER - ALEV YAYMAYAN (750N) 						
001 020 100016 00 17	16 Ø TELLİ A.YAYMAYAN (AĞIR SERİ)	11,2	15,85	100 mt.	500	10,68
001 020 100020 00 17	20 Ø TELLİ A.YAYMAYAN (AĞIR SERİ)	14,4	19,85	100 mt.	500	15,43
001 020 100025 00 17	25 Ø TELLİ A.YAYMAYAN (AĞIR SERİ)	18,1	24,8	50 mt.	250	20,18
001 020 100032 00 17	32 Ø TELLİ A.YAYMAYAN (AĞIR SERİ)	24,7	31,8	50 mt.	250	26,1
HALOJEN FREE SİRALLER -ALEV YAYAN (320N) 						
001 020 140016 00 17	16 Ø HALOJEN FREE SPR. (ALEV YAYAN)	11,2	15,7	100 mt.	500	5,2
001 020 140020 00 17	20 Ø HALOJEN FREE SPR. (ALEV YAYAN)	14,4	19,85	100 mt.	500	6,38
001 020 140025 00 17	25 Ø HALOJEN FREE SPR. (ALEV YAYAN)	19,1	24,7	50 mt.	250	8,71
001 020 140032 00 17	32 Ø HALOJEN FREE SPR. (ALEV YAYAN)	24,85	31,6	50 mt.	250	10,86
001 020 140040 00 17	40 Ø HALOJEN FREE SPR. (ALEV YAYAN)			25 mt.	125	17,89
001 020 140050 00 17	50 Ø HALOJEN FREE SPR. (ALEV YAYAN)			25 mt.	125	23,97
HALOJEN FREE SİRALLER -ALEV YAYAN (750N) 						
001 020 740020 00 17	20 Ø HALOJEN FREE SPR. (ALEV YAYAN)	14,4	19,85	100 mt.	500	21,83
001 020 740025 00 17	25 Ø HALOJEN FREE SPR. (ALEV YAYAN)	18,7	24,7	50 mt.	250	30,72
001 020 740032 00 17	32 Ø HALOJEN FREE SPR. (ALEV YAYAN)	24,2	31,6	50 mt.	250	39,61
HALOJEN FREE SİRALLER TELLİ - ALEV YAYAN (320N) 						
001 020 141016 00 17	16 Ø H.FREE SİRAL(A.YAYAN)(TELLİ)	11,2	15,7	100 mt.	500	6,53
001 020 141020 00 17	20 Ø H.FREE SİRAL(A.YAYAN)(TELLİ)	14,4	19,85	100 mt.	500	7,48
001 020 141025 00 17	25 Ø H.FREE SİRAL(A.YAYAN)(TELLİ)	19,1	24,7	50 mt.	250	9,65
001 020 141032 00 17	32 Ø H.FREE SİRAL(A.YAYAN)(TELLİ)	24,85	31,6	50 mt.	250	11,83
001 020 141040 00 17	40 Ø H.FREE SİRAL(A.YAYAN)(TELLİ)			25 mt.	125	18,73
HALOJEN FREE SİRALLER - ALEV YAYMAYAN (320N) 						
001 020 150016 00 17	16 Ø HALOJEN FREE SPR.(A.YAYMAYAN)	11,2	15,7	100 mt.	500	7,52
001 020 150020 00 17	20 Ø HALOJEN FREE SPR.(A.YAYMAYAN)	14,4	19,85	100 mt.	500	10,41
001 020 150025 00 17	25 Ø HALOJEN FREE SPR.(A.YAYMAYAN)	19,1	24,7	50 mt.	250	14,75
001 020 150032 00 17	32 Ø HALOJEN FREE SPR.(A.YAYMAYAN)	24,85	31,6	50 mt.	250	17,35
001 020 150040 00 17	40 Ø HALOJEN FREE SPR.(A.YAYMAYAN)			25 mt.	125	28,91
001 020 150050 00 17	50 Ø HALOJEN FREE SPR.(A.YAYMAYAN)			25 mt.	125	39,03
HALOJEN FREE SİRALLER - ALEV YAYMAYAN (750N) 						
001 020 750020 00 17	20 Ø HALOJEN FREE SPR. (ALEV YAYMAYAN)	14,4	19,85	100 mt.	500	22,34
001 020 750025 00 17	25 Ø HALOJEN FREE SPR. (ALEV YAYMAYAN)	18,7	24,7	50 mt.	250	31,44
001 020 750032 00 17	32 Ø HALOJEN FREE SPR. (ALEV YAYMAYAN)	24,2	31,6	50 mt.	250	40,55
HALOJEN FREE SİRALLER TELLİ - ALEV YAYMAYAN (320N) 						
001 020 151016 00 17	16 Ø H.FREE SPR.(A.YAYMAYAN)(TELLİ)	11,2	15,7	100 mt.	500	9,76
001 020 151020 00 17	20 Ø H.FREE SPR.(A.YAYMAYAN)(TELLİ)	14,4	19,85	100 mt.	500	12,36
001 020 151025 00 17	25 Ø H.FREE SPR.(A.YAYMAYAN)(TELLİ)	19,1	24,7	50 mt.	250	16,7
001 020 151032 00 17	32 Ø H.FREE SPR.(A.YAYMAYAN)(TELLİ)	24,85	31,6	50 mt.	250	19,59
001 020 151040 00 17	40 Ø H.FREE SPR.(A.YAYMAYAN)(TELLİ)			25 mt.	125	31,16

Ürün Kodu	Ürün Adı	Ort. İç Çap	Ort. Dış Çap	Kutu Mt./Ad.	Koli Adet	Fiyat (₺)
MEKS SERİSİ PLASTİK SİRALLER - SİYAH						
001 020 400012 00 11	12 Ø PLASTİK SİRALLER (SİYAH)	12,3	15,9	100 mt.	1000	4,18
001 020 400014 00 11	14 Ø PLASTİK SİRALLER (SİYAH)	15,25	18,75	100 mt.	1000	4,69
001 020 400016 00 11	16 Ø PLASTİK SİRALLER (SİYAH)	15,7	19	100 mt.	1000	4,69
001 020 400018 00 11	18 Ø PLASTİK SİRALLER (SİYAH)	19,6	24,03	50 mt.	500	7,69
001 020 400020 00 11	20 Ø PLASTİK SİRALLER (SİYAH)	19,6	24,03	50 mt.	500	7,69
001 020 400026 00 11	26 Ø PLASTİK SİRALLER (SİYAH)	26,15	30,75	50 mt.	250	10,3
001 020 400032 00 11	32 Ø PLASTİK SİRALLER (SİYAH)	29,1	34,3	50 mt.	250	11,32
001 020 400040 00 11	40 Ø PLASTİK SİRALLER (SİYAH)	36,2	42,2	25 mt.	125	18,36
001 020 400050 00 11	50 Ø PLASTİK SİRALLER (SİYAH)	48,5	54,5	25 mt.	125	22,91

MEKS SERİSİ PLASTİK SİRALLER - SİYAH - TELLİ

001 020 410014 00 11	14 Ø PLASTİK SİRALLER (SİYAH) TELLİ	15,25	18,75	100 mt.	1000	5,54
001 020 410016 00 11	16 Ø PLASTİK SİRALLER (SİYAH) TELLİ	15,7	19	100 mt.	1000	5,54
001 020 410018 00 11	18 Ø PLASTİK SİRALLER (SİYAH) TELLİ	19,6	24,03	50 mt.	500	8,54
001 020 410020 00 11	20 Ø PLASTİK SİRALLER (SİYAH) TELLİ	19,6	24,03	50 mt.	500	8,54
001 020 410026 00 11	26 Ø PLASTİK SİRALLER (SİYAH) TELLİ	26,15	30,75	50 mt.	250	11,15
001 020 410032 00 11	32 Ø PLASTİK SİRALLER (SİYAH) TELLİ	29,1	34,3	50 mt.	250	12,16
001 020 410040 00 11	40 Ø PLASTİK SİRALLER (SİYAH) TELLİ	36,2	42,2	25 mt.	125	19,21

PLASTİK SİRALLER - RENKLİ

001 020 400014 00 XX	14 Ø PLS. SİRAL (GRİ-BYZ-KIR-MAVİ)	15,25	18,75	100 mt.	1000	5,22
001 020 400016 00 XX	16 Ø PLS. SİRAL (GRİ-BYZ-KIR-MAVİ)	15,7	19	100 mt.	1000	5,22
001 020 400018 00 XX	18 Ø PLS. SİRAL (GRİ-BYZ-KIR-MAVİ)	19,6	24,03	50 mt.	500	8,54
001 020 400020 00 XX	20 Ø PLS. SİRAL (GRİ-BYZ-KIR-MAVİ)	19,6	24,03	50 mt.	500	8,54
001 020 400026 00 XX	26 Ø PLS. SİRAL (GRİ-BYZ-KIR-MAVİ)	26,15	30,75	50 mt.	250	11,45
001 020 400032 00 XX	32 Ø PLS. SİRAL (GRİ-BYZ-KIR-MAVİ)	29,1	34,3	50 mt.	250	12,64
001 020 400040 00 XX	40 Ø PLS. SİRAL (GRİ-BYZ-KIR-MAVİ)	36,2	42,2	25 mt.	125	20,39
001 020 400050 00 XX	50 Ø PLS. SİRAL (GRİ-BYZ-KIR-MAVİ)	48,5	54,5	25 mt.	125	25,31
001 020 990016 00 17	16 mm SİRAL EK MUFU (GRİ)				200 ad.	6,05
001 020 990020 00 17	20 mm SİRAL EK MUFU (GRİ)				200 ad.	6,96
001 020 990025 00 17	25 mm SİRAL EK MUFU (GRİ)				100 ad.	9,08
001 020 990032 00 17	32 mm SİRAL EK MUFU (GRİ)				200 ad.	12,14

KORUGE BORULAR (250N)

096 045 150050	50 Ø KORUGE KANGAL BORU	43	50	100 mt.		34,5
096 045 150060	63 Ø KORUGE KANGAL BORU	54	63	100 mt.		43,55
096 045 150075	75 Ø KORUGE KANGAL BORU	64	75	100 mt.		53,15
096 045 150100	100 Ø KORUGE BOY BORU (6 MT.)	87	100	6 mt.		64,58
096 045 150115	115 Ø KORUGE BOY BORU (6 MT.)	100	115	6 mt.		73,92
096 045 150004	50 Ø MANŞON				1 ad.	12,1
096 045 150003	75 Ø MANŞON				1 ad.	15,82
096 045 150002	100 Ø MANŞON				1 ad.	19,81
096 045 150001	115 Ø MANŞON				1 ad.	24,19

LOGAR KUTUSU

074 048 622020	20X20 LOGAR KUTUSU TAKIM				1 ad.	121,28
074 048 623030	30X30 LOGAR KUTUSU TAKIM				1 ad.	303,19
074 048 624040	40X40 LOGAR KUTUSU TAKIM				1 ad.	779,63
074 048 625555	55X55 LOGAR KUTUSU TAKIM				1 ad.	1342,69



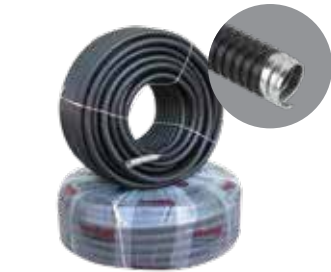

Ürün Kodu	Ürün Adı	Ort. İç Çap	Ort. Dış Çap	Kutu Mt.	Koli Adet	Fiyat (₺)
-----------	----------	-------------	--------------	----------	-----------	-----------

EKO SERİSİ ÇELİK SİRALLER

001 054 150009 00 66	9 Ø EKO ÇELİK SİRALLER	9	12,1	50 mt.	200	12,84
001 054 150011 00 66	11 Ø EKO ÇELİK SİRALLER (3/8")	11	14,1	50 mt.	200	13,03
001 054 150014 00 66	14 Ø EKO ÇELİK SİRALLER (1/2")	14	17,1	50 mt.	200	15,57
001 054 150016 00 66	16 Ø EKO ÇELİK SİRALLER	16	19,1	50 mt.	200	17,08
001 054 150018 00 66	18 Ø EKO ÇELİK SİRALLER	18	21,1	50 mt.	200	19,6
001 054 150021 00 66	21 Ø EKO ÇELİK SİRALLER (3/4")	21	24,1	50 mt.	200	21,81
001 054 150026 00 66	26 Ø EKO ÇELİK SİRALLER (1")	26	29,1	25 mt.	100	29,83
001 054 150029 00 66	29 Ø EKO ÇELİK SİRALLER (1 1/4")	29	32,1	25 mt.	100	32,26
001 054 150032 00 66	32 Ø EKO ÇELİK SİRALLER	32	35,1	25 mt.	100	34,32
001 054 150037 00 66	37 Ø EKO ÇELİK SİRALLER (1 1/2")	37	41,1	25 mt.	100	45,29
001 054 150042 00 66	42 Ø EKO ÇELİK SİRALLER	42	45,1	25 mt.	100	52,79
001 054 150050 00 66	50 Ø EKO ÇELİK SİRALLER (2")	50	53,1	25 mt.	100	73,24

EKO SERİSİ ÇELİK SİRALLER - KILAVUZ TELLİ

001 054 221011 00 66	11 Ø EKO Ç. SİRAL (TELLİ) (3/8")	11	14,1	50 mt.	200	15,4
001 054 221014 00 66	14 Ø EKO Ç. SİRAL (TELLİ) (1/2")	14	17,1	50 mt.	200	18,58
001 054 221016 00 66	16 Ø EKO Ç. SİRAL (TELLİ)	16	19,1	50 mt.	200	19,59
001 054 221018 00 66	18 Ø EKO Ç. SİRAL (TELLİ)	18	21,1	50 mt.	200	23,96
001 054 221021 00 66	21 Ø EKO Ç. SİRAL (TELLİ) (3/4")	21	24,1	50 mt.	200	24,1
001 054 221026 00 66	26 Ø EKO Ç. SİRAL (TELLİ) (1")	26	29,1	25 mt.	100	31,13
001 054 221029 00 66	29 Ø EKO Ç. SİRAL (TELLİ) (1 1/4")	29	32,1	25 mt.	100	33,66
001 054 221032 00 66	32 Ø EKO Ç. SİRAL (TELLİ)	32	35,1	25 mt.	100	40,01
001 054 221037 00 66	37 Ø EKO Ç. SİRAL (TELLİ) (1 1/2")	37	41,1	25 mt.	100	47,63
001 054 221042 00 66	42 Ø EKO Ç. SİRAL (TELLİ)	42	45,1	25 mt.	100	54,94
001 054 221050 00 66	50 Ø EKO Ç. SİRAL (TELLİ) (2")	50	53,1	25 mt.	100	73,32

EKO SERİSİ İZOLELİ ÇELİK SİRALLER

001 054 160009 00 11	9 Ø EKO İZOLELİ Ç. SİRAL	9	13,2	50 mt.		16,63
001 054 160011 00 11	11 Ø EKO İZOLELİ Ç. SİRAL (3/8")	11	15,2	50 mt.		17,88
001 054 160014 00 11	14 Ø EKO İZOLELİ Ç. SİRAL (1/2")	14	18,4	50 mt.		21,18
001 054 160016 00 11	16 Ø EKO İZOLELİ Ç. SİRAL	16	20,4	50 mt.		23,55
001 054 160018 00 11	18 Ø EKO İZOLELİ Ç. SİRAL	18	22,4	50 mt.		27,27
001 054 160021 00 11	21 Ø EKO İZOLELİ Ç. SİRAL (3/4")	21	25,4	50 mt.		32,46
001 054 160026 00 11	26 Ø EKO İZOLELİ Ç. SİRAL (1")	26	30,4	25 mt.		39,59
001 054 160029 00 11	29 Ø EKO İZOLELİ Ç. SİRAL (1 1/4")	29	33,4	25 mt.		43,23
001 054 160032 00 11	32 Ø EKO İZOLELİ Ç. SİRAL	32	36,4	25 mt.		48,12
001 054 160037 00 11	37 Ø EKO İZOLELİ Ç. SİRAL (1 1/2")	37	42,4	25 mt.		61,64
001 054 160042 00 11	42 Ø EKO İZOLELİ Ç. SİRAL	42	46,4	25 mt.		75,22
001 054 160050 00 11	50 Ø EKO İZOLELİ Ç. SİRAL (2")	50	54,4	25 mt.		100,37

EKO SERİSİ İZOLELİ ÇELİK SİRALLER - KILAVUZ TELLİ

001 054 231011 00 11	11 Ø EKO İZO.Ç. SPR. (TELLİ) (3/8")	11	15,2	50 mt.		20,25
001 054 231014 00 11	14 Ø EKO İZO.Ç. SPR. (TELLİ) (1/2")	14	18,4	50 mt.		24,46
001 054 231016 00 11	16 Ø EKO İZO.Ç. SPR. (TELLİ)	16	20,4	50 mt.		26,06
001 054 231018 00 11	18 Ø EKO İZO.Ç. SPR. (TELLİ)	18	22,4	50 mt.		29,4
001 054 231021 00 11	21 Ø EKO İZO.Ç. SPR. (TELLİ) (3/4")	21	25,4	50 mt.		34,51
001 054 231026 00 11	26 Ø EKO İZO.Ç. SPR. (TELLİ) (1")	26	30,4	25 mt.		42,32
001 054 231029 00 11	29 Ø EKO İZO.Ç. SPR. (TELLİ) (1 1/4")	29	33,4	25 mt.		45,4
001 054 231032 00 11	32 Ø EKO İZO.Ç. SPR. (TELLİ)	32	36,4	25 mt.		53,49
001 054 231037 00 11	37 Ø EKO İZO.Ç. SPR. (TELLİ) (1 1/2")	37	42,4	25 mt.		65,76
001 054 231042 00 11	42 Ø EKO İZO.Ç. SPR. (TELLİ)	42	46,4	25 mt.		77,23
001 054 231050 00 11	50 Ø EKO İZO.Ç. SPR. (TELLİ) (2")	50	54,4	25 mt.		101,37

MEKS SERİSİ ÇELİK SİRALLER

001 054 120009 00 66	9 Ø ÇELİK SİRALLER	9	12,1	50 mt.	200	13,77
001 054 120011 00 66	11 Ø ÇELİK SİRALLER (3/8")	11	14,1	50 mt.	200	14,2
001 054 120014 00 66	14 Ø ÇELİK SİRALLER (1/2")	14	17,1	50 mt.	200	16,97
001 054 120016 00 66	16 Ø ÇELİK SİRALLER	16	19,1	50 mt.	200	18,62
001 054 120018 00 66	18 Ø ÇELİK SİRALLER	18	21,1	50 mt.	200	21,37
001 054 120021 00 66	21 Ø ÇELİK SİRALLER (3/4")	21	24,1	50 mt.	200	24,86
001 054 120026 00 66	26 Ø ÇELİK SİRALLER (1")	26	29,1	25 mt.	100	32,55
001 054 120029 00 66	29 Ø ÇELİK SİRALLER (1 1/4")	29	32,1	25 mt.	100	34,92
001 054 120032 00 66	32 Ø ÇELİK SİRALLER	32	35,1	25 mt.	100	38,7
001 054 120037 00 66	37 Ø ÇELİK SİRALLER (1 1/2")	37	41,1	25 mt.	100	48,76
001 054 120042 00 66	42 Ø ÇELİK SİRALLER	42	45,1	25 mt.	100	59,23
001 054 120050 00 66	50 Ø ÇELİK SİRALLER (2")	50	53,1	25 mt.	100	82,13
001 054 120063 00 66	63 Ø ÇELİK SİRALLER	63	66,1	15 mt.	60	111,84

MEKS SERİSİ ÇELİK SİRALLER (KILAVUZ TELLİ)

001 054 121011 00 66	11 Ø Ç. SİRAL (TELLİ) (3/8")	11	14,1	50 mt.	200	16,79
001 054 121014 00 66	14 Ø Ç. SİRAL (TELLİ) (1/2")	14	17,1	50 mt.	200	20,26
001 054 121016 00 66	16 Ø Ç. SİRAL (TELLİ)	16	19,1	50 mt.	200	21,37
001 054 121018 00 66	18 Ø Ç. SİRAL (TELLİ)	18	21,1	50 mt.	200	26,14
001 054 121021 00 66	21 Ø Ç. SİRAL (TELLİ) (3/4")	21	24,1	50 mt.	200	26,66
001 054 121026 00 66	26 Ø Ç. SİRAL (TELLİ) (1")	26	29,1	25 mt.	100	35,53
001 054 121029 00 66	29 Ø Ç. SİRAL (TELLİ) (1 1/4")	29	32,1	25 mt.	100	36,58
001 054 121032 00 66	32 Ø Ç. SİRAL (TELLİ)	32	35,1	25 mt.	100	44,91
001 054 121037 00 66	37 Ø Ç. SİRAL (TELLİ) (1 1/2")	37	41,1	25 mt.	100	51,31
001 054 121042 00 66	42 Ø Ç. SİRAL (TELLİ)	42	45,1	25 mt.	100	61,65
001 054 121050 00 66	50 Ø Ç. SİRAL (TELLİ) (2")	50	53,1	25 mt.	100	82,24
001 054 121063 00 66	63 Ø Ç. SİRAL (TELLİ) (2")	63	66,1	15 mt.	60	106,75

Ürün Kodu	Ürün Adı	Ort. İç Çap	Ort. Dış Çap	Kutu Mt./Ad.	Koli Adet	Fiyat (₺)
MEKS SERİSİ İZOLELİ ÇELİK SİRALAR						
001 054 130009 00 11	9 Ø İZOLELİ Ç. SİRAL	9	13,2	50 mt.		17,38
001 054 130011 00 11	11 Ø İZOLELİ Ç. SİRAL(3/8")	11	15,2	50 mt.		19,49
001 054 130014 00 11	14 Ø İZOLELİ Ç. SİRAL(1/2")	14	18,4	50 mt.		23,12
001 054 130016 00 11	16 Ø İZOLELİ Ç. SİRAL	16	20,4	50 mt.		25,68
001 054 130018 00 11	18 Ø İZOLELİ Ç. SİRAL	18	22,4	50 mt.		29,73
001 054 130026 00 11	26 Ø İZOLELİ Ç. SİRAL(1")	26	30,4	25 mt.		43,01
001 054 130029 00 11	29 Ø İZOLELİ Ç. SİRAL(1 1/4")	29	33,4	25 mt.		48,58
001 054 130032 00 11	32 Ø İZOLELİ Ç. SİRAL	32	36,4	25 mt.		56,4
001 054 130037 00 11	37 Ø İZOLELİ Ç. SİRAL (1 1/2")	37	42,4	25 mt.		66,91
001 054 130042 00 11	42 Ø İZOLELİ Ç. SİRAL	42	46,4	25 mt.		84,35
001 054 130050 00 11	50 Ø İZOLELİ Ç. SİRAL(2")	50	54,4	25 mt.		112,52
001 054 130063 00 11	63 Ø İZOLELİ ÇELİK SİRAL	63	67,2	15 mt.		143,9



MEKS SERİSİ İZOLELİ ÇELİK SİRALAR - KILAVUZ TELLİ

001 054 140011 00 11	11 Ø İZO.Ç. SPR.(TELLİ)(3/8")	11	15,2	50 mt.		22,09
001 054 140014 00 11	14 Ø İZO.Ç. SPR.(TELLİ)(1/2")	14	18,4	50 mt.		26,67
001 054 140016 00 11	16 Ø İZO.Ç. SPR. (TELLİ)	16	20,4	50 mt.		28,07
001 054 140018 00 11	18 Ø İZO.Ç. SPR.(TELLİ)	18	22,4	50 mt.		31,64
001 054 140026 00 11	26 Ø İZO.Ç. SPR.(TELLİ)(1")	26	30,4	25 mt.		45,98
001 054 140029 00 11	29 Ø İZO.Ç. SPR.(TELLİ)(1 1/4")	29	33,4	25 mt.		51,3
001 054 140032 00 11	32 Ø İZO.Ç. SPR.(TELLİ)	32	36,4	25 mt.		60,18
001 054 140037 00 11	37 Ø İZO.Ç. SPR.(TELLİ)(1 1/2")	37	42,4	25 mt.		70,89
001 054 140042 00 11	42 Ø İZO.Ç. SPR.(TELLİ)	42	46,4	25 mt.		86,6
001 054 140050 00 11	50 Ø İZO.Ç. SPR.(TELLİ) (2")	50	54,4	25 mt.		113,64
001 054 140063 00 11	63 Ø İZO.Ç. SPR.(TELLİ)	63	67,2	15 mt.		137,98



NİKEL KAPLI ÇELİK SİRAL RAKORU

012 097 030009	CLK- 9 ÇELİK SİRAL RAKORU			1 ad.		129,94
012 097 030011	CLK-11 ÇELİK SİRAL RAKORU			1 ad.		151,59
012 097 030014	CLK-13,5 ÇELİK SİRAL RAKORU			1 ad.		181,91
012 097 030016	CLK-16 ÇELİK SİRAL RAKORU			1 ad.		203,57
012 097 030018	CLK-18 ÇELİK SİRAL RAKORU			1 ad.		238,22
012 097 030026	CLK-26 ÇELİK SİRAL RAKORU			1 ad.		294,53



SÜPER ETANJ METAL RAKORLAR

057 097 100007	PG-7 METAL RAKOR			1 ad.		1,98 €
057 097 100009	PG-9 METAL RAKOR			1 ad.	€	2,48 €
057 097 100011	PG-11 METAL RAKOR			1 ad.		3,34 €
057 097 100135	PG-13,5 METAL RAKOR			1 ad.		3,55 €
€ 057 097 100016	PG-16 METAL RAKOR			1 ad.		4,41 €
057 097 100021	PG-21 METAL RAKOR			1 ad.		7,51 €
057 097 100029	PG-29 METAL RAKOR			1 ad.		18,93 €
057 097 100036	PG-36 METAL RAKOR			1 ad.		27,64 €
057 097 100042	PG-42 METAL RAKOR			1 ad.		39,06 €
057 097 100048	PG-48 METAL RAKOR			1 ad.		46,9 €



PİRİNÇ RAKORLAR - NORMAL

012 097 010009	9 Ø PİRİNÇ RAKOR (NORMAL)			1 ad.		82,5
012 097 010011	11 Ø PİRİNÇ RAKOR (NORMAL)			1 ad.		103,13
012 097 010135	13,5 Ø PİRİNÇ RAKOR (NORMAL)			1 ad.		111,38
012 097 010016	16 Ø PİRİNÇ RAKOR (NORMAL)			1 ad.		132
012 097 010021	21 Ø PİRİNÇ RAKOR (NORMAL)			1 ad.		198
012 097 010029	29 Ø PİRİNÇ RAKOR (NORMAL)			1 ad.		334,13
012 097 010036	36 Ø PİRİNÇ RAKOR (NORMAL)			1 ad.		577,5
012 097 010042	42 Ø PİRİNÇ RAKOR (NORMAL)			1 ad.		693



PİRİNÇ RAKORLAR (KELEPÇELİ)

012 097 020009	9 Ø PİRİNÇ RAKOR (KELEPÇELİ)			1 ad.		160,88
012 097 020011	11 Ø PİRİNÇ RAKOR (KELEPÇELİ)			1 ad.		181,5
012 097 020135	13,5 Ø PİRİNÇ RAKOR (KELEPÇELİ)			1 ad.		198
012 097 020016	16 Ø PİRİNÇ RAKOR (KELEPÇELİ)			1 ad.		218,63
012 097 020021	21 Ø PİRİNÇ RAKOR (KELEPÇELİ)			1 ad.		297
012 097 020029	29 Ø PİRİNÇ RAKOR (KELEPÇELİ)			1 ad.		495
012 097 020036	36 Ø PİRİNÇ RAKOR (KELEPÇELİ)			1 ad.		812,63
012 097 020042	42 Ø PİRİNÇ RAKOR (KELEPÇELİ)			1 ad.		1138,5





Ürün Kodu	Ürün Adı	Kutu Mt.	Koli Adet	Fiyat (₺)	
PVC ALEV YAYMAYAN BOY BORULAR					
001 045 120014 30 17	14 Ø PVC ALEV YAYMAYAN BOY BORU (BOY: 3 MT)	☐ ☐	102 mt.	11,52	
001 045 120016 30 17	16 Ø PVC ALEV YAYMAYAN BOY BORU (BOY: 3 MT)	☐ ☐ ☐	102 mt.	13,75	
001 045 120018 30 17	18 Ø PVC ALEV YAYMAYAN BOY BORU (BOY: 3 MT)	☐ ☐	102 mt.	15,26	
001 045 120020 30 17	20 Ø PVC ALEV YAYMAYAN BOY BORU (BOY: 3 MT)	☐ ☐ ☐	102 mt.	20	
001 045 120025 30 17	25 Ø PVC ALEV YAYMAYAN BOY BORU (BOY: 3 MT)	☐ ☐ ☐	51 mt.	27,23	
001 045 120032 30 17	32 Ø PVC ALEV YAYMAYAN BOY BORU (BOY: 3 MT)	☐ ☐ ☐	30 mt.	44,23	
001 045 120040 30 17	40 Ø PVC ALEV YAYMAYAN BOY BORU (BOY: 3 MT)	☐ ☐ ☐	30 mt.	85,2	
PVC ALEV YAYMAYAN KENDİNDEN MUFLU BOY BORULAR					
001 045 110014 30 17	14 Ø PVC ALEV YAYMAYAN KENDİNDEN MUFLU BOY BORU (3M)	☐ ☐	102 mt.	17,68	
001 045 110016 30 17	16 Ø PVC ALEV YAYMAYAN KENDİNDEN MUFLU BOY BORU (3M)	☐ ☐ ☐	102 mt.	19,99	
001 045 110018 30 17	18 Ø PVC ALEV YAYMAYAN KENDİNDEN MUFLU BOY BORU (3M)	☐ ☐	102 mt.	21,56	
001 045 110020 30 17	20 Ø PVC ALEV YAYMAYAN KENDİNDEN MUFLU BOY BORU (3M)	☐ ☐ ☐	102 mt.	26,06	
001 045 110025 30 17	25 Ø PVC ALEV YAYMAYAN KENDİNDEN MUFLU BOY BORU (3M)	☐ ☐ ☐	51 mt.	32,76	
001 045 110032 30 17	32 Ø PVC ALEV YAYMAYAN KENDİNDEN MUFLU BOY BORU (3M)	☐ ☐ ☐	30 mt.	58,47	
001 045 110040 30 17	40 Ø PVC ALEV YAYMAYAN KENDİNDEN MUFLU BOY BORU (3M)	☐ ☐ ☐	30 mt.	111,22	
DİRSEK VE MUFLAR - ALEV YAYMAYAN					
001 051 010014 00 17	14 Ø DİRSEK ALEV YAYMAYAN	☐ ☐	100 ad.	7,43	
001 051 010016 00 17	16 Ø DİRSEK ALEV YAYMAYAN	☐ ☐ ☐	100 ad.	7,5	
001 051 010018 00 17	18 Ø DİRSEK ALEV YAYMAYAN	☐ ☐	100 ad.	7,58	
001 051 010020 00 17	20 Ø DİRSEK ALEV YAYMAYAN	☐ ☐ ☐	100 ad.	8,14	
001 051 010025 00 17	25 Ø DİRSEK ALEV YAYMAYAN	☐ ☐ ☐	50 ad.	16,13	
001 051 010032 00 17	32 Ø DİRSEK ALEV YAYMAYAN	☐ ☐ ☐	50 ad.	29,42	
001 051 030014 00 17	14-16 Ø MUF ALEV YAYMAYAN	☐ ☐ ☐	100 ad.	3,8	
001 051 030018 00 17	18-20 Ø MUF ALEV YAYMAYAN	☐ ☐ ☐	100 ad.	4	
001 051 030025 00 17	25 Ø MUF ALEV YAYMAYAN	☐ ☐ ☐	50 ad.	14,07	
001 051 030032 00 17	32 Ø MUF ALEV YAYMAYAN	☐ ☐ ☐	50 ad.	15,78	
GEÇMELİ TİP ANTİGRON BORU KROŞESİ					
001 048 010016 00 17	16 Ø ANTİGRON BORU KROŞESİ (GEÇMELİ)		100 ad.	2000	2,03
001 048 010018 00 17	18 Ø ANTİGRON BORU KROŞESİ (GEÇMELİ)		100 ad.	3000	2,78
001 048 010020 00 17	20 Ø ANTİGRON BORU KROŞESİ (GEÇMELİ)		100 ad.	1500	2,86
001 048 010025 00 17	25 Ø ANTİGRON BORU KROŞESİ (GEÇMELİ)		100 ad.	1000	3,04
001 048 010032 00 17	32 Ø ANTİGRON BORU KROŞESİ (GEÇMELİ)		100 ad.	800	3,57
001 048 010040 00 17	40 Ø ANTİGRON BORU KROŞESİ (GEÇMELİ)		50 ad.	750	4,79
074 048 050016	16 Ø ANTİGRON BORU KROŞESİ KAPAKLI(GEÇMELİ)		100 ad.	4000	1,85
074 048 050017	20 Ø ANTİGRON BORU KROŞESİ KAPAKLI(GEÇMELİ)		100 ad.	2500	1,91
074 048 050025	25 Ø ANTİGRON BORU KROŞESİ KAPAKLI(GEÇMELİ)		100 ad.	2500	3,03
074 048 050032	32 Ø ANTİGRON BORU KROŞESİ KAPAKLI(GEÇMELİ)		50 ad.	1500	3,75
FİBER SUSTALAR					
999 999 000779	FİBER KILAVUZ 11MM (100-120-150-200M)		1 mt.		89,45
999 999 000780	FİBER KILAVUZ MAKARASI		1 ad.		4924,46
PVC İZOLE KAPLI ÇELİK SUSTA					
049 019 300010	10 MT. PVC.İZOLE KAPLI ÇELİK SUSTA		1 ad.	30	224,85
049 019 300015	15 MT. PVC.İZOLE KAPLI ÇELİK SUSTA		1 ad.	24	337,28
049 019 300020	20 MT. PVC.İZOLE KAPLI ÇELİK SUSTA		1 ad.	20	449,71
049 019 300025	25 MT. PVC.İZOLE KAPLI ÇELİK SUSTA		1 ad.	18	562,13
PLASTİK SUSTALAR - KILAVUZ TELLİ					
049 019 400010	10 MT. KILAVUZ TELLİ PLASTİK SUSTA		1 ad.	25	101,65
049 019 400015	15 MT. KILAVUZ TELLİ PLASTİK SUSTA		1 ad.	20	152,48
049 019 400020	20 MT. KILAVUZ TELLİ PLASTİK SUSTA		1 ad.	15	203,30
049 019 400025	25 MT. KILAVUZ TELLİ PLASTİK SUSTA		1 ad.	15	254,13
ÇELİK SUSTA ve ZİNCİR					
001 019 000010 00 00	SUSTA (1.KALİTE) (10M)		40 ad.	40	172,72
001 019 000015 00 00	SUSTA (1.KALİTE) (15M)		30 ad.	30	252,98
001 019 000020 00 00	SUSTA (1.KALİTE) (20M)		20 ad.	20	332,35
001 019 000025 00 00	SUSTA (1.KALİTE) (25M)		15 ad.	15	412,34
001 019 100010 00 00	TAKVİYELİ SUSTA(1.KALİTE)(10M)		40 ad.	40	184,83
001 019 100015 00 00	TAKVİYELİ SUSTA(1.KALİTE)(15M)		30 ad.	30	265,57
001 019 100020 00 00	TAKVİYELİ SUSTA(1.KALİTE)(20M)		20 ad.	20	354,05
001 019 100025 00 00	TAKVİYELİ SUSTA(1.KALİTE)(25M)		15 ad.	15	440,67
001 018 000001 00 00	FLORESAN ZİNCİRİ		100 mt.	500	13,55



Ürün Kodu	Ürün Adı	Kutu Mt./Ad.	Koli Adet	Fiyat (₺)
SİBOR BOY BORU - HALOJEN FREE - ALEV YAYAN - 320N				€€
001 045 600016 30 17	16 Ø (H.FREE)(A.YAYAN)BOY BORU (3M)(GRİ)(SİBOR)	102 mt.		12
001 045 600020 30 17	20 Ø (H.FREE)(A.YAYAN)BOY BORU (3M)(GRİ)(SİBOR)	102 mt.		15,84
001 045 600025 30 17	25 Ø (H.FREE)(A.YAYAN)BOY BORU (3M)(GRİ)(SİBOR)	51 mt.		20,66
001 045 600032 30 17	32 Ø (H.FREE)(A.YAYAN)BOY BORU (3M)(GRİ)(SİBOR)	30 mt.		30,42
SİBOR BOY BORU - HALOJEN FREE - ALEV YAYMAYAN - 320N				€€
001 045 160016 30 17	16 Ø (H.FREE)(A.YAYMAYAN)BOY BORU (3M)(GRİ)(SİBOR)	102 mt.		20,69
001 045 160020 30 17	20 Ø (H.FREE)(A.YAYMAYAN)BOY BORU (3M)(GRİ)(SİBOR)	102 mt.		28,9
001 045 160025 30 17	25 Ø (H.FREE)(A.YAYMAYAN)BOY BORU (3M)(GRİ)(SİBOR)	51 mt.		39,55
001 045 160032 30 17	32 Ø (H.FREE)(A.YAYMAYAN)BOY BORU (3M)(GRİ)(SİBOR)	30 mt.		60,85
SİBOR BOY BORU - HALOJEN FREE - ALEV YAYAN - 750N				€€
001 045 610016 30 17	16 Ø (H.FREE)(A.YAYAN)BOY BORU (3M)(GRİ)(SİBOR)	102 mt.		13,34
001 045 610020 30 17	20 Ø (H.FREE)(A.YAYAN)BOY BORU (3M)(GRİ)(SİBOR)	102 mt.		19,2
001 045 610025 30 17	25 Ø (H.FREE)(A.YAYAN)BOY BORU (3M)(GRİ)(SİBOR)	51 mt.		22,68
001 045 610032 30 17	32 Ø (H.FREE)(A.YAYAN)BOY BORU (3M)(GRİ)(SİBOR)	30 mt.		33,47
SİBOR BOY BORU - HALOJEN FREE - ALEV YAYMAYAN - 750N				€€
001 045 161016 30 17	16 Ø (H.FREE)(A.YAYMAYAN)BOY BORU (3M)(GRİ)(SİBOR)	102 mt.		23,73
001 045 161020 30 17	20 Ø (H.FREE)(A.YAYMAYAN)BOY BORU (3M)(GRİ)(SİBOR)	102 mt.		36,51
001 045 161025 30 17	25 Ø (H.FREE)(A.YAYMAYAN)BOY BORU (3M)(GRİ)(SİBOR)	51 mt.		45,63
001 045 161032 30 17	32 Ø (H.FREE)(A.YAYMAYAN)BOY BORU (3M)(GRİ)(SİBOR)	30 mt.		69,97
BOY BORULAR - HALOJEN FREE - ALEV YAYMAYAN - FLARET - 320N				TS €€
001 045 500016 30 17	16 Ø HALOJEN FREE A.YAYMAYAN BORU(3M)(320N)	102 mt.		50,38
001 045 500020 30 17	20 Ø HALOJEN FREE A.YAYMAYAN BORU(3M)(320N)	102 mt.		61,24
001 045 500025 30 17	25 Ø HALOJEN FREE A.YAYMAYAN BORU(3M)(320N)	102 mt.		84,73
001 045 500032 30 17	32 Ø HALOJEN FREE A.YAYMAYAN BORU(3M)(320N)	102 mt.		119,66
001 045 500040 30 17	40 Ø HALOJEN FREE A.YAYMAYAN BORU(3M)(320N)	51 mt.		171,64
001 045 500050 30 17	50 Ø HALOJEN FREE A.YAYMAYAN BORU(3M)(320N)	30 mt.		292,11
BOY BORULAR - HALOJEN FREE - ALEV YAYMAYAN - FLARET - 750N				TS €€
001 045 510016 30 17	16 Ø HALOJEN FREE A.YAYMAYAN BORU(3M)(750N)	102 mt.		53,1
001 045 510020 30 17	20 Ø HALOJEN FREE A.YAYMAYAN BORU(3M)(750N)	102 mt.		66,67
001 045 510025 30 17	25 Ø HALOJEN FREE A.YAYMAYAN BORU(3M)(750N)	102 mt.		90,16
001 045 510032 30 17	32 Ø HALOJEN FREE A.YAYMAYAN BORU(3M)(750N)	102 mt.		125,09
001 045 510040 30 17	40 Ø HALOJEN FREE A.YAYMAYAN BORU(3M)(750N)	51 mt.		176,79
001 045 510050 30 17	50 Ø HALOJEN FREE A.YAYMAYAN BORU(3M)(750N)	30 mt.		348,35
BOY BORULAR - HALOJEN FREE - ALEV YAYMAYAN - FLARET - 1250N				TS €€
001 045 520016 30 17	16 Ø HALOJEN FREE A.YAYMAYAN BORU(3M)(1250N)	102 mt.		57,58
001 045 520020 30 17	20 Ø HALOJEN FREE A.YAYMAYAN BORU(3M)(1250N)	102 mt.		71,15
001 045 520025 30 17	25 Ø HALOJEN FREE A.YAYMAYAN BORU(3M)(1250N)	102 mt.		97,95
001 045 520032 30 17	32 Ø HALOJEN FREE A.YAYMAYAN BORU(3M)(1250N)	102 mt.		141,97
001 045 520040 30 17	40 Ø HALOJEN FREE A.YAYMAYAN BORU(3M)(1250N)	51 mt.		182,69
001 045 520050 30 17	50 Ø HALOJEN FREE A.YAYMAYAN BORU(3M)(1250N)	30 mt.		358,98
ŞEFFAF BORU - HALOJEN FREE - ALEV YAYAN - SİRİAL EK MUF				
999 999 777616	16 LİK ŞEFFAF H.F ALEV YAYAN BORU-SİRİAL EK MUFU	100 ad.	4000	9,49
999 999 777620	20 LİK ŞEFFAF H.F ALEV YAYAN BORU-SİRİAL EK MUFU	100 ad.	2000	9,8
999 999 777625	25 LİK ŞEFFAF H.F ALEV YAYAN BORU-SİRİAL EK MUFU	100 ad.	2000	13,6
999 999 777632	32 LİK ŞEFFAF H.F ALEV YAYAN BORU-SİRİAL EK MUFU	100 ad.	1000	17,08
DÜZ BORU T DİRSEK - HALOJEN FREE - ALEV YAYMAYAN				
999 999 999888	16 Ø DÜZ BORU T DİRSEK H.FREE ALEV YAYMAYAN	100 ad.	1500	21,18
999 999 999889	20 Ø DÜZ BORU T DİRSEK H.FREE ALEV YAYMAYAN	100 ad.	1000	21,48
999 999 999890	25 Ø DÜZ BORU T DİRSEK H.FREE ALEV YAYMAYAN	50 ad.	800	30,25
999 999 999891	32 Ø DÜZ BORU T DİRSEK H.FREE ALEV YAYMAYAN	25 ad.	500	39,33
DÜZ BORU RAKORU - HALOJEN FREE - ALEV YAYMAYAN				
999 999 998816	16 Ø DÜZ BORU RAKORU - H.FREE - ALEV YAYMAYAN	100 ad.	4000	20,56
999 999 998820	20 Ø DÜZ BORU RAKORU - H.FREE - ALEV YAYMAYAN	100 ad.	2500	22,77
999 999 998825	25 Ø DÜZ BORU RAKORU - H.FREE - ALEV YAYMAYAN	100 ad.	2000	25,93
999 999 998832	32 Ø DÜZ BORU RAKORU - H.FREE - ALEV YAYMAYAN	100 ad.	1000	34,79
ANTİGRON BORU KROŞESİ (GEÇMELİ) - HALOJEN FREE - ALEV YAYMAYAN				
074 048 060016	16 Ø ANT. BORU KROŞESİ(GEÇMELİ) KAPAKLI H.FREE A.YAYMAYAN	100 ad.	4000	4,11
074 048 060020	20 Ø ANT. BORU KROŞESİ(GEÇMELİ) KAPAKLI H.FREE A.YAYMAYAN	100 ad.	3500	4,74
074 048 060025	25 Ø ANT. BORU KROŞESİ(GEÇMELİ) KAPAKLI H.FREE A.YAYMAYAN	100 ad.	3000	5,69
074 048 060032	32 Ø ANT. BORU KROŞESİ(GEÇMELİ) KAPAKLI H.FREE A.YAYMAYAN	100 ad.	2000	6,96
SİRİAL RAKORU - HALOJEN FREE - ALEV YAYMAYAN				
999 999 777516	16 Ø SİRİAL RAKORU KAPAKLI H.FREE A.YAYMAYAN	100 ad.	4000	19,61
999 999 777520	20 Ø SİRİAL RAKORU KAPAKLI H.FREE A.YAYMAYAN	100 ad.	3000	23,72
999 999 777525	25 Ø SİRİAL RAKORU KAPAKLI H.FREE A.YAYMAYAN	100 ad.	1800	27,2
999 999 777532	32 Ø SİRİAL RAKORU KAPAKLI H.FREE A.YAYMAYAN	100 ad.	1000	34,79



999 999 777625



999 999 999889



999 999 999825



074 048 060025



999 999 777525

HF
HALOGEN
FREE



Ürün Kodu	Ürün Adı	Kutu Mt./Ad.	Koli Adet	Fiyat (₺)
SİBOR SERİSİ TURUNCU BORULAR - HALOJEN FREE - ALEV YAYAN - 125N				
001 165 706014 00 12	14 Ø BORU (H.FREE)(ALEV YAYAN) SİBOR	100 mt.		7,5
001 165 706016 00 12	16 Ø BORU (H.FREE)(ALEV YAYAN) SİBOR	100 mt.		8,52
001 165 706018 00 12	18 Ø BORU (H.FREE)(ALEV YAYAN) SİBOR	100 mt.		10,23
001 165 706020 00 12	20 Ø BORU (H.FREE)(ALEV YAYAN) SİBOR	100 mt.		11,25
001 165 706025 00 12	25 Ø BORU (H.FREE)(ALEV YAYAN) SİBOR	100 mt.		15,76
001 165 706032 00 12	32 Ø BORU (H.FREE)(ALEV YAYAN) SİBOR	100 mt.		26,27
001 165 706037 00 12	37 Ø BORU (H.FREE)(ALEV YAYAN) SİBOR	100 mt.		34,45
001 165 706040 00 12	40 Ø BORU (H.FREE)(ALEV YAYAN) SİBOR	100 mt.		38,14
001 165 706050 00 12	50 Ø BORU (H.FREE)(ALEV YAYAN) SİBOR	100 mt.		53,86
SİBOR SERİSİ BORULAR - HALOJEN FREE - ALEV YAYMAYAN - 125N				
001 165 206014 00 12	14 Ø BORU (H.FREE)(ALEV YAYMAYAN) SİBOR	100 mt.		14,83
001 165 206016 00 12	16 Ø BORU (H.FREE)(ALEV YAYMAYAN) SİBOR	100 mt.		17,53
001 165 206018 00 12	18 Ø BORU (H.FREE)(ALEV YAYMAYAN) SİBOR	100 mt.		20,49
001 165 206020 00 12	20 Ø BORU (H.FREE)(ALEV YAYMAYAN) SİBOR	100 mt.		23,46
001 165 206025 00 12	25 Ø BORU (H.FREE)(ALEV YAYMAYAN) SİBOR	100 mt.		32,36
001 165 206032 00 12	32 Ø BORU (H.FREE)(ALEV YAYMAYAN) SİBOR	100 mt.		53,93
001 165 206037 00 12	37 Ø BORU (H.FREE)(ALEV YAYMAYAN) SİBOR	100 mt.		67,41
001 165 206040 00 12	40 Ø BORU (H.FREE)(ALEV YAYMAYAN) SİBOR	100 mt.		75,5
001 165 206050 00 12	50 Ø BORU (H.FREE)(ALEV YAYMAYAN) SİBOR	100 mt.		110,56
SİBOR SERİSİ BORULAR - HALOJEN FREE - ALEV YAYAN - 320N				
001 165 710014 00 12	14 Ø BORU (H.FREE)(ALEV YAYAN) SİBOR	100 mt.		8,54
001 165 710016 00 12	16 Ø BORU (H.FREE)(ALEV YAYAN) SİBOR	100 mt.		9,59
001 165 710018 00 12	18 Ø BORU (H.FREE)(ALEV YAYAN) SİBOR	100 mt.		11,43
001 165 710020 00 12	20 Ø BORU (H.FREE)(ALEV YAYAN) SİBOR	100 mt.		14,45
001 165 710025 00 12	25 Ø BORU (H.FREE)(ALEV YAYAN) SİBOR	100 mt.		18,13
001 165 710032 00 12	32 Ø BORU (H.FREE)(ALEV YAYAN) SİBOR	100 mt.		28,9
001 165 710037 00 12	37 Ø BORU (H.FREE)(ALEV YAYAN) SİBOR	100 mt.		38,75
001 165 710040 00 12	40 Ø BORU (H.FREE)(ALEV YAYAN) SİBOR	100 mt.		48,34
001 165 710050 00 12	50 Ø BORU (H.FREE)(ALEV YAYAN) SİBOR	100 mt.		66,47
SİBOR SERİSİ BORULAR - HALOJEN FREE - ALEV YAYMAYAN - 320N				
001 165 210014 00 12	14 Ø BORU (H.FREE)(ALEV YAYMAYAN) SİBOR	100 mt.		17,53
001 165 210016 00 12	16 Ø BORU (H.FREE)(ALEV YAYMAYAN) SİBOR	100 mt.		19,68
001 165 210018 00 12	18 Ø BORU (H.FREE)(ALEV YAYMAYAN) SİBOR	100 mt.		23,46
001 165 210020 00 12	20 Ø BORU (H.FREE)(ALEV YAYMAYAN) SİBOR	100 mt.		29,66
001 165 210025 00 12	25 Ø BORU (H.FREE)(ALEV YAYMAYAN) SİBOR	100 mt.		37,21
001 165 210032 00 12	32 Ø BORU (H.FREE)(ALEV YAYMAYAN) SİBOR	100 mt.		59,32
001 165 210037 00 12	37 Ø BORU (H.FREE)(ALEV YAYMAYAN) SİBOR	100 mt.		79,55
001 165 210040 00 12	40 Ø BORU (H.FREE)(ALEV YAYMAYAN) SİBOR	100 mt.		99,23
001 165 210050 00 12	50 Ø BORU (H.FREE)(ALEV YAYMAYAN) SİBOR	100 mt.		136,18
MEKS SERİSİ TURUNCU BORULAR - HALOJEN FREE - ALEV YAYAN - 320N - 6 ATÜ				
001 165 506014 00 12	Ø14/6 ATÜ BORU (H.FREE)(A.YAYAN)	100 mt.		8,97
001 165 506016 00 12	Ø16/6 ATÜ BORU (H.FREE)(A.YAYAN)	100 mt.		10,91
001 165 506018 00 12	Ø18/6 ATÜ BORU (H.FREE)(A.YAYAN)	100 mt.		12,57
001 165 506020 00 12	Ø20/6 ATÜ BORU (H.FREE)(A.YAYAN)	100 mt.		14,4
001 165 506025 00 12	Ø25/6 ATÜ BORU (H.FREE)(A.YAYAN)	100 mt.		18,79
001 165 506032 00 12	Ø32/6 ATÜ BORU (H.FREE)(A.YAYAN)	100 mt.		28,91
001 165 506037 00 12	Ø37/6 ATÜ BORU (H.FREE)(A.YAYAN)	100 mt.		41,47
001 165 506040 00 12	Ø40/6 ATÜ BORU (H.FREE)(A.YAYAN)	100 mt.		47,05
001 165 506050 00 12	Ø50/6 ATÜ BORU (H.FREE)(A.YAYAN)	100 mt.		63,89
001 165 506063 00 12	Ø63/6 ATÜ BORU (H.FREE)(A.YAYAN)	100 mt.		91,08
001 165 506075 00 12	Ø75/6 ATÜ BORU (H.FREE)(A.YAYAN)	100 mt.		122,89
001 165 506090 00 12	Ø90/6 ATÜ BORU (H.FREE)(A.YAYAN)	100 mt.		187,94
MEKS SERİSİ TURUNCU BORULAR - HALOJEN FREE - ALEV YAYAN - 750N - 10 ATÜ				
001 165 510014 00 12	Ø14/10 ATÜ BORU (H.FREE)(A.YAYAN)	100 mt.		9,76
001 165 510016 00 12	Ø16/10 ATÜ BORU (H.FREE)(A.YAYAN)	100 mt.		12,13
001 165 510018 00 12	Ø18/10 ATÜ BORU (H.FREE)(A.YAYAN)	100 mt.		14,4
001 165 510020 00 12	Ø20/10 ATÜ BORU (H.FREE)(A.YAYAN)	100 mt.		17,45
001 165 510025 00 12	Ø25/10 ATÜ BORU (H.FREE)(A.YAYAN)	100 mt.		20,96
001 165 510032 00 12	Ø32/10 ATÜ BORU (H.FREE)(A.YAYAN)	100 mt.		31,81
001 165 510037 00 12	Ø37/10 ATÜ BORU (H.FREE)(A.YAYAN)	100 mt.		46,35
001 165 510040 00 12	Ø40/10 ATÜ BORU (H.FREE)(A.YAYAN)	100 mt.		54,37
001 165 510050 00 12	Ø50/10 ATÜ BORU (H.FREE)(A.YAYAN)	100 mt.		75,18
001 165 510063 00 12	Ø63/10 ATÜ BORU (H.FREE)(A.YAYAN)	100 mt.		108,43
001 165 510075 00 12	Ø75/10 ATÜ BORU (H.FREE)(A.YAYAN)	100 mt.		127,22
001 165 510090 00 12	Ø90/10 ATÜ BORU (H.FREE)(A.YAYAN)	100 mt.		216,86
001 165 510100 00 12	Ø100/10 ATÜ BORU (H.FREE)(A.YAYAN)	100 mt.		260,23
001 165 510110 00 12	Ø110/10 ATÜ BORU (H.FREE)(A.YAYAN)	100 mt.		289,14
MEKS SERİSİ TURUNCU BORULAR - HALOJEN FREE - ALEV YAYAN - 1250N				
001 165 512020 00 12	20 Ø BORU (H.FREE)(A.YAYAN)	100 mt.		30,16
001 165 512025 00 12	25 Ø BORU (H.FREE)(A.YAYAN)	100 mt.		38,25
001 165 512032 00 12	32 Ø BORU (H.FREE)(A.YAYAN)	100 mt.		56,84
MEKS SERİSİ TURUNCU BORULAR - HALOJEN FREE - ALEV YAYMAYAN - 320N - 6 ATÜ				
001 165 106014 00 12	Ø14/6 ATÜ BORU (H.FREE)(A.YAYMAYAN)	100 mt.		16,77
001 165 106016 00 12	Ø16/6 ATÜ BORU (H.FREE)(A.YAYMAYAN)	100 mt.		19,66
001 165 106018 00 12	Ø18/6 ATÜ BORU (H.FREE)(A.YAYMAYAN)	100 mt.		23,13
001 165 106020 00 12	Ø20/6 ATÜ BORU (H.FREE)(A.YAYMAYAN)	100 mt.		27,47
001 165 106025 00 12	Ø25/6 ATÜ BORU (H.FREE)(A.YAYMAYAN)	100 mt.		37,59
001 165 106032 00 12	Ø32/6 ATÜ BORU (H.FREE)(A.YAYMAYAN)	100 mt.		57,83
001 165 106037 00 12	Ø37/6 ATÜ BORU (H.FREE)(A.YAYMAYAN)	100 mt.		75,18
001 165 106040 00 12	Ø40/6 ATÜ BORU (H.FREE)(A.YAYMAYAN)	100 mt.		86,74
001 165 106050 00 12	Ø50/6 ATÜ BORU (H.FREE)(A.YAYMAYAN)	100 mt.		127,22
001 165 106063 00 12	Ø63/6 ATÜ BORU (H.FREE)(A.YAYMAYAN)	100 mt.		187,94
001 165 106075 00 12	Ø75/6 ATÜ BORU (H.FREE)(A.YAYMAYAN)	100 mt.		245,77
001 165 106090 00 12	Ø90/6 ATÜ BORU (H.FREE)(A.YAYMAYAN)	75 mt.		375,89
MEKS SERİSİ TURUNCU BORULAR - HALOJEN FREE - ALEV YAYMAYAN - 750N - 10 ATÜ				
001 165 110014 00 12	Ø14/10 ATÜ BORU (H.FREE)(A.YAYMAYAN)	100 mt.		19,08
001 165 110016 00 12	Ø16/10 ATÜ BORU (H.FREE)(A.YAYMAYAN)	100 mt.		22,55
001 165 110018 00 12	Ø18/10 ATÜ BORU (H.FREE)(A.YAYMAYAN)	100 mt.		27,47
001 165 110020 00 12	Ø20/10 ATÜ BORU (H.FREE)(A.YAYMAYAN)	100 mt.		34,7
001 165 110025 00 12	Ø25/10 ATÜ BORU (H.FREE)(A.YAYMAYAN)	100 mt.		43,37
001 165 110032 00 12	Ø32/10 ATÜ BORU (H.FREE)(A.YAYMAYAN)	100 mt.		66,5
001 165 110037 00 12	Ø37/10 ATÜ BORU (H.FREE)(A.YAYMAYAN)	100 mt.		86,74
001 165 110040 00 12	Ø40/10 ATÜ BORU (H.FREE)(A.YAYMAYAN)	100 mt.		106,98
001 165 110050 00 12	Ø50/10 ATÜ BORU (H.FREE)(A.YAYMAYAN)	100 mt.		150,35
001 165 110063 00 12	Ø63/10 ATÜ BORU (H.FREE)(A.YAYMAYAN)	100 mt.		216,86
001 165 110075 00 12	Ø75/10 ATÜ BORU (H.FREE)(A.YAYMAYAN)	100 mt.		254,45
001 165 110090 00 12	Ø90/10 ATÜ BORU (H.FREE)(A.YAYMAYAN)	75 mt.		433,71
001 165 110100 00 12	Ø100/10 ATÜ BORU (H.FREE)(A.YAYMAYAN)	50 mt.		520,46
001 165 110110 00 12	Ø110/10 ATÜ BORU (H.FREE)(A.YAYMAYAN)	50 mt.		578,29

HF
 HALOGEN
 FREE

Ürün Kodu	Ürün Adı	Kutu Mt./Ad.	Koli Adet	Fiyat (₺)
-----------	----------	--------------	-----------	-----------

MEKS SERİSİ BORULAR - HALOJEN FREE - ALEV YAYMAYAN - 1250N

001 165 112020 00 12	20 Ø BORU (H.FREE)(A.YAYMAYAN)	100 mt.		52,97
001 165 112025 00 12	25 Ø BORU (H.FREE)(A.YAYMAYAN)	100 mt.		67,49
001 165 112032 00 12	32 Ø BORU (H.FREE)(A.YAYMAYAN)	100 mt.		101,01

MEKS SERİSİ TURUNCU BORU - HALOJEN FREE - ALEV YAYAN - TELLİ - 320N - 6 ATÜ

001 165 906014 00 12	Ø14/6 ATÜ BORU(H.FREE)(A.YAYAN)(TELLİ)(TURUNCU)	100 mt.		9,65
001 165 906016 00 12	Ø16/6 ATÜ BORU(H.FREE)(A.YAYAN)(TELLİ)(TURUNCU)	100 mt.		11,59
001 165 906018 00 12	Ø18/6 ATÜ BORU(H.FREE)(A.YAYAN)(TELLİ)(TURUNCU)	100 mt.		13,25
001 165 906020 00 12	Ø20/6 ATÜ BORU(H.FREE)(A.YAYAN)(TELLİ)(TURUNCU)	100 mt.		15,08
001 165 906025 00 12	Ø25/6 ATÜ BORU(H.FREE)(A.YAYAN)(TELLİ)(TURUNCU)	100 mt.		19,46
001 165 906032 00 12	Ø32/6 ATÜ BORU(H.FREE)(A.YAYAN)(TELLİ)(TURUNCU)	100 mt.		29,59
001 165 906037 00 12	Ø37/6 ATÜ BORU(H.FREE)(A.YAYAN)(TELLİ)(TURUNCU)	100 mt.		42,15
001 165 906040 00 12	Ø40/6 ATÜ BORU(H.FREE)(A.YAYAN)(TELLİ)(TURUNCU)	100 mt.		47,73

MEKS SERİSİ TURUNCU BORU - HALOJEN FREE - ALEV YAYAN - TELLİ - 750N - 10 ATÜ

001 165 910014 00 12	Ø14/10 ATÜ BORU(H.FREE)(A.YAYAN)(TELLİ)(TURUNCU)	100 mt.		10,44
001 165 910016 00 12	Ø16/10 ATÜ BORU(H.FREE)(A.YAYAN)(TELLİ)(TURUNCU)	100 mt.		12,81
001 165 910018 00 12	Ø18/10 ATÜ BORU(H.FREE)(A.YAYAN)(TELLİ)(TURUNCU)	100 mt.		15,08
001 165 910020 00 12	Ø20/10 ATÜ BORU(H.FREE)(A.YAYAN)(TELLİ)(TURUNCU)	100 mt.		18,13
001 165 910025 00 12	Ø25/10 ATÜ BORU(H.FREE)(A.YAYAN)(TELLİ)(TURUNCU)	100 mt.		21,64
001 165 910032 00 12	Ø32/10 ATÜ BORU(H.FREE)(A.YAYAN)(TELLİ)(TURUNCU)	100 mt.		32,48
001 165 910037 00 12	Ø37/10 ATÜ BORU(H.FREE)(A.YAYAN)(TELLİ)(TURUNCU)	100 mt.		47,03
001 165 910040 00 12	Ø40/10 ATÜ BORU(H.FREE)(A.YAYAN)(TELLİ)(TURUNCU)	100 mt.		55,05

MEKS SERİSİ BORULAR - HALOJEN FREE - ALEV YAYMAYAN - TELLİ - 320N - 6 ATÜ

001 165 306014 00 12	Ø14/6 ATÜ BORU(H.FREE)(A.YAYMAYAN)(TELLİ)(TURUNCU)	100 mt.		17,45
001 165 306016 00 12	Ø16/6 ATÜ BORU(H.FREE)(A.YAYMAYAN)(TELLİ)(TURUNCU)	100 mt.		20,34
001 165 306018 00 12	Ø18/6 ATÜ BORU(H.FREE)(A.YAYMAYAN)(TELLİ)(TURUNCU)	100 mt.		23,81
001 165 306020 00 12	Ø20/6 ATÜ BORU(H.FREE)(A.YAYMAYAN)(TELLİ)(TURUNCU)	100 mt.		28,15
001 165 306025 00 12	Ø25/6 ATÜ BORU(H.FREE)(A.YAYMAYAN)(TELLİ)(TURUNCU)	100 mt.		38,27
001 165 306032 00 12	Ø32/6 ATÜ BORU(H.FREE)(A.YAYMAYAN)(TELLİ)(TURUNCU)	100 mt.		58,51
001 165 306037 00 12	Ø37/6 ATÜ BORU(H.FREE)(A.YAYMAYAN)(TELLİ)(TURUNCU)	100 mt.		75,85
001 165 306040 00 12	Ø40/6 ATÜ BORU(H.FREE)(A.YAYMAYAN)(TELLİ)(TURUNCU)	100 mt.		87,42

MEKS SERİSİ BORULAR - HALOJEN FREE - ALEV YAYMAYAN - TELLİ - 750N - 10 ATÜ

001 165 310014 00 12	Ø14/10 ATÜ BORU(H.FREE)(A.YAYMAYAN)(TELLİ)(TURUNCU)	100 mt.		19,76
001 165 310016 00 12	Ø16/10 ATÜ BORU(H.FREE)(A.YAYMAYAN)(TELLİ)(TURUNCU)	100 mt.		23,23
001 165 310018 00 12	Ø18/10 ATÜ BORU(H.FREE)(A.YAYMAYAN)(TELLİ)(TURUNCU)	100 mt.		28,15
001 165 310020 00 12	Ø20/10 ATÜ BORU(H.FREE)(A.YAYMAYAN)(TELLİ)(TURUNCU)	100 mt.		35,37
001 165 310025 00 12	Ø25/10 ATÜ BORU(H.FREE)(A.YAYMAYAN)(TELLİ)(TURUNCU)	100 mt.		44,05
001 165 310032 00 12	Ø32/10 ATÜ BORU(H.FREE)(A.YAYMAYAN)(TELLİ)(TURUNCU)	100 mt.		67,18
001 165 310037 00 12	Ø37/10 ATÜ BORU(H.FREE)(A.YAYMAYAN)(TELLİ)(TURUNCU)	100 mt.		87,42
001 165 310040 00 12	Ø40/10 ATÜ BORU(H.FREE)(A.YAYMAYAN)(TELLİ)(TURUNCU)	100 mt.		107,66

PLASTİK BORULAR

001 045 000014 30 00	14 MM KALIN BOY BORU	102 mt.	510 mt.	5,95
001 045 000018 30 00	18 MM KALIN BOY BORU	102 mt.	510 mt.	7,59
001 045 000026 30 00	26 MM KALIN BOY BORU	51 mt.	255 mt.	15,18
001 045 000037 30 00	37 MM KALIN BOY BORU	30 mt.		27,83
001 045 010014 00 11	14 MM KANGAL (NORMAL)	100 mt.		5,95
001 045 010018 00 11	18 MM KANGAL (NORMAL)	100 mt.		7,59
001 045 010026 00 11	26 MM KANGAL (NORMAL)	50 mt.		15,18
001 045 010037 00 11	37 MM KANGAL (NORMAL)	50 mt.		35,42
001 045 020014 00 00	14 MM KANGAL (KAUÇUK)	100 mt.		6,4
001 045 020018 00 00	18 MM KANGAL (KAUÇUK)	100 mt.		8,32
001 045 020026 00 00	26 MM KANGAL (KAUÇUK)	50 mt.		15,35
001 045 020037 00 00	37 MM KANGAL (KAUÇUK)	50 mt.		28,15
001 045 030014 00 00	14 MM KANGAL (KAUÇUK) (KALIN)	100 mt.		7,68
001 045 030018 00 00	18 MM KANGAL (KAUÇUK) (KALIN)	100 mt.		8,96

PLASTİK DİRSEK VE MUFLAR

127 051 000014	PLASTİK 14 Ø DİRSEK	100 ad.	2000	2,61
127 051 000018	PLASTİK 18 Ø DİRSEK	100 ad.	1000	3,33
127 051 000026	PLASTİK 26 Ø DİRSEK	100 ad.	500	5,68
001 051 020014 00 11	PLASTİK 14 Ø MUF		1500	1,66
001 051 020018 00 11	PLASTİK 18 Ø MUF		1000	2,7
001 051 020026 00 11	PLASTİK 26 Ø MUF		500	3,84
001 051 020037 00 11	PLASTİK 37 Ø MUF		250	5,31

POLİETİLEN SİYAH YERALTI BORULAR - 450N

001 165 406014 00 11	14/6 ATÜ POLİETİLEN BORU (SİYAH)	100 mt.		7,58
001 165 406016 00 11	16/6 ATÜ POLİETİLEN BORU (SİYAH)	100 mt.		8,86
001 165 406018 00 11	18/6 ATÜ POLİETİLEN BORU (SİYAH)	100 mt.		9,87
001 165 406020 00 11	20/6 ATÜ POLİETİLEN BORU (SİYAH)	100 mt.		12,02
001 165 406025 00 11	25/6 ATÜ POLİETİLEN BORU (SİYAH)	100 mt.		16,45
001 165 406032 00 11	32/6 ATÜ POLİETİLEN BORU (SİYAH)	100 mt.		25,3
001 165 406037 00 11	37/6 ATÜ POLİETİLEN BORU (SİYAH)	100 mt.		32,89
001 165 406040 00 11	40/6 ATÜ POLİETİLEN BORU (SİYAH)	100 mt.		37,95
001 165 406050 00 11	50/6 ATÜ POLİETİLEN BORU (SİYAH)	100 mt.		54,4
001 165 406063 00 11	63/6 ATÜ POLİETİLEN BORU (SİYAH)	100 mt.		79,7
001 165 406075 00 11	75/6 ATÜ POLİETİLEN BORU (SİYAH)	100 mt.		107,53
001 165 406090 00 11	90/6 ATÜ POLİETİLEN BORU (SİYAH)	75 mt.		164,45

POLİETİLEN SİYAH YER ALTI BORULAR - 750N

001 165 410014 00 11	14/10 ATÜ POLİETİLEN BORU (SİYAH)	100 mt.		8,22
001 165 410016 00 11	16/10 ATÜ POLİETİLEN BORU (SİYAH)	100 mt.		9,87
001 165 410018 00 11	18/10 ATÜ POLİETİLEN BORU (SİYAH)	100 mt.		12,02
001 165 410020 00 11	20/10 ATÜ POLİETİLEN BORU (SİYAH)	100 mt.		15,18
001 165 410025 00 11	25/10 ATÜ POLİETİLEN BORU (SİYAH)	100 mt.		18,34
001 165 410032 00 11	32/10 ATÜ POLİETİLEN BORU (SİYAH)	100 mt.		27,83
001 165 410037 00 11	37/10 ATÜ POLİETİLEN BORU (SİYAH)	100 mt.		37,95
001 165 410040 00 11	40/10 ATÜ POLİETİLEN BORU (SİYAH)	100 mt.		45,54
001 165 410050 00 11	50/10 ATÜ POLİETİLEN BORU (SİYAH)	100 mt.		65,78
001 165 410063 00 11	63/10 ATÜ POLİETİLEN BORU (SİYAH)	100 mt.		93,61
001 165 410075 00 11	75/10 ATÜ POLİETİLEN BORU (SİYAH)	100 mt.		111,32
001 165 410090 00 11	90/10 ATÜ POLİETİLEN BORU (SİYAH)	100 mt.		189,75
001 165 410100 00 11	100/10 ATÜ POLİETİLEN BORU (SİYAH)	100 mt.		227,7
001 165 410110 00 11	110/10 ATÜ POLİETİLEN BORU (SİYAH)	75 mt.		253



001 046 130107 00 11



001 046 170102 00 11



001 046 130101 00 11



001 046 170101 00 11



001 046 000001 00 11



001 046 131201 00 12

001 046 161201 00 12



001 046 131202 00 12

001 046 120101 00 12



001 046 120103 00 12



001 046 120100 00 12



001 046 131201 00 12

001 046 161201 00 12



000 700 000215 00 12

000 700 000214 00 14



000 700 000036 00 14

000 700 000035 00 12



000 700 000039 00 12

000 700 000256 00 12



001 046 000103 00 00

001 046 000103 00 11



001 046 021212 00 11



Ürün Kodu	Ürün Adı	Kutu Mt./Ad.	Koli Adet	Fiyat (₺)
PLASTİK KASA - BUAT - TAKOZLAR				
001 046 130102 00 11	NORM KASA	100 ad.	1000	2,85
001 046 130101 00 11	NORM BUAT (14-18 ÇIKIŞLI)	50 ad.	500	6,55
001 046 130105 00 11	NORM BUAT KAPAKSIZ	50 ad.	500	4,84
001 046 160102 00 11	GEÇMELİ PLASTİK KASA	100 ad.	400	11,31
001 046 160101 00 11	GEÇMELİ DERİN KASA	100 ad.	500	5,45
001 046 130107 00 11	GEÇMELİ DERİN KASA KAPAKSIZ	100 ad.	500	4,08
001 046 120101 00 11	ALÇIPAN KASA 1'Lİ	75 ad.	300	13,26
001 046 120102 00 11	ALÇIPAN KASA 2'Lİ	50 ad.	200	19,95
001 046 120103 00 11	ALÇIPAN KASA 3'Lİ	25 ad.	100	29,15
001 046 120100 00 11	GEÇMELİ ALÇ.KASA SİYAH	50 ad.	300	8,64
001 046 170101 00 11	TÜNEL KASA	100 ad.	500	19,37
001 046 170102 00 11	TÜNEL BUAT	50 ad.	300	12,37
001 046 000001 00 11	PLASTİK TAKOZ (14-18 ÇIKIŞLI)	100 ad.	1000	4,67
TURUNCU KASA VE BUATLAR - HALOJEN FREE - ALEV YAYMAYAN				
001 046 131202 00 12	NORM KASA (TURUNCU) (H.FREE) (ALEV YAYMAYAN)	100 ad.	1000	7,68
001 046 131201 00 12	NORM BUAT (TURUNCU) (H.FREE) (ALEV YAYMAYAN)	50 ad.	500	13,57
001 046 161201 00 12	GEÇMELİ DERİN KASA (TURUNCU) (H.FREE) (ALEV YAYMAYAN)	100 ad.	500	13,57
TURUNCU KASA VE BUATLAR - HALOJEN FREE - ALEV YAYAN				
001 046 130202 00 12	NORM KASA (TURUNCU) (H.FREE) (ALEV YAYAN)	100 ad.	1000	6,78
001 046 130201 00 12	NORM BUAT (TURUNCU) (H.FREE) (ALEV YAYAN)	50 ad.	500	12,33
001 046 160201 00 12	GEÇMELİ DERİN KASA (TURUNCU) (H.FREE) (ALEV YAYAN)	100 ad.	500	12,33
TURUNCU KASA VE BUATLAR - ALEV YAYAN				
001 046 130102 00 12	NORM KASA (TURUNCU)(ALEV YAYAN)	100 ad.	1000	4,72
001 046 130101 00 12	NORM BUAT (TURUNCU)(ALEV YAYAN)	50 ad.	500	9,44
001 046 160102 00 12	GEÇMELİ PLASTİK KASA (TURUNCU)(ALEV YAYAN)	100 ad.	400	12,07
001 046 160101 00 12	GEÇMELİ DERİN KASA (TURUNCU)(ALEV YAYAN)	100 ad.	500	12,5
001 046 170101 00 12	TÜNEL KASA (TURUNCU)(ALEV YAYAN)	100 ad.	500	18,97
001 046 170102 00 12	TÜNEL BUAT (TURUNCU)(ALEV YAYAN)	50 ad.	300	13,6
001 046 120101 00 12	ALÇIPAN KASA 1'Lİ (TURUNCU)(ALEV YAYAN)	75 ad.	300	13,91
001 046 120102 00 12	ALÇIPAN KASA 2'Lİ (TURUNCU)(ALEV YAYAN)	50 ad.	200	21,1
001 046 120103 00 12	ALÇIPAN KASA 3'LÜ (TURUNCU)(ALEV YAYAN)	25 ad.	100	30,65
001 046 120100 00 12	GEÇMELİ ALÇIPAN KASA (TURUNCU)(ALEV YAYAN)	50 ad.	300	10,8
TURUNCU KASA VE BUATLAR - ALEV YAYMAYAN				
001 046 131102 00 12	NORM KASA (TURUNCU)(ALEV YAYMAYAN)	100 ad.	1000	5,83
001 046 131101 00 12	NORM BUAT (TURUNCU)(ALEV YAYMAYAN)	50 ad.	500	11,1
001 046 161102 00 12	GEÇMELİ PLASTİK KASA (TURUNCU)(ALEV YAYMAYAN)	100 ad.	400	15,58
001 046 161101 00 12	GEÇMELİ DERİN KASA (TURUNCU)(ALEV YAYMAYAN)	100 ad.	500	15,36
001 046 210002 00 12	TÜNEL KASA (TURUNCU)(ALEV YAYMAYAN)	100 ad.	500	25,12
001 046 210003 00 12	TÜNEL BUAT (TURUNCU)(ALEV YAYMAYAN)	50 ad.	300	18,32
001 046 121101 00 12	ALÇIPAN KASA 1'Lİ (TURUNCU)(ALEV YAYMAYAN)	75 ad.	300	16,97
001 046 121102 00 12	ALÇIPAN KASA 2'Lİ (TURUNCU)(ALEV YAYMAYAN)	50 ad.	200	26,24
001 046 121103 00 12	ALÇIPAN KASA 3'LÜ (TURUNCU)(ALEV YAYMAYAN)	25 ad.	100	37,02
001 046 121100 00 12	GEÇMELİ ALÇIPAN KASA (TURUNCU)(ALEV YAYMAYAN)	50 ad.	300	13,57
BETON DUVAR ANAHTAR KASALARI - ALEV YAYAN				
000 700 000037 00 14	BUAT ARKA KAPAK SARI (ALEV YAYAN)	50 ad.	500	3,79
000 700 000035 00 12	BUAT GÖVDE 60'LİK TURUNCU (ALEV YAYAN)	50 ad.	350	7,78
000 700 000256 00 14	KALIBA TESPİT ELEMANI SARI (ALEV YAYAN)		250	4,99
000 700 000039 00 12	SİĞ BRÜT ANAH. KASASI TURUNCU (ALEV YAYAN)	100 ad.	500	13,47
000 700 000036 00 14	KONİK GÖVDE SARI (ALEV YAYAN)	50 ad.	250	7,6
000 700 000214 00 14	APLİK 20'LİK SARI (ALEV YAYAN)	100 ad.	1000	3,47
000 700 000215 00 12	APLİK EĞİK BAĞLANTI DIRSEĞİ TURUNCU (ALEV YAYAN)	100 ad.	1000	3,29
BETON DUVAR ANAHTAR KASALARI - ALEV YAYMAYAN				
000 700 200037 00 14	BUAT ARKA KAPAK SARI (ALEV YAYMAYAN)	50 ad.	500	4,91
000 700 200035 00 12	BUAT GÖVDE 60'LİK TURUNCU (ALEV YAYMAYAN)	50 ad.	350	9,98
000 700 200256 00 14	KALIBA TESPİT ELEMANI SARI (ALEV YAYMAYAN)		250	7,16
000 700 200039 00 12	SİĞ BRÜT ANAH. KASASI TURUNCU (ALEV YAYMAYAN)	100 ad.	500	22,28
000 700 200036 00 14	KONİK GÖVDE SARI (ALEV YAYMAYAN)	50 ad.	250	9,88
000 700 200214 00 14	APLİK 20'LİK SARI (ALEV YAYMAYAN)	100 ad.	1000	3,62
000 700 200215 00 12	APLİK EĞİK BAĞLANTI DIRSEĞİ TURUNCU (ALEV YAYMAYAN)	100 ad.	1000	5,65
KARE BUAT				
001 046 021010 00 11	10X10 KARE BUAT (SİYAH)	10 ad.	300	50,71
001 046 021212 00 11	12X12 KARE BUAT (SİYAH)	10 ad.	200	53,19
001 046 021515 00 11	15X15 KARE BUAT (SİYAH)	10 ad.	120	79,79
001 046 022020 00 11	20X20 KARE BUAT (SİYAH)	10 ad.	70	99,07
001 046 000103 00 11	ANTİGRON BUAT 3'LÜ PLASTİK (SİYAH)	10 ad.	240	36,7
001 046 000104 00 11	ANTİGRON BUAT 4'LÜ PLASTİK (SİYAH)	10 ad.	240	43,06
001 046 000103 00 00	ANTİGRON BUAT 3'LÜ PLASTİK (BEYAZ)	10 ad.	240	37,01
001 046 000104 00 00	ANTİGRON BUAT 4'LÜ PLASTİK (BEYAZ)	10 ad.	240	44,02

Ürün Kodu	Ürün Adı	Kutu Mt./Ad.	Koli Adet	Fiyat (₺)
TURUNCU KARE BUAT				
001 046 021010 00 12	10X10 KARE BUAT TURUNCU	10 ad.	300	51,21
001 046 021212 00 12	12X12 KARE BUAT TURUNCU	10 ad.	200	56,23
001 046 021515 00 12	15X15 KARE BUAT TURUNCU	10 ad.	120	81,52
001 046 022020 00 12	20X20 KARE BUAT TURUNCU	10 ad.	70	103,57
001 046 000103 00 12	ANTİGRON BUAT 3'LÜ TURUNCU	10 ad.	240	37,06
001 046 000104 00 12	ANTİGRON BUAT 4'LÜ TURUNCU	10 ad.	240	42,82



001 046 021212 00 12

TURUNCU KARE BUAT - ALEV YAYMAYAN				
001 046 051010 00 12	KARE BUAT TURUNCU(10X10) (A.YAYMAYAN)	10 ad.	300	56,38
001 046 051212 00 12	KARE BUAT TURUNCU(12X12) (A.YAYMAYAN)	10 ad.	200	60,59
001 046 051515 00 12	KARE BUAT TURUNCU(15X15) (A.YAYMAYAN)	10 ad.	120	94,75
001 046 052020 00 12	KARE BUAT TURUNCU(20X20) (A.YAYMAYAN)	10 ad.	70	124,49



000 700 000047 00 00

LÜKS BUAT KAPAKLARI				
126 046 180001	LÜKS BUAT KAPAĞI(BOMBELİ-PLS. AYAK)	100 ad.	1000	3,81
126 046 180003	LÜKS BUAT KAPAĞI(DÜZ PLS. AYAK)	100 ad.	1000	4,13
126 046 180004	LÜKS BUAT KAPAĞI(BOMB.PLS.AYAK)VIDALI	100 ad.	1000	8,85



126 046 180003

KARE BUAT KAPAKLARI				
000 700 000043 00 00	10X10 KARE BUAT KAPAĞI	1 ad.	300	12,2
000 700 000045 00 00	12X12 KARE BUAT KAPAĞI	1 ad.	350	15,35
000 700 000047 00 00	15X15 KARE BUAT KAPAĞI	1 ad.	260	21,75
000 700 000049 00 00	20X20 KARE BUAT KAPAĞI	1 ad.	140	39,58

126 046 180001 126 046 180004

MUTLUSAN BETON ÇİVİLİ KROŞELER					
032 048 070000	NO:0 BETON ÇİVİLİ KROŞE(0.75 YASSIKORD.)	MUTLUSAN	1000 ad.	20000	0,31
032 048 070001	NO:1 BETON ÇİVİLİ KROŞE(0.75 YASSIKORD.)	MUTLUSAN	1000 ad.	20000	0,31
032 048 070002	NO:2 BETON ÇİVİLİ KROŞE(0.75 YASSIKORD.)	MUTLUSAN	1000 ad.	20000	0,31
032 048 070003	NO:3 BETON ÇİVİLİ KROŞE (2X1.5-3X1.5)	MUTLUSAN	1000 ad.	20000	0,45
032 048 070004	NO:4 BETON ÇİVİLİ KROŞE (2X4)	MUTLUSAN	1000 ad.	20000	0,47
032 048 070005	NO:5 BETON ÇİVİLİ KROŞE (2X4-4X4)	MUTLUSAN	1000 ad.	10000	0,65
032 048 070006	NO:6 BETON ÇİVİLİ KROŞE (2X6)	MUTLUSAN	1000 ad.	10000	0,65
032 048 070007	NO:7 BETON ÇİVİLİ KROŞE (4X10)	MUTLUSAN	1000 ad.	5000	1,29
032 048 070008	NO:8 BETON ÇİVİLİ KROŞE (3X16+10)	MUTLUSAN	800 ad.	3200	1,61



GALVANİZLİ SAC KROŞELER					
001 048 060001 00 00	NO. 1 TEKLI GALVANİZ SAC KROŞE 12MM		1500 ad.		1,81
001 048 060002 00 00	NO. 2 TEKLI GALVANİZ SAC KROŞE 14MM		1000 ad.		1,98
001 048 060003 00 00	NO. 3 TEKLI GALVANİZ SAC KROŞE 17MM		700 ad.		2,12
001 048 060004 00 00	NO. 4 TEKLI GALVANİZ SAC KROŞE 20MM		500 ad.		2,21
001 048 060007 00 00	NO. 7 TEKLI GALVANİZ SAC KROŞE 26MM		350 ad.		2,76
001 048 060008 00 00	NO. 8 TEKLI GALVANİZ SAC KROŞE 34MM		250 ad.		7,05
001 048 060009 00 00	NO. 9 TEKLI GALVANİZ SAC KROŞE 43MM		200 ad.		7,92
001 048 060010 00 00	NO. 10 TEKLI GALVANİZ SAC KROŞE 53MM		150 ad.		8,43
001 048 060011 00 00	NO. 11 TEKLI GALVANİZ SAC KROŞE 55MM		120 ad.		9,69
001 048 070002 00 00	NO. 2 ÇİFTLİ GALVANİZ SAC KROŞE 13MM		600 ad.		2,05
001 048 070003 00 00	NO. 3 ÇİFTLİ GALVANİZ SAC KROŞE 16MM		500 ad.		2,4
001 048 070004 00 00	NO. 4 ÇİFTLİ GALVANİZ SAC KROŞE 22MM		400 ad.		2,42
001 048 070007 00 00	NO. 7 ÇİFTLİ GALVANİZ SAC KROŞE 25MM		400 ad.		2,92
001 048 070008 00 00	NO. 8 ÇİFTLİ GALVANİZ SAC KROŞE 35MM		300 ad.		7,36
001 048 070009 00 00	NO. 9 ÇİFTLİ GALVANİZ SAC KROŞE 45MM		200 ad.		8,87
001 048 070010 00 00	NO. 10 ÇİFTLİ GALVANİZ SAC KROŞE 50MM		150 ad.		9,39
001 048 070011 00 00	NO. 11 ÇİFTLİ GALVANİZ SAC KROŞE 55MM		100 ad.		9,85



RAY KROŞE VE TANDIR KROŞELER					
035 048 100001	NO. 1 RAY KROŞE (2X1.5-4X2.5)		350 ad.		4,98
035 048 100002	NO. 2 RAY KROŞE (4X4-4X16)		250 ad.		5,65
001 025 010100 00 00	GALVANİZ KROŞE RAYI (1M)		50 ad.		64,41
035 048 110001	NO. 1 TANDIR KROŞE (2X1.5-2X6)		350 ad.		5,32
035 048 110002	NO. 2 TANDIR KROŞE (4X6)		250 ad.		5,32
035 048 110003	NO. 3 TANDIR KROŞE (4X10)		250 ad.		5,32
035 048 110004	NO. 4 TANDIR KROŞE (4X16)		150 ad.		6,77
035 048 110005	NO. 5 TANDIR KROŞE (3X25+16)		150 ad.		6,77



001 053 000001 00 00

001 053 000002 00 00

PLASTİK DÜBELLER					
016 053 000014	BURGULU ALÇIPAN DÜBELİ (YENİ)		100 ad.	10000	0,68
001 053 000001 00 00	ALÇIPAN DÜBEL		100 ad.	15000	0,45
001 053 000002 00 00	KANAL DÜBELİ		1000 ad.	14000	0,36
016 053 000006	6 MM BEYAZ DÜBEL		1000 ad.	35000	0,13
016 053 000007	7 MM BEYAZ DÜBEL		1000 ad.	25000	0,16
016 053 000008	8 MM BEYAZ DÜBEL		1000 ad.	20000	0,21



16 053 000014

DÜBELLİ KROŞELER					
001 048 090002 00 17	3/13 TEKLI KABLO KROŞESİ		500 ad.	10000	0,59
001 048 090006 00 17	8/28 TEKLI KABLO KROŞESİ		500 ad.	5000	0,69
001 048 090001 00 00	ÇİFTLİ KABLO KROŞESİ (20'LİK)		100 ad.	2500	0,82
001 048 090002 00 00	ÇİFTLİ KABLO KROŞESİ (25'LİK)		100 ad.	2500	0,88
001 048 090003 00 17	16'LİK BORU KELEPÇESİ		100 ad.	2000	0,71
001 048 090004 00 17	20'LİK BORU KELEPÇESİ		100 ad.	1500	1,26
001 048 090005 00 17	25'LİK BORU KELEPÇESİ		100 ad.	1000	1,76



BORU GEÇME TOPRAKLAMA ÇUBUĞU					
091 025 011610	TOP ÇUBUĞU BORU GEÇMELİ 16 MM 1 MT		10 ad.		356,52
091 025 011615	TOP ÇUBUĞU BORU GEÇMELİ 16 MM 1,5 MT		10 ad.		534,78
091 025 012010	TOP ÇUBUĞU BORU GEÇMELİ 20 MM 1 MT		5 ad.		546,66
091 025 012015	TOP ÇUBUĞU BORU GEÇMELİ 20 MM 1,5 MT		5 ad.		784,34





Ürün Kodu	Ürün Adı	Kutu Mt./Ad.	Koli Adet	Fiyat (₺)
-----------	----------	--------------	-----------	-----------

AKILLI KAPI KİLİDİ

027 112 000010	AKILLI KAPI KİLİDİ	1 ad.		1897,5
027 112 000011	KAPI KONTROL SİSTEMİ 500 HAFIZALI TUŞLU	1 ad.		948,75
027 112 000012	KAPI KONTROL SİSTEMİ 1000 HAFIZALI KARTLI METAL GÜVDE	1 ad.		1716,79

KAPI VE MERDİVEN OTOMATIĞI

027 112 000001	GİZLİ KAPI OTOMATIĞI (DOKUNMATİK)	1 ad.	20	469,86
027 112 000002	GİZLİ KAPI OTOMATIĞI (BASMATİK)	1 ad.	20	469,86
027 112 000007	ELEK. KİLİTLİ (ANAHTARLI) KAPI OTOMATIĞI	1 ad.	12	971,34
027 112 000009	ELEKTRİKLİ KİLİTLİ KAPI OTOMATIĞI (BİLYELİ)	1 ad.	12	971,34
027 112 000003	BUTONLU KAPI OTOMATIĞI	1 ad.	30	352,39
028 112 000004	KAPI OTOMATIĞI (NORMAL)	1 ad.	30	338,84
027 112 000004	BAS-AÇ KAPI OTOMATIĞI (TİRAJLI KİLİT İÇİN)	1 ad.		496,96
027 112 000005	MERDİVEN OTOMATIĞI (RAYLI)	1 ad.	30	338,84
027 112 000006	MERDİVEN OTOMATIĞI (NORMAL)	1 ad.	30	338,84

ZİL BUTONU ÇEŞİTLERİ

037 106 020001	1'Lİ ALÜMİNYUM ZİL BUTONU 1.KALİTE	1 ad.	100	42,92
037 106 020002	2'Lİ ALÜMİNYUM ZİL BUTONU 1.KALİTE	1 ad.	66	85,84
037 106 020003	3'LÜ ALÜMİNYUM ZİL BUTONU 1.KALİTE	1 ad.	56	128,76
037 106 020004	4'LÜ ALÜMİNYUM ZİL BUTONU 1.KALİTE	1 ad.	43	171,68
037 106 020005	5'Lİ ALÜMİNYUM ZİL BUTONU 1.KALİTE	1 ad.	36	214,6
037 106 020006	6'Lİ ALÜMİNYUM ZİL BUTONU 1.KALİTE	1 ad.	32	257,52
037 106 020007	7'Lİ ALÜMİNYUM ZİL BUTONU 1.KALİTE	1 ad.	28	300,44
037 106 020008	8'Lİ ALÜMİNYUM ZİL BUTONU 1.KALİTE	1 ad.	20	343,36
037 106 020009	9'LU ALÜMİNYUM ZİL BUTONU 1.KALİTE	1 ad.	20	386,28
037 106 020010	10'LU ALÜMİNYUM ZİL BUTONU 1.KALİTE	1 ad.	20	429,2

ZİLLER VE ZİL TRAFOLARI

027 105 010012	ZİL TRAFOSU 12 V	1 ad.	80	171,68
027 105 010015	ZİL TRAFOSU 15 V	1 ad.	40	325,29
028 105 020003	KAMPANA ZİL 220 V	1 ad.	24	948,75
028 105 020004	KAMPANA ZİL 12V, 24V, 110V	1 ad.	24	1219,82
028 105 020000	MUNZAM ZİL ROLESİ	1 ad.	100	587,32
018 105 000006	KANARYA ZİL (TEK SES)	1 ad.	50	86,74
018 105 000007	KANARYA ZİL (ÜÇ SES)	1 ad.	50	108,43
018 105 000001	TELEFON ZİLİ (AYARLI)	1 ad.	50	158,13
018 105 000002	DİNG DONG ZİL ELEKTRONİK (3 SES)	1 ad.	50	119,27

TELEFON DAĞITIM KUTULARI ve AKSESUARLARI

001 049 001020 00 17	TLF. DĞT. KUTUSU (10 - 20) BOŞ PLS. KLT	2 ad.	60	227,24
001 049 201020 00 17	TLF.DĞT.KUTUSU(10-20)BOŞ PLS.(KİLİTLİ) (A. YAYMAYAN)	2 ad.	60	286,24
001 049 011020 00 17	TLF. DĞT. KUTUSU (10 - 20) BOŞ KİLİTLİ	2 ad.	60	321,69
001 049 211020 00 17	TLF.DĞT.KUTUSU(10-20)BOŞ(KİLİTLİ) (A. YAYMAYAN)	2 ad.	60	389,9
001 049 001050 00 17	TLF. DĞT. KUTUSU(10-50) BOŞ PLS.KİLİT	1 ad.	28	321,12
001 049 201050 00 17	TLF.DĞT.KUTUSU(10-50)BOŞ PLS.(KİLİTLİ) (A. YAYMAYAN)	1 ad.	28	475,3
001 049 011050 00 17	TLF. DĞT. KUTUSU(10-50) KİLİTLİ	1 ad.	28	415,8
001 049 211050 00 17	TLF.DĞT.KUTUSU(10-50)(KİLİTLİ) (A. YAYMAYAN)	1 ad.	28	462,02
001 024 000001 00 00	ÇATI (1 MODÜL İÇİN)	1 ad.	1000	21,87
001 024 000002 00 00	ÇATI (2 MODÜL İÇİN)	1 ad.	500	43,73
001 024 000003 00 00	ÇATI (3 MODÜL İÇİN)	1 ad.	400	65,60
001 024 000004 00 00	ÇATI (4 MODÜL İÇİN)	1 ad.	300	87,47
001 024 000005 00 00	ÇATI (5 MODÜL İÇİN)	1 ad.	200	109,33
001 024 000010 00 00	ÇATI (10 MODÜL İÇİN)	1 ad.	100	218,66
888 049 050001	KESMESİZ MODÜL	10 ad.	250	4,52 \$
888 049 050002	KESMELİ MODÜL	10 ad.	250	5,42 \$
888 049 050003	İRTİBATLAMA ALETİ	1 ad.	50	13,55 \$



TELEFON DAĞITIM KUTULARI



	ÜRÜN KODU	888 038 218000
	ÜRÜN ADI	Q218 KABLOSUZ KAPI ZİLİ LEDLİ 100 MT. - 32 MELODİ
	AMB. AD./KOLİ	1 Ad. / 10
	FİYAT	33,45 \$

	ÜRÜN KODU	018 105 114800
	ÜRÜN ADI	A-148 KAPI ZİLİ - 32 MELODİ
	AMB. AD./KOLİ	1 Ad. / 10
	FİYAT	21,34 \$

	ÜRÜN KODU	018 105 158100
	ÜRÜN ADI	X-581 KAPI ZİLİ - 32 MELODİ
	AMB. AD./KOLİ	1 Ad. / 10
	FİYAT	22,33 \$

	ÜRÜN KODU	018 105 162811
	ÜRÜN ADI	WA-628 KAPI ZİLİ - SİYAH 32 MELODİ
	AMB. AD./KOLİ	10/200
	FİYAT	29,68 \$

	ÜRÜN KODU	018 105 162800
	ÜRÜN ADI	WA-628 KAPI ZİLİ BEYAZ 32 MELODİ
	AMB. AD./KOLİ	1 Ad. / 10
	FİYAT	29,68 \$

	ÜRÜN KODU	018 105 163811
	ÜRÜN ADI	WA-638 KAPI ZİLİ - SİYAH 32 MELODİ
	AMB. AD./KOLİ	1 Ad. / 10
	FİYAT	29,68 \$

	ÜRÜN KODU	018 105 163800
	ÜRÜN ADI	WA-638 KAPI ZİLİ BEYAZ 32 MELODİ
	AMB. AD./KOLİ	1 Ad. / 10
	FİYAT	29,68 \$

YANGIN
ALGILAMA
ve İKAZ
SİSTEMLERİ



Kod	Ürün Adı	Kutu Mt./Ad.	Koli Adet	Fiyat (₺)
İKAZ KORNASI CE				
026 112 010001	İKAZ KORNASI 220 V	1 ad.	45 ad.	370,46
028 120 000001	İKAZ BUTONU (KARE)	2 ad.	90 ad.	112,95
ALARM KORNA ve YANGIN İHBAR BUTONU CE				
010 090 050050	RESELENEBİLİR BUTON	2 ad.		519,55
010 090 050051	RESELENEBİLİR BUTON (KAPAKLI)	1 ad.		564,73
028 120 010006	ALARM KORNA PLASTİK	1 ad.		542,14
028 120 010005	ALARM KORNA DÖKÜM	1 ad.		609,91
SİRENLER				
102 111 000012	LEDLİ FLAŞÖRLÜ ELEKTRONİK SİREN 12V	1 ad.		283,5
102 111 000024	LEDLİ FLAŞÖRLÜ ELEKTRONİK SİREN 24V	1 ad.		283,5
102 111 000220	LEDLİ FLAŞÖRLÜ ELEKTRONİK SİREN 220V	1 ad.		302,7
102 111 000221	LEDLİ FLAŞÖRLÜ ELEKTRONİK SİREN 220V. (YENİ MODEL)	1 ad.		519,55
888 111 050004	MS190 MİNİ SİREN (105 db)	1 ad.		38,07 \$
026 111 010001	AS. 1 MOTORLU SİREN (PLS. GÖV.)220V,100W (110 db.)	1 ad.		1.287,59
026 111 010002	AS. 2 MOTORLU SİREN (PLS.GÖV.)220V,100W (117 db.)	1 ad.		1.445,71
026 111 010003	AS. 1 MOTORLU SİREN (METAL.GÖV.)220V,100W (115 db.)	CE	1 ad.	1.626,43
026 111 010004	AS. 2 MOTORLU SİREN (METAL.GÖV.)220V,100W (120 db.)	CE	1 ad.	1.987,86
026 111 010005	AS.3 MOTORLU SİREN 220V-280W (130 db.)	CE	1 ad.	10.165,18



MUTLUSAN ASPIRATÖR ÇEŞİTLERİ



100 mm

Çalışma Akımı Operation Voltage	220-240V / 50-60Hz
Emiş Hacmi Airflow	100m ³ /h
Devir Hız Round Speed	2450 rpm
Ses Voice	43 dB
Güç Power	12W

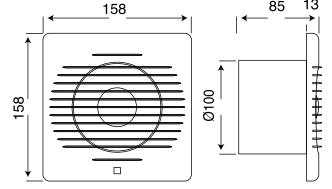

ÜRÜN KODU	: 001 111 000100 00 00
ÜRÜN ADI	: MUTLUSAN 100 ASPIRATÖR
AMBALAJ ADET / KOLİ	: 1 / 20
FİYAT (₺)	: 295,67



120 mm

Çalışma Akımı Operation Voltage	220-240V / 50-60Hz
Emiş Hacmi Airflow	120m ³ /h
Devir Hız Round Speed	1900 rpm
Ses Voice	47 dB
Güç Power	15W

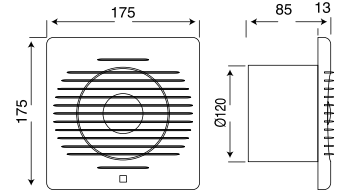

ÜRÜN KODU	: 001 111 000120 00 00
ÜRÜN ADI	: MUTLUSAN 120 ASPIRATÖR
AMBALAJ ADET / KOLİ	: 1 / 20
FİYAT (₺)	: 310,86



150 mm

Çalışma Akımı Operation Voltage	220-240V / 50-60Hz
Emiş Hacmi Airflow	150m ³ /h
Devir Hız Round Speed	1350 rpm
Ses Voice	47 dB
Güç Power	20W

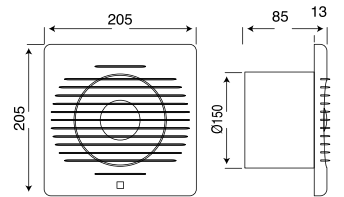

ÜRÜN KODU	: 001 111 000150 00 00
ÜRÜN ADI	: MUTLUSAN 150 ASPIRATÖR
AMBALAJ ADET / KOLİ	: 1 / 16
FİYAT (₺)	: 418,27



200 mm

Çalışma Akımı Operation Voltage	220-240V / 50-60Hz
Emiş Hacmi Airflow	200m ³ /h
Devir Hız Round Speed	1000 rpm
Ses Voice	47 dB
Güç Power	40W

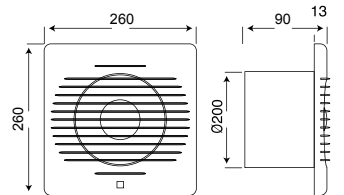

ÜRÜN KODU	: 001 111 000200 00 00
ÜRÜN ADI	: MUTLUSAN 200 ASPIRATÖR
AMBALAJ ADET / KOLİ	: 1 / 6
FİYAT (₺)	: 845,42

ME-FAN ASPIRATÖR ÇEŞİTLERİ



100 mm

Çalışma Akımı Operation Voltage	220-240V / 50-60Hz
Emiş Hacmi Airflow	100m ³ /h
Devir Hız Round Speed	2450 rpm
Ses Voice	43 dB
Güç Power	12W

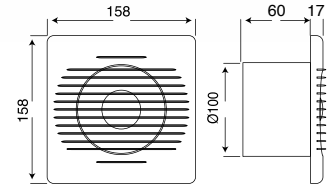

ÜRÜN KODU	: 001 211 000100 00 00
ÜRÜN ADI	: MUTLUSAN ME-FAN 100 ASPIRATÖR
AMBALAJ ADET / KOLİ	: 1 / 20
FİYAT (₺)	: 271,07



120 mm

Çalışma Akımı Operation Voltage	220-240V / 50-60Hz
Emiş Hacmi Airflow	120m ³ /h
Devir Hız Round Speed	1900 rpm
Ses Voice	47 dB
Güç Power	15W

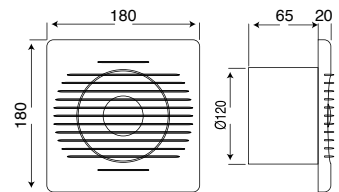

ÜRÜN KODU	: 001 211 000120 00 00
ÜRÜN ADI	: MUTLUSAN ME-FAN 120 ASPIRATÖR
AMBALAJ ADET / KOLİ	: 1 / 20
FİYAT (₺)	: 286,88



150 mm

Çalışma Akımı Operation Voltage	220-240V / 50-60Hz
Emiş Hacmi Airflow	150m ³ /h
Devir Hız Round Speed	1350 rpm
Ses Voice	47 dB
Güç Power	20W

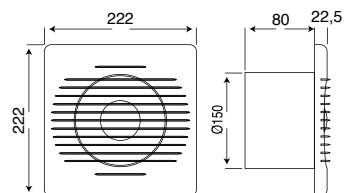

ÜRÜN KODU	: 001 211 000150 00 00
ÜRÜN ADI	: MUTLUSAN ME-FAN 150 ASPIRATÖR
AMBALAJ ADET / KOLİ	: 1 / 12
FİYAT (₺)	: 374,98



MUTLUSAN ASPIRATÖR ÇEŞİTLERİ

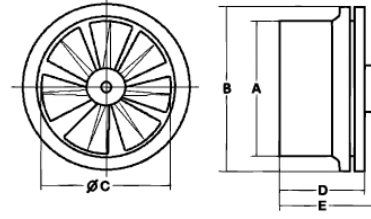

Ürün Kodu	Ürün Adı	Güç Watt	Hız Devir/Dk	Debi m ³ /h	A	B	C	D	E	Adet	Fiyat (₺)
080 088 160160	MB160MM BACA ASPIRATÖR	40	1300	400	160	210	154	85	110	1	1.519,81
080 088 160200	MB200MM BACA ASPIRATÖR	40	1300	650	200	265	194	85	110	1	1.703,23
080 088 160250	MB250MM BACA ASPIRATÖR	50	1300	800	240	305	224	110	125	1	1.886,66
080 088 160300	MB300MM BACA ASPIRATÖR	60	1300	1000	295	365	284	110	125	1	2.227,3

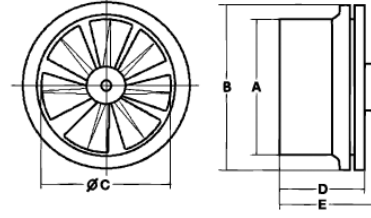

Ürün Kodu	Ürün Adı	Güç Watt	Hız Devir/Dk	Debi m ³ /h	A	B	C	D	E	Adet	Fiyat (₺)
080 088 200160	MK160MM KAPAKLI ASPIRATÖR	40	1300	400	160	210	154	85	110	1	1.624,62
080 088 200200	MK200MM KAPAKLI ASPIRATÖR	40	1300	650	200	265	194	85	110	1	1.834,25
080 088 200250	MK250MM KAPAKLI ASPIRATÖR	50	1300	800	240	305	224	110	125	1	2.096,29
080 088 200300	MK300MM KAPAKLI ASPIRATÖR	60	1300	1000	295	365	284	110	125	1	2.436,93

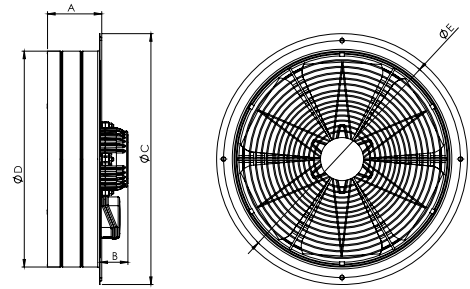

Ürün Kodu	Ürün Adı	Güç Watt	Hız Devir/Dk	Debi m ³ /h	A	B	C	D	E	Adet	Fiyat (₺)
080 088 002250	MSM250-2K MONOFAZE SANAYİ TİPİ ASPIRATÖR	180	2800	2400	114	61	304	251	277	1	3.406,46
080 088 000250	MSM250 MONOFAZE SANAYİ TİPİ ASPIRATÖR	125	1400	1200	114	61	304	251	277	1	3.406,46
080 088 000300	MSM300 MONOFAZE SANAYİ TİPİ ASPIRATÖR	125	1400	2200	114	61	390	325	360	1	3.930,54
080 088 000350	MSM350 MONOFAZE SANAYİ TİPİ ASPIRATÖR	155	1400	3200	114	61	435	374	405	1	4.192,57
080 088 000400	MSM400 MONOFAZE SANAYİ TİPİ ASPIRATÖR	180	1400	4100	114	61	485	427	455	1	4.585,63
080 088 000450	MSM450 MONOFAZE SANAYİ TİPİ ASPIRATÖR	220	1400	4800	114	61	546	470	516	1	4.978,68
080 088 000500	MSM500 MONOFAZE SANAYİ TİPİ ASPIRATÖR	250	1400	5200	125	61	590	518	560	1	5.502,75
080 088 000550	MSM550 MONOFAZE SANAYİ TİPİ ASPIRATÖR	280	1400	6000	130	160	624	560	595	1	7.599,49
080 088 000600	MSM600 MONOFAZE SANAYİ TİPİ ASPIRATÖR	290	1400	7500	130	160	674	610	645	1	6.550,89

Ürün Kodu	Ürün Adı	Güç Watt	Hız Devir/Dk	Debi m ³ /h	A	B	C	D	E	Adet	Fiyat (₺)
080 088 102250	MST250-2K TRİFAZE SANAYİ TİPİ ASPIRATÖR	180	2800	2400	114	61	304	251	277	1	3.406,46
080 088 100250	MST250 TRİFAZE SANAYİ TİPİ ASPIRATÖR	125	1400	1200	114	61	304	251	277	1	3.406,46
080 088 100300	MST300 TRİFAZE SANAYİ TİPİ ASPIRATÖR	125	1400	2200	114	61	390	325	360	1	3.930,54
080 088 100350	MST350 TRİFAZE SANAYİ TİPİ ASPIRATÖR	155	1400	3200	114	61	435	374	405	1	4.192,57
080 088 100400	MST400 TRİFAZE SANAYİ TİPİ ASPIRATÖR	180	1400	4100	114	61	485	427	455	1	4.585,63
080 088 100450	MST450 TRİFAZE SANAYİ TİPİ ASPIRATÖR	220	1400	4800	114	61	546	470	516	1	4.978,68
080 088 100500	MST500 TRİFAZE SANAYİ TİPİ ASPIRATÖR	250	1400	5200	125	61	590	518	560	1	5.502,75
080 088 100550	MST550 TRİFAZE SANAYİ TİPİ ASPIRATÖR	280	1400	6000	130	160	624	560	595	1	7.855,65
080 088 100600	MST600 TRİFAZE SANAYİ TİPİ ASPIRATÖR	290	1400	7500	130	160	674	610	645	1	6.550,89

LED ARMATÜR ÇEŞİTLERİ



IP65

ÜRÜN KODU	016 038 701100
ÜRÜN ADI	LEDLIGHT-1 LEDLİ ARMATÜR - BEYAZ
LÜMEN/WATT	1500Lm/15W
KELVIN	6400K
AMB. AD./KOLİ	30
FİYAT (₺)	186,65



IP65

ÜRÜN KODU	016 038 701111
ÜRÜN ADI	LEDLIGHT-1 LEDLİ ARMATÜR - SİYAH
LÜMEN/WATT	1500Lm/15W
KELVIN	6400K
AMB. AD./KOLİ	30
FİYAT (₺)	186,65

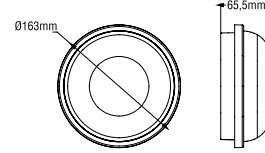
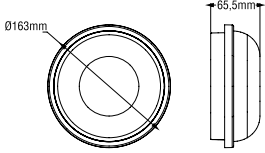



IP65

ÜRÜN KODU	016 038 701200
ÜRÜN ADI	LEDLIGHT-2 LEDLİ ARMATÜR - BEYAZ
LÜMEN/WATT	2000Lm/20W
KELVIN	6400K
AMB. AD./KOLİ	20
FİYAT (₺)	252,06

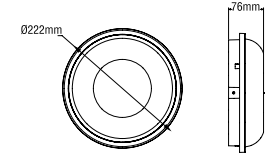
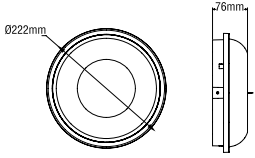

IP65

ÜRÜN KODU	016 038 701211
ÜRÜN ADI	LEDLIGHT-2 LEDLİ ARMATÜR - SİYAH
LÜMEN/WATT	2000Lm/20W
KELVIN	6400K
AMB. AD./KOLİ	20
FİYAT (₺)	252,06





IP65

ÜRÜN KODU	016 038 701300
ÜRÜN ADI	LEDLIGHT-3 LEDLİ ARMATÜR - BEYAZ
LÜMEN/WATT	1500Lm/15W
KELVIN	6400K
AMB. AD./KOLİ	30
FİYAT (₺)	186,65

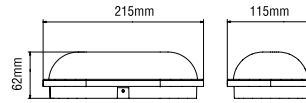
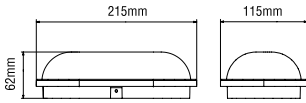

IP65

ÜRÜN KODU	016 038 701311
ÜRÜN ADI	LEDLIGHT-3 LEDLİ ARMATÜR - SİYAH
LÜMEN/WATT	1500Lm/15W
KELVIN	6400K
AMB. AD./KOLİ	30
FİYAT (₺)	186,65





IP65

ÜRÜN KODU	016 038 701400
ÜRÜN ADI	LEDLIGHT-4 LEDLİ ARMATÜR - BEYAZ
LÜMEN/WATT	2000Lm/20W
KELVIN	6400K
AMB. AD./KOLİ	20
FİYAT (₺)	252,06

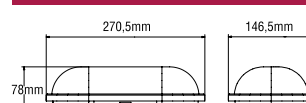
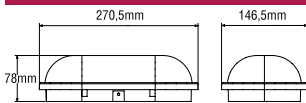

IP65

ÜRÜN KODU	016 038 701411
ÜRÜN ADI	LEDLIGHT-4 LEDLİ ARMATÜR - SİYAH
LÜMEN/WATT	2000Lm/20W
KELVIN	6400K
AMB. AD./KOLİ	20
FİYAT (₺)	252,06



RENK	BEYAZ	SİYAH
ÜRÜN KODU	016 038 701500	016 038 701511
ÜRÜN ADI	LED GLOP ARMATÜR IP20	
LÜMEN/WATT	2000Lm/20W	
KELVIN	6400K	
AMB. AD./KOLİ	24	
FİYAT (₺)	214,6	



ÜRÜN KODU	016 038 701522
ÜRÜN ADI	LED GLOP ARMATÜR KROM - IP20
LÜMEN/WATT	2000Lm/20W
KELVIN	6400K
AMB. AD./KOLİ	24
FİYAT (₺)	259,78

ARMATÜR ÇEŞİTLERİ

	ÜRÜN KODU	001 038 250021 00 00
	ÜRÜN ADI	360° SENSÖRLÜ TAVAN ARM. ACİL KİTLİ (2x25W) (PİL DAHİL)
	AMB. AD./KOLİ	1/12
	FİYAT (₺)	700,27

	ÜRÜN KODU	001 038 250022 00 00
	ÜRÜN ADI	360° SENSÖRLÜ TAVAN ARMATÜRÜ (2x25W)
	AMB. AD./KOLİ	1/12
	FİYAT (₺)	320,2

	ÜRÜN KODU	001 038 250052 00 00
	ÜRÜN ADI	360° SENSÖRLÜ TAVAN ARM. (2x25W) (TSE)
	AMB. AD./KOLİ	1/12
	FİYAT (₺)	480,3

	ÜRÜN KODU	888 888 000320
	ÜRÜN ADI	SLİM SENSÖRLÜ ARMATÜR LEDLİ ACİL KİTLİ(PİL)
	AMB. AD./KOLİ	1/24
	FİYAT (₺)	616,69

	ÜRÜN KODU	888 888 000319
	ÜRÜN ADI	SLİM SENSÖRLÜ ARMATÜR LEDLİ
	AMB. AD./KOLİ	1/24
	FİYAT (₺)	388,99

	ÜRÜN KODU	888 888 000322
	ÜRÜN ADI	SIVA ALTI SENSÖR MODÜLÜ
	AMB. AD./KOLİ	1/24
	FİYAT (₺)	246,68

	ÜRÜN KODU	888 888 000324
	ÜRÜN ADI	SIVA ÜSTÜ SENSÖR MODÜLÜ
	AMB. AD./KOLİ	1/36
	FİYAT (₺)	265,65

	ÜRÜN KODU	016 038 250085
	ÜRÜN ADI	ÇINAR DUVAR APLİK PLS, SOFT
	AMB. AD./KOLİ	1/24
	FİYAT (₺)	306,28

	ÜRÜN KODU	078 039 500100
	ÜRÜN ADI	SENSÖRLÜ DUVAR APLİK E-27 DUYULU
	AMB. AD./KOLİ	1/20
	FİYAT (₺)	316,25

ARMATÜR ÇEŞİTLERİ

	ÜRÜN KODU	001 038 050101 00 00
	ÜRÜN ADI	YASEMİN UFO KÜRE TAVAN ARMATÜR
	AMB. AD./KOLİ	12
	FİYAT (₺)	148,06

	ÜRÜN KODU	078 039 100006
	ÜRÜN ADI	ÇİFT DUYLU TAVAN ARMATÜR
	AMB. AD./KOLİ	2/32
	FİYAT (₺)	175,52

	ÜRÜN KODU	001 038 070101 00 00
	ÜRÜN ADI	YASEMİN UFO DÜZ TAVAN ARMATÜR
	AMB. AD./KOLİ	12
	FİYAT (₺)	147,55

	ÜRÜN KODU	001 038 010101 00 00
	ÜRÜN ADI	MANOLYA TAVAN ARMATÜR
	AMB. AD./KOLİ	1/5
	FİYAT (₺)	166,29

	ÜRÜN KODU	001 038 040101 00 00
	ÜRÜN ADI	YASEMİN UFO TAVAN ARMATÜR
	AMB. AD./KOLİ	12
	FİYAT (₺)	149,56

	ÜRÜN KODU	001 038 020101 00 00
	ÜRÜN ADI	FULYA TAVAN ARMATÜRÜ
	AMB. AD./KOLİ	1/5
	FİYAT (₺)	172,1

	ÜRÜN KODU	001 038 060101 00 00
	ÜRÜN ADI	YASEMİN KÜRE TAVAN ARMATÜR
	AMB. AD./KOLİ	12
	FİYAT (₺)	128,12

	ÜRÜN KODU	001 038 180101 00 00
	ÜRÜN ADI	AKASYA TAVAN ARMATÜRÜ
	AMB. AD./KOLİ	1/5
	FİYAT (₺)	169,92

	ÜRÜN KODU	001 038 030101 00 00
	ÜRÜN ADI	YASEMİN DÜZ TAVAN ARMATÜRÜ
	AMB. AD./KOLİ	12
	FİYAT (₺)	151,95

	ÜRÜN KODU	001 038 170101 00 00
	ÜRÜN ADI	KAMELYA TAVAN ARMATÜRÜ
	AMB. AD./KOLİ	1/5
	FİYAT (₺)	230,59

ARMATÜR ÇEŞİTLERİ

	ÜRÜN KODU	016 038 250086
	ÜRÜN ADI	İNCİ TAVAN ARMATÜR - BEYAZ
	AMB. AD./KOLİ	4/32
	FİYAT (₺)	119,72

	ÜRÜN KODU	016 038 250087
	ÜRÜN ADI	İNCİ TAVAN ARMATÜR - CEVİZ
	AMB. AD./KOLİ	4/32
	FİYAT (₺)	144,57

	ÜRÜN KODU	001 038 160101 00 00
	ÜRÜN ADI	YONCA TAVAN ARMATÜRÜ
	AMB. AD./KOLİ	48
	FİYAT (₺)	88,97

	ÜRÜN KODU	016 038 250090
	ÜRÜN ADI	YILDIZ TAVAN ARMATÜRÜ
	AMB. AD./KOLİ	8/64
	FİYAT (₺)	83,94

	ÜRÜN KODU	016 038 250088
	ÜRÜN ADI	İNCİ APLİK - DUVAR ARMATÜR - BEYAZ
	AMB. AD./KOLİ	4/64
	FİYAT (₺)	77,79

	ÜRÜN KODU	016 038 250089
	ÜRÜN ADI	İNCİ APLİK - DUVAR ARMATÜR - CEVİZ
	AMB. AD./KOLİ	4/64
	FİYAT (₺)	103,71

	ÜRÜN KODU	001 038 250017 00 00
	ÜRÜN ADI	BÜYÜK PAPATYA HAZIR ASKI TİJ TAKIMI
	AMB. AD./KOLİ	10/80
	FİYAT (₺)	43,31

	ÜRÜN KODU	001 038 250016 00 00
	ÜRÜN ADI	PAPATYA HAZIR ASKI TİJ TAKIMI
	AMB. AD./KOLİ	25/275
	FİYAT (₺)	31,47

	ÜRÜN KODU	001 038 250018 00 00
	ÜRÜN ADI	HAZIR ASKI TİJ TAKIMI
	AMB. AD./KOLİ	25/300
	FİYAT (₺)	30,38

	ÜRÜN KODU	016 038 250020
	ÜRÜN ADI	HAZIR ASKI TİJ TAKIMI (PLASTİK DUYLU)
	AMB. AD./KOLİ	25/500
	FİYAT (₺)	15,89

	ÜRÜN KODU	024 109 010005
	ÜRÜN ADI	YAĞMUR DUY (PLASTİK YANMAZ) E27
	AMB. AD./KOLİ	50
	FİYAT (₺)	20,87

ARMATÜR ÇEŞİTLERİ



	ÜRÜN KODU	016 038 250028
	ÜRÜN ADI	OVAL DÜZ ARMATÜR
	AMB. AD./KOLİ	8/48
	FİYAT (₺)	74,95



	ÜRÜN KODU	016 038 250029
	ÜRÜN ADI	OVAL KAFESLİ ARMATÜR
	AMB. AD./KOLİ	8/48
	FİYAT (₺)	77,75

	ÜRÜN KODU	016 038 250013
	ÜRÜN ADI	DUVAR APLİK (KRALİÇE)
	AMB. AD./KOLİ	4/48
	FİYAT (₺)	80,55

	ÜRÜN KODU	078 039 100005
	ÜRÜN ADI	NERGİS APLİK
	AMB. AD./KOLİ	8/64
	FİYAT (₺)	78,27

	ÜRÜN KODU	016 038 250031
	ÜRÜN ADI	TAVAN GLOP ARMATÜR (MINİ)
	AMB. AD./KOLİ	8/48
	FİYAT (₺)	60,06

	ÜRÜN KODU	001 038 120101 00 00
	ÜRÜN ADI	ORKİDE TAVAN ARMATÜRÜ
	AMB. AD./KOLİ	48
	FİYAT (₺)	77,28

	ÜRÜN KODU	001 038 020201 00 00
	ÜRÜN ADI	FULYA DUVAR APLİK
	AMB. AD./KOLİ	2/20
	FİYAT (₺)	95,16

	ÜRÜN KODU	001 038 090101 00 00
	ÜRÜN ADI	YASEMİN DUVAR APLİK
	AMB. AD./KOLİ	2/24
	FİYAT (₺)	126,67

	ÜRÜN KODU	001 038 010201 00 00
	ÜRÜN ADI	MANOLYA DUVAR APLİK
	AMB. AD./KOLİ	2/20
	FİYAT (₺)	103,19

	ÜRÜN KODU	001 038 080101 00 00
	ÜRÜN ADI	YASEMİN OVAL ARM.
	AMB. AD./KOLİ	2/24
	FİYAT (₺)	151,65

NEMLİYER ARMATÜR ÇEŞİTLERİ



Max: 20W



ÜRÜN KODU	016 038 411100
ÜRÜN ADI	AQUA KAFESLİ APLİK BEYAZ - IP54
AMB. AD./KOLİ	1/20
FİYAT (₺)	138,94

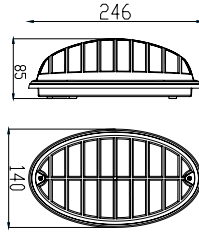

Max: 20W



ÜRÜN KODU	016 038 411111
ÜRÜN ADI	AQUA KAFESLİ APLİK SİYAH - IP54
AMB. AD./KOLİ	1/20
FİYAT (₺)	138,94



Max: 20W

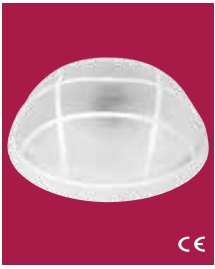

ÜRÜN KODU	016 038 411300
ÜRÜN ADI	OPAK KAFESLİ ARM. BEYAZ - IP54
AMB. AD./KOLİ	1/24
FİYAT (₺)	173,84

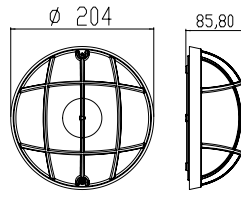

Max: 20W



ÜRÜN KODU	016 038 411311
ÜRÜN ADI	OPAK KAFESLİ ARM. SİYAH - IP54
AMB. AD./KOLİ	1/24
FİYAT (₺)	173,84



Max: 20W



ÜRÜN KODU	016 038 410600
ÜRÜN ADI	ELİPS OPAL ARM. BEYAZ - IP65
AMB. AD./KOLİ	1/10
FİYAT (₺)	327,62

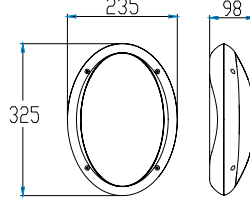

Max: 20W



ÜRÜN KODU	016 038 410611
ÜRÜN ADI	ELİPS OPAL ARM. SİYAH - IP65
AMB. AD./KOLİ	1/10
FİYAT (₺)	327,62



Max: 20W



ÜRÜN KODU	016 038 410500
ÜRÜN ADI	OPAL ARMATÜR BEYAZ - IP65
AMB. AD./KOLİ	1/10
FİYAT (₺)	319,02

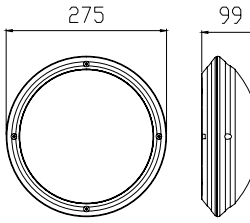

Max: 20W



ÜRÜN KODU	016 038 410511
ÜRÜN ADI	OPAL ARMATÜR SİYAH - IP65
AMB. AD./KOLİ	1/10
FİYAT (₺)	319,02



Max: 20W



ÜRÜN KODU	016 038 410800
ÜRÜN ADI	OPAK ARMATÜR BEYAZ - IP54
AMB. AD./KOLİ	1/16
FİYAT (₺)	208,17

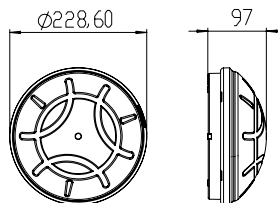

Max: 20W

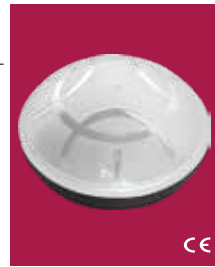

ÜRÜN KODU	016 038 410811
ÜRÜN ADI	OPAK ARMATÜR SİYAH - IP54
AMB. AD./KOLİ	1/16
FİYAT (₺)	208,17

NEMLİYER ARMATÜR ÇEŞİTLERİ



ÜRÜN KODU	016 038 700100
ÜRÜN ADI	DOLUNAY OPAK ARM. BEYAZ - IP54
AMB. AD./KOLİ	1/16
FİYAT (₺)	205,98

Max: 20W

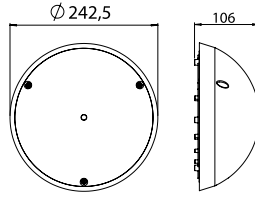

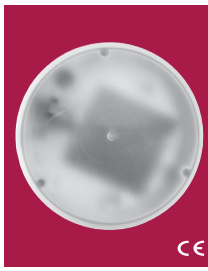

ÜRÜN KODU	016 038 700111
ÜRÜN ADI	DOLUNAY OPAK ARM. SİYAH - IP54
AMB. AD./KOLİ	1/16
FİYAT (₺)	205,98

Max: 20W

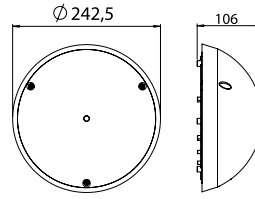

ÜRÜN KODU	016 038 700200
ÜRÜN ADI	DOLUNAY ŞEFFAF ARM. BEYAZ - IP54
AMB. AD./KOLİ	1/16
FİYAT (₺)	205,98

Max: 20W



ÜRÜN KODU	016 038 700211
ÜRÜN ADI	DOLUNAY ŞEFFAF ARM. SİYAH - IP54
AMB. AD./KOLİ	1/16
FİYAT (₺)	205,98

Max: 20W

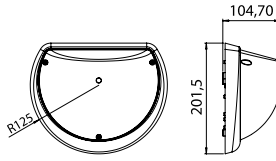

ÜRÜN KODU	016 038 700300
ÜRÜN ADI	DOLUNAY OPAK APLİK BEYAZ - IP54
AMB. AD./KOLİ	1/20
FİYAT (₺)	187,31

Max: 20W



ÜRÜN KODU	016 038 700311
ÜRÜN ADI	DOLUNAY OPAK APLİK SİYAH - IP54
AMB. AD./KOLİ	1/20
FİYAT (₺)	187,31

Max: 20W

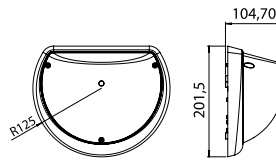

ÜRÜN KODU	016 038 700400
ÜRÜN ADI	DOLUNAY ŞEFFAF APLİK BEYAZ - IP54
AMB. AD./KOLİ	1/20
FİYAT (₺)	187,31

Max: 20W

ÜRÜN KODU	016 038 700411
ÜRÜN ADI	DOLUNAY ŞEFFAF APLİK SİYAH - IP54
AMB. AD./KOLİ	1/20
FİYAT (₺)	187,31

Max: 20W



ÜRÜN KODU	001 038 150101 00 00
ÜRÜN ADI	BEGONYA NEMLİYER TAVAN ARMATÜRÜ KLASİK - IP54
AMB. AD./KOLİ	12
FİYAT (₺)	292,09

Max: 60W



ÜRÜN KODU	001 038 130101 00 00
ÜRÜN ADI	BEGONYA NEMLİYER TAVAN ARMATÜRÜ DİKEY - IP54
AMB. AD./KOLİ	12
FİYAT (₺)	292,09

Max: 60W



ÜRÜN KODU	001 038 140101 00 00
ÜRÜN ADI	BEGONYA NEMLİYER TAVAN ARMATÜRÜ YATAY - IP54
AMB. AD./KOLİ	12
FİYAT (₺)	292,09

Max: 60W

BAHÇE ARMATÜRLERİ



Ürün Kodu	Ürün Adı	Ambalaj Adet/Koli	Fiyat (₺)
016 038 010116	FLORA BAHÇE ARMATÜRÜ - SİYAH	1/12	258,59
016 038 020116	FLORA BAHÇE ARMATÜRÜ - BEYAZ	1/12	258,59



Ürün Kodu	Ürün Adı	Ambalaj Adet/Koli	Fiyat (₺)
016 038 010117	FLORA BAHÇE ARMATÜRÜ APLİK - SİYAH	1/12	260,16
016 038 020117	FLORA BAHÇE ARMATÜRÜ APLİK - BEYAZ	1/12	260,16



Ürün Kodu	Ürün Adı	Ambalaj Adet/Koli	Fiyat (₺)
016 038 412011	FLORA BAHÇE ARMATÜRÜ TAVAN TİPİ - SİYAH	1/12	259,85
016 038 412000	FLORA BAHÇE ARMATÜRÜ TAVAN TİPİ - BEYAZ	1/12	259,85



Ürün Kodu	Ürün Adı	Ambalaj Adet/Koli	Fiyat (₺)
016 038 412111	FLORA BAHÇE ARMATÜRÜ YARIM APLİK - SİYAH	1/20	204,53
016 038 412100	FLORA BAHÇE ARMATÜRÜ YARIM APLİK - SİYAH	1/20	204,53

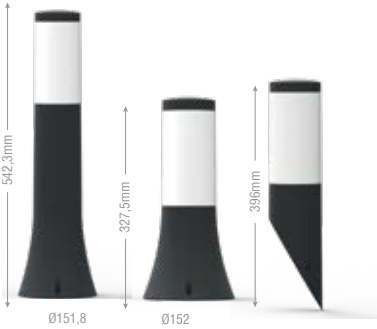

Ürün Kodu	Ürün Adı	Ölçü	Ambalaj Adet/Koli	Fiyat (₺)
016 038 010120	GARDEN UZUN YER AYDINLATMA - SİYAH	542,3mm x Ø151,8	1/8	273,86
016 038 010118	GARDEN YER AYDINLATMA - SİYAH	327,5mm x Ø152	1/12	230,76
016 038 010122	GARDEN DUVAR AYDINLATMA - SİYAH	396mm	1/20	201,99

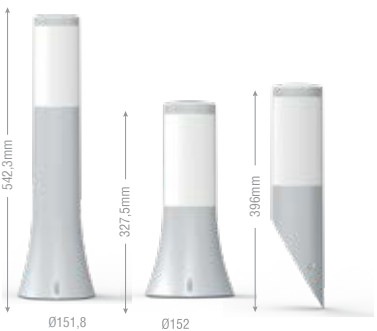

Ürün Kodu	Ürün Adı	Ölçü	Ambalaj Adet/Koli	Fiyat (₺)
016 038 010121	GARDEN UZUN YER AYDINLATMA - GRİ	542,3mm x Ø151,8	1/8	273,86
016 038 010119	GARDEN YER AYDINLATMA - GRİ	327,5mm x Ø152	1/12	230,76
016 038 010123	GARDEN DUVAR AYDINLATMA - GRİ	396mm	1/20	201,99



Ürün Kodu	Ürün Adı	Ambalaj Adet/Koli	Fiyat (₺)
016 038 010124	GARDEN APLİK - SİYAH	1/16	276,87
016 038 010125	GARDEN APLİK - GRİ	1/16	276,87

EXIT - ACİL AYDINLATMA ARMATÜRLERİ (LEDLİ) - IP20 CE









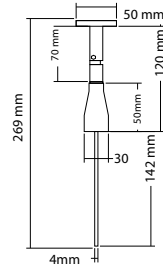
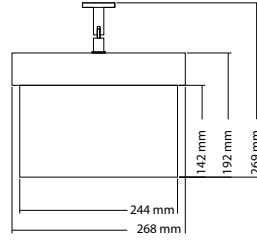



















































102 038 0008XX - CEXA

FİYAT : 410,00 ₺

*GÖVDE : ABS
 *CAM : Polistren (PS) isteğe bağlı Akrilik(PMMA) veya Policarbon(PC)
 *BASKI : Akrilik Işık geçirgen Translucent Folyo
 *ÇALIŞMA : Acil de ve Şebeke de sürekli çalışma
 *PİL : 3.6V 80mAH NiMH (NikelMethalhidrid)
 *ŞARJ SÜRESİ : 14-20 Saat
 *DEŞARJ SÜRESİ : 180 Dk
 *KORUMA SINIFI : IP20
 *LED : 4.8mm 6000K Beyaz Mantar Led
 veya 2835 6400K EDİSON OPTO SMD Led
 TÜKETİM : 2 Watt

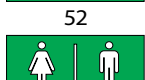
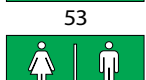
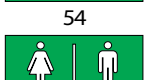
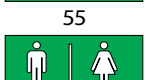
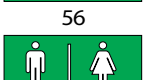
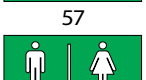

							
01	02	03	04	05	06	07	08
							
09	10	11	12	13	14		
							
15	16	17	18	19	20		
							
21	22	23	24	25	26		
							
27	28	29	30	31	32		
							
33	34	35	36				
							
37	38	39	40	41	42	43	
							
44	45	46	47	48	49	50	51
							
52	53	54	55	56	57	58	59
							
60	61	62	63	64	65		

*Sipariş Verdiğiniz Ürünün Sembol Kodunu Yazmayı Unutmayınız.

*Ürün Kodunun Son 2 hanesi olan XX Rakamları Ürünün Sembol Kodunu belirtmektedir.



PANO ve ENDÜSTRİYEL ÜRÜN GRUBU

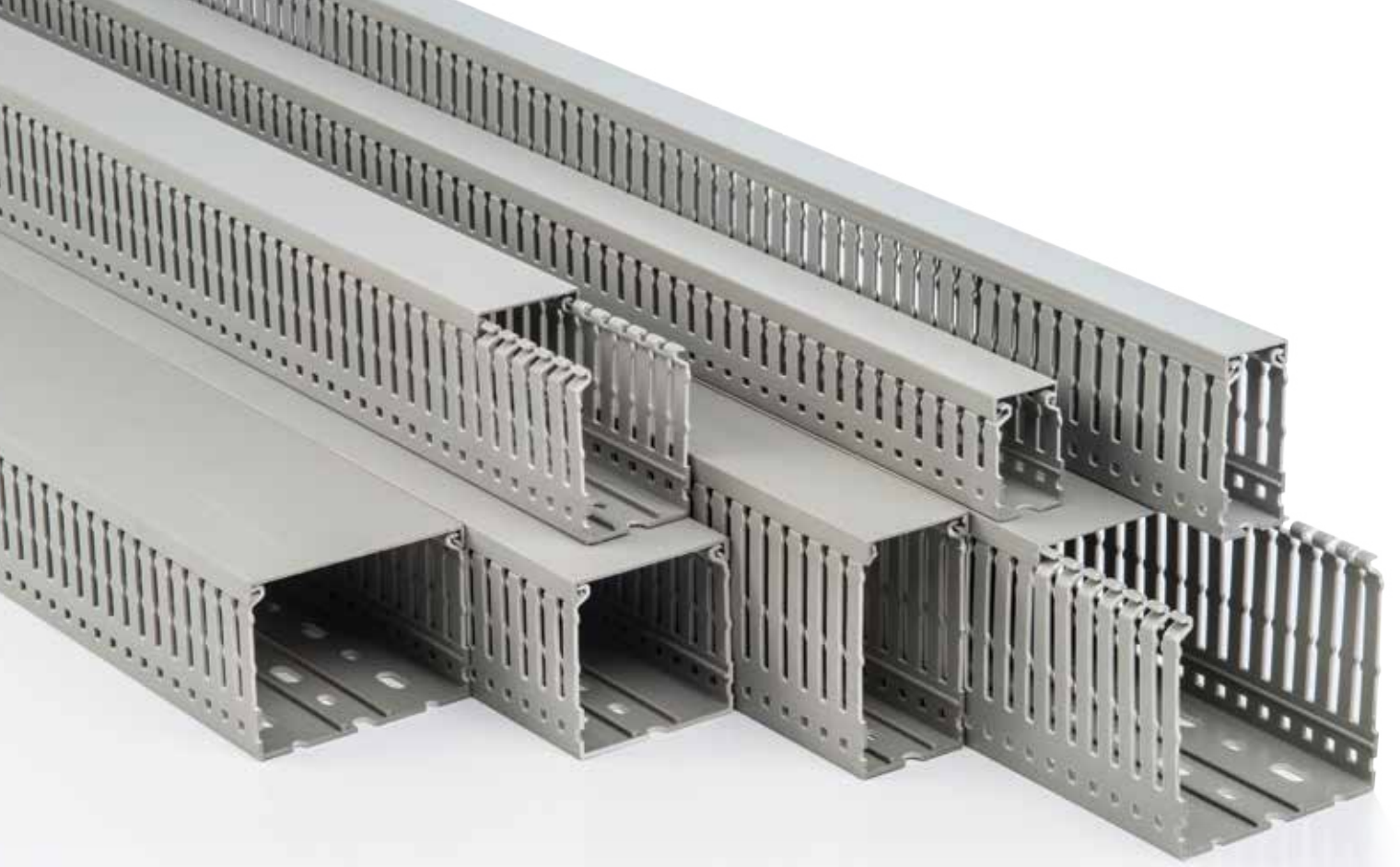

Promex

**PANO TIPI
DELİKLİ
KABLO KANALLARI**

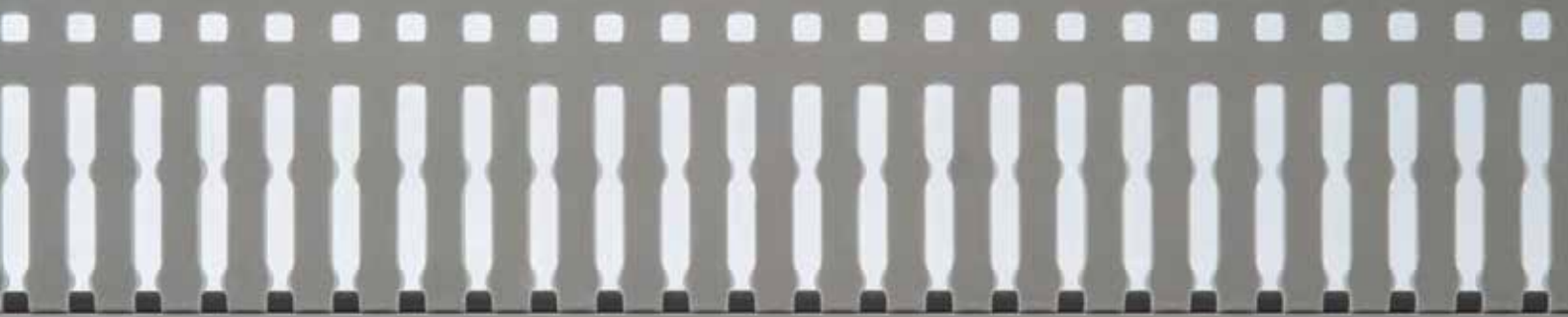



Kanal tırnakları tabanın üst noktasından, herhangi bir el aletine gereksinim duymadan 90 derecelik bükülme sonucu kolayca kırılabilir.



Özel tırnak tasarım yapısı ile kablolarınızı sıkıştırabilirsiniz. Kanal içindeki kabloların, kablo bağı ile bağlanmasına imkan veren delikleri sayesinde daha düzenli ve hızlı kablolama imkanına sahip olursunuz.



Kanal yan duvarı, kolay kırılma çizgileri sayesinde tabana sıfır olarak kırılabilir.



Özel kapak tasarımı, kanalın hangi konumda monte edildiğine bakılmaksızın kapağı kolayca monte etmemizi ve sökmemizi sağlar. Yoğun kablolamalarda bile kapağın kendinden çıkmasını engeller.

UL94-V0 alev iletmez özelliğe sahip PVC hammaddeden imal

Slot aralığı 4/6/4 + 5/8/5 mm genişliğinde

Taban montaj delikleri DIN 43659 standartına uygun

Standart kanal boyları 2mt

EN 5085-2-3 standartlarına uygun

Her türlü sevkiyat ve depolama koşullarına dayanıklı özel karton ambalaj

Standart renk RAL7030 Gri, istek üzerine diğer renkler üretilebilir

CE, RoHS sertifikalı

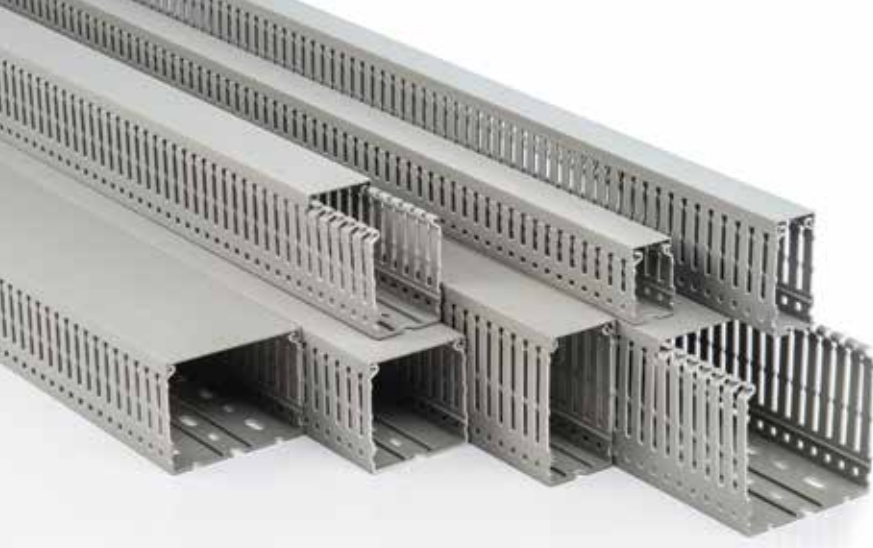

Promex

PANO TİPİ DELİKLİ KABLO KANALLARI



Ürün Kodu	Ölçü (mm)	Ürün Adı	Slot Aralığı (mm)	Ambalaj/Mt.	Fiyat (₺)
PROMEX DELİKLİ KABLO KANALI					
001 105 025030 20 17	25x30	PROMEX DELİKLİ KABLO KANALI	4/6/4 mm	2m. 120	59,17
001 105 025040 20 17	25x40	PROMEX DELİKLİ KABLO KANALI	4/6/4 mm	2m. 128	62,17
001 105 025060 20 17	25x60	PROMEX DELİKLİ KABLO KANALI	4/6/4 mm	2m. 96	80,33
001 105 025080 20 17	25x80	PROMEX DELİKLİ KABLO KANALI	4/6/4 mm	2m. 64	99,18
001 105 040040 20 17	40x40	PROMEX DELİKLİ KABLO KANALI	4/6/4 mm	2m. 70	78,12
001 105 040060 20 17	40x60	PROMEX DELİKLİ KABLO KANALI	4/6/4 mm	2m. 60	91,02
001 105 040080 20 17	40x80	PROMEX DELİKLİ KABLO KANALI	4/6/4 mm	2m. 40	119,35
001 105 040100 20 17	40x100	PROMEX DELİKLİ KABLO KANALI	5/8/5 mm	2m. 40	143,33
001 105 060040 20 17	60x40	PROMEX DELİKLİ KABLO KANALI	4/6/4 mm	2m. 50	105,6
001 105 060060 20 17	60x60	PROMEX DELİKLİ KABLO KANALI	4/6/4 mm	2m. 48	126,95
001 105 060080 20 17	60x80	PROMEX DELİKLİ KABLO KANALI	4/6/4 mm	2m. 32	155,08
001 105 060100 20 17	60x100	PROMEX DELİKLİ KABLO KANALI	5/8/5 mm	2m. 32	166,61
001 105 080060 20 17	80x60	PROMEX DELİKLİ KABLO KANALI	4/6/4 mm	2m. 25	150,72
001 105 080080 20 17	80x80	PROMEX DELİKLİ KABLO KANALI	4/6/4 mm	2m. 24	184,94
001 105 080100 20 17	80x100	PROMEX DELİKLİ KABLO KANALI	5/8/5 mm	2m. 24	273,09
001 105 100060 20 17	100x60	PROMEX DELİKLİ KABLO KANALI	4/6/4 mm	2m. 20	203,76
001 105 100080 20 17	100x80	PROMEX DELİKLİ KABLO KANALI	4/6/4 mm	2m. 20	205,61
001 105 100100 20 17	100x100	PROMEX DELİKLİ KABLO KANALI	5/8/5 mm	2m. 16	317,34
001 105 120060 20 17	120x60	PROMEX DELİKLİ KABLO KANALI	4/6/4 mm	2m. 20	208,99
001 105 120080 20 17	120x80	PROMEX DELİKLİ KABLO KANALI	4/6/4 mm	2m. 16	280,33

PROMEX FLARET SERİSİ DELİKLİ KABLO KANALI - HALOGEN FREE



001 065 025030 20 17	25x30	PROMEX H.F. DELİKLİ KABLO KANALI	4/6/4 mm	2m. 120	218,95
001 065 025040 20 17	25x40	PROMEX H.F. DELİKLİ KABLO KANALI	4/6/4 mm	2m. 128	242,47
001 065 025060 20 17	25x60	PROMEX H.F. DELİKLİ KABLO KANALI	4/6/4 mm	2m. 96	297,21
001 065 025080 20 17	25x80	PROMEX H.F. DELİKLİ KABLO KANALI	4/6/4 mm	2m. 64	366,96
001 065 040040 20 17	40x40	PROMEX H.F. DELİKLİ KABLO KANALI	4/6/4 mm	2m. 70	304,67
001 065 040060 20 17	40x60	PROMEX H.F. DELİKLİ KABLO KANALI	4/6/4 mm	2m. 60	373,18
001 065 040080 20 17	40x80	PROMEX H.F. DELİKLİ KABLO KANALI	4/6/4 mm	2m. 40	441,6
001 065 040100 20 17	40x100	PROMEX H.F. DELİKLİ KABLO KANALI	5/8/5 mm	2m. 40	530,33
001 065 060040 20 17	60x40	PROMEX H.F. DELİKLİ KABLO KANALI	4/6/4 mm	2m. 50	443,51
001 065 060060 20 17	60x60	PROMEX H.F. DELİKLİ KABLO KANALI	4/6/4 mm	2m. 48	482,39
001 065 060080 20 17	60x80	PROMEX H.F. DELİKLİ KABLO KANALI	4/6/4 mm	2m. 32	573,79
001 065 060100 20 17	60x100	PROMEX H.F. DELİKLİ KABLO KANALI	5/8/5 mm	2m. 32	616,46
001 065 080060 20 17	80x60	PROMEX H.F. DELİKLİ KABLO KANALI	4/6/4 mm	2m. 25	587,82
001 065 080080 20 17	80x80	PROMEX H.F. DELİKLİ KABLO KANALI	4/6/4 mm	2m. 24	684,3
001 065 080100 20 17	80x100	PROMEX H.F. DELİKLİ KABLO KANALI	5/8/5 mm	2m. 24	764,65
001 065 100060 20 17	100x60	PROMEX H.F. DELİKLİ KABLO KANALI	4/6/4 mm	2m. 20	753,92
001 065 100080 20 17	100x80	PROMEX H.F. DELİKLİ KABLO KANALI	4/6/4 mm	2m. 20	781,34
001 065 100100 20 17	100x100	PROMEX H.F. DELİKLİ KABLO KANALI	5/8/5 mm	2m. 16	952,02
001 065 120060 20 17	120x60	PROMEX H.F. DELİKLİ KABLO KANALI	4/6/4 mm	2m. 20	815,06
001 065 120080 20 17	120x80	PROMEX H.F. DELİKLİ KABLO KANALI	4/6/4 mm	2m. 16	981,14

PROMEX KABLO KANALI KAPAKLARI

001 016 100025 20 17	25'LİK	PROMEX KAPAK		50	16,24
001 016 100040 20 17	40'LİK	PROMEX KAPAK		50	20,03
001 016 100060 20 17	60'LİK	PROMEX KAPAK		50	30,91
001 016 100080 20 17	80'LİK	PROMEX KAPAK		50	38,43
001 016 100100 20 17	100'LÜK	PROMEX KAPAK		50	44,38
001 016 100120 20 17	120'LİK	PROMEX KAPAK		50	55,14

XX : 10 1mt. delikli kablo kanalı için.
XX : 20 2mt. delikli kablo kanalı için.

Ürün Kodu	Ölçü (mm)	Ürün Adı	Ambalaj Koli - 1 mt	Ambalaj Koli - 2 mt	Fiyat (₺)
-----------	-----------	----------	---------------------	---------------------	-----------

PANO İÇİN MEKS DELİKLİ KABLO KANALLAR (GRİ)

001 005 025025 XX 17	25x25	MEKS DELİKLİ KABLO KANALI(GRİ)	1mt. 64	2mt. 120	34,35
001 005 025040 XX 17	25x40	MEKS DELİKLİ KABLO KANALI(GRİ)	1mt. 40	2mt. 80	44,02
001 005 025060 XX 17	25x60	MEKS DELİKLİ KABLO KANALI(GRİ)	1mt. 36	2mt. 80	75,6
001 005 040040 XX 17	40x40	MEKS DELİKLİ KABLO KANALI(GRİ)	1mt. 25	2mt. 50	56,58
001 005 040060 XX 17	40x60	MEKS DELİKLİ KABLO KANALI(GRİ)	1mt. 24	2mt. 48	75,5
001 005 060040 XX 17	60x40	MEKS DELİKLİ KABLO KANALI(GRİ)	1mt. 24	2mt. 48	77,26
001 005 060060 XX 17	60x60	MEKS DELİKLİ KABLO KANALI(GRİ)	1mt. 16	2mt. 32	97,2
001 005 060080 XX 17	60x80	MEKS DELİKLİ KABLO KANALI(GRİ)	1mt. 12	2mt. 24	119,71
001 005 060100 XX 17	60x100	MEKS DELİKLİ KABLO KANALI(GRİ)	1mt. 8	2mt. 16	133,13
001 005 040080 XX 17	40x80	MEKS DELİKLİ KABLO KANALI(GRİ)	1mt. 18	2mt. 36	132,11
001 005 080060 XX 17	80x60	MEKS DELİKLİ KABLO KANALI(GRİ)	1mt. 12	2mt. 24	138,95
001 005 100060 XX 17	100x60	MEKS DELİKLİ KABLO KANALI(GRİ)	1mt. 8	2mt. 16	170,19
001 005 100100 XX 17	100x100	MEKS DELİKLİ KABLO KANALI(GRİ)	1mt. 4	2mt. 8	225

PANO İÇİN MEKS DELİKLİ KABLO KANALLAR (MAVİ)

001 005 025025 XX 13	25x25	MEKS DELİKLİ KABLO KANALI(MAVİ)	1mt. 64	2mt. 120	35,85
001 005 025040 XX 13	25x40	MEKS DELİKLİ KABLO KANALI(MAVİ)	1mt. 40	2mt. 80	45,97
001 005 025060 XX 13	25x60	MEKS DELİKLİ KABLO KANALI(MAVİ)	1mt. 36	2mt. 80	78,94
001 005 040040 XX 13	40x40	MEKS DELİKLİ KABLO KANALI(MAVİ)	1mt. 25	2mt. 50	59,09
001 005 040060 XX 13	40x60	MEKS DELİKLİ KABLO KANALI(MAVİ)	1mt. 24	2mt. 48	79,75
001 005 060040 XX 13	60x40	MEKS DELİKLİ KABLO KANALI(MAVİ)	1mt. 24	2mt. 48	80,98
001 005 060060 XX 13	60x60	MEKS DELİKLİ KABLO KANALI(MAVİ)	1mt. 16	2mt. 32	104,02
001 005 060080 XX 13	60x80	MEKS DELİKLİ KABLO KANALI(MAVİ)	1mt. 12	2mt. 24	129,95
001 005 060100 XX 13	60x100	MEKS DELİKLİ KABLO KANALI(MAVİ)	1mt. 8	2mt. 16	140,36
001 005 040080 XX 13	40x80	MEKS DELİKLİ KABLO KANALI(MAVİ)	1mt. 18	2mt. 36	139,26
001 005 080060 XX 13	80x60	MEKS DELİKLİ KABLO KANALI(MAVİ)	1mt. 12	2mt. 24	150,47
001 005 100060 XX 13	100x60	MEKS DELİKLİ KABLO KANALI(MAVİ)	1mt. 8	2mt. 16	205,14
001 005 100100 XX 13	100x100	MEKS DELİKLİ KABLO KANALI(MAVİ)	1mt. 4	2mt. 8	272,2

YAPIŞKAN BANTLI MEKS DELİKLİ KABLO KANALLAR (GRİ)

001 008 025025 XX 17	25x25	MEKS DELİKLİ KABLO KANALI(YPŞK. BANTLI)(GRİ)	1mt. 64	2mt. 120	38,25
001 008 025040 XX 17	25x40	MEKS DELİKLİ KABLO KANALI(YPŞK. BANTLI)(GRİ)	1mt. 40	2mt. 80	46,53
001 008 025060 XX 17	25x60	MEKS DELİKLİ KABLO KANALI(YPŞK. BANTLI)(GRİ)	1mt. 36	2mt. 80	79,22
001 008 040040 XX 17	40x40	MEKS DELİKLİ KABLO KANALI(YPŞK. BANTLI)(GRİ)	1mt. 25	2mt. 50	59,19
001 008 040060 XX 17	40x60	MEKS DELİKLİ KABLO KANALI(YPŞK. BANTLI)(GRİ)	1mt. 24	2mt. 48	79,9
001 008 060040 XX 17	60x40	MEKS DELİKLİ KABLO KANALI(YPŞK. BANTLI)(GRİ)	1mt. 24	2mt. 48	82,58
001 008 060060 XX 17	60x60	MEKS DELİKLİ KABLO KANALI(YPŞK. BANTLI)(GRİ)	1mt. 16	2mt. 32	105,09
001 008 060080 XX 17	60x80	MEKS DELİKLİ KABLO KANALI(YPŞK. BANTLI)(GRİ)	1mt. 12	2mt. 24	131,66
001 008 060100 XX 17	60x100	MEKS DELİKLİ KABLO KANALI(YPŞK. BANTLI)(GRİ)	1mt. 8	2mt. 16	142,03
001 008 040080 XX 17	40x80	MEKS DELİKLİ KABLO KANALI(YPŞK. BANTLI)(GRİ)	1mt. 18	2mt. 36	141,54
001 008 080060 XX 17	80x60	MEKS DELİKLİ KABLO KANALI(YPŞK. BANTLI)(GRİ)	1mt. 12	2mt. 24	151,68
001 008 100060 XX 17	100x60	MEKS DELİKLİ KABLO KANALI(YPŞK. BANTLI)(GRİ)	1mt. 8	2mt. 16	179,48
001 008 100100 XX 17	100x100	MEKS DELİKLİ KABLO KANALI(YPŞK. BANTLI)(GRİ)	1mt. 4	2mt. 8	232,6

YAPIŞKAN BANTLI MEKS DELİKLİ KABLO KANALLAR (MAVİ)

001 008 025025 XX 13	25x25	MEKS DELİKLİ KABLO KANALI(YPŞK. BANTLI)(MAVİ)	1mt. 64	2mt. 120	38,44
001 008 025040 XX 13	25x40	MEKS DELİKLİ KABLO KANALI(YPŞK. BANTLI)(MAVİ)	1mt. 40	2mt. 80	48,57
001 008 025060 XX 13	25x60	MEKS DELİKLİ KABLO KANALI(YPŞK. BANTLI)(MAVİ)	1mt. 36	2mt. 80	81,54
001 008 040040 XX 13	40x40	MEKS DELİKLİ KABLO KANALI(YPŞK. BANTLI)(MAVİ)	1mt. 25	2mt. 50	65,27
001 008 040060 XX 13	40x60	MEKS DELİKLİ KABLO KANALI(YPŞK. BANTLI)(MAVİ)	1mt. 24	2mt. 48	81,07
001 008 060040 XX 13	60x40	MEKS DELİKLİ KABLO KANALI(YPŞK. BANTLI)(MAVİ)	1mt. 24	2mt. 48	88,97
001 008 060060 XX 13	60x60	MEKS DELİKLİ KABLO KANALI(YPŞK. BANTLI)(MAVİ)	1mt. 16	2mt. 32	117,34
001 008 060080 XX 13	60x80	MEKS DELİKLİ KABLO KANALI(YPŞK. BANTLI)(MAVİ)	1mt. 12	2mt. 24	135,23
001 008 060100 XX 13	60x100	MEKS DELİKLİ KABLO KANALI(YPŞK. BANTLI)(MAVİ)	1mt. 8	2mt. 16	202,16
001 008 040080 XX 13	40x80	MEKS DELİKLİ KABLO KANALI(YPŞK. BANTLI)(MAVİ)	1mt. 18	2mt. 36	142,13
001 008 080060 XX 13	80x60	MEKS DELİKLİ KABLO KANALI(YPŞK. BANTLI)(MAVİ)	1mt. 12	2mt. 24	159,43
001 008 100060 XX 13	100x60	MEKS DELİKLİ KABLO KANALI(YPŞK. BANTLI)(MAVİ)	1mt. 8	2mt. 16	208,06
001 008 100100 XX 13	100x100	MEKS DELİKLİ KABLO KANALI(YPŞK. BANTLI)(MAVİ)	1mt. 4	2mt. 8	278

Ürün Kodu	Ölçü (mm)	Ürün Adı	Ambalaj Kutu /Adet	Fiyat (₺)
-----------	-----------	----------	--------------------	-----------

KABLO TUTUCUCU APARATI

001 050 010001 00 00	25x40	KABLO TUTUCUCU APARATI	50	20,36
001 050 010002 00 00	40x40	KABLO TUTUCUCU APARATI	50	21,43
001 050 010003 00 00	60x40	KABLO TUTUCUCU APARATI	50	21,79

KABLO TUTUCUCU YAN APARATI

001 050 020001 00 00	40X40/60	KABLO TUTUCUCU YAN APARATI	100	6,44
001 050 020002 00 00	60X40/60	KABLO TUTUCUCU YAN APARATI	100	6,61
001 050 020004 00 00	100X60	KABLO TUTUCUCU YAN APARATI	100	11,73

KANAL KESME MAKASI

999 999 777139		PDC110 KANAL KESME MAKASI 60MM	1	540,18 €
----------------	--	--------------------------------	---	----------

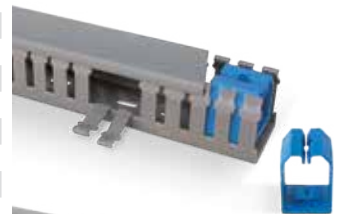
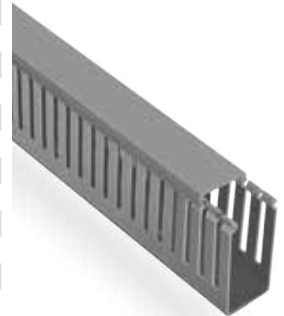
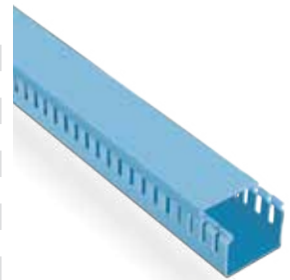
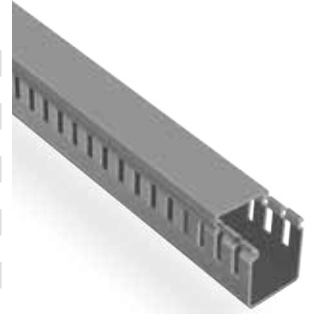

KANAL KESME MAKASI





OPAK KAPAKLI ABS PANOLAR

Ürün Kodu	Ölçü (mm)	Ürün Adı	Ağırlık (kg)	Adet	Fiyat (₺)
001 046 203013 00 17	20x30x13	PLASTİK OPAK KAPAKLI PANO	1,70	1	550,36
001 046 253515 00 17	25x35x15	PLASTİK OPAK KAPAKLI PANO	2,20	1	738,5
001 046 304017 00 17	30x40x17	PLASTİK OPAK KAPAKLI PANO	3,00	1	904,47
001 046 304022 00 17	30x40x22	PLASTİK OPAK KAPAKLI PANO	3,40	1	1.063,44
001 046 355019 00 17	35x50x19	PLASTİK OPAK KAPAKLI PANO	4,30	1	1.286,76
001 046 405018 00 17	40x50x18	PLASTİK OPAK KAPAKLI PANO	4,30	1	1.339,18
001 046 405024 00 17	40x50x24	PLASTİK OPAK KAPAKLI PANO	5,60	1	1.621,13
001 046 406020 00 17	40x60x20	PLASTİK OPAK KAPAKLI PANO	6,00	1	1.604,41
001 046 507025 00 17	50x70x25	PLASTİK OPAK KAPAKLI PANO	10,10	1	2.541,81
001 046 608026 00 17	60x80x26	PLASTİK OPAK KAPAKLI PANO	13,50	1	4.387,23

ŞEFFAF KAPAKLI ABS PANOLAR

Ürün Kodu	Ölçü (mm)	Ürün Adı	Ağırlık (kg)	Adet	Fiyat (₺)
001 046 203013 00 44	20x30x13	PLASTİK ŞEFFAF KAPAKLI PANO	1,70	1	576,68
001 046 253515 00 44	25x35x15	PLASTİK ŞEFFAF KAPAKLI PANO	2,20	1	778,01
001 046 304017 00 44	30x40x17	PLASTİK ŞEFFAF KAPAKLI PANO	3,00	1	946,81
001 046 304022 00 44	30x40x22	PLASTİK ŞEFFAF KAPAKLI PANO	3,40	1	1.109,48
001 046 355019 00 44	35x50x19	PLASTİK ŞEFFAF KAPAKLI PANO	4,30	1	1.412,12
001 046 405018 00 44	40x50x18	PLASTİK ŞEFFAF KAPAKLI PANO	4,30	1	1.552,48
001 046 405024 00 44	40x50x24	PLASTİK ŞEFFAF KAPAKLI PANO	5,60	1	1847,3
001 046 406020 00 44	40x60x20	PLASTİK ŞEFFAF KAPAKLI PANO	6,00	1	1.900,31
001 046 507025 00 44	50x70x25	PLASTİK ŞEFFAF KAPAKLI PANO	10,10	1	2.921,79
001 046 608026 00 44	60x80x26	PLASTİK ŞEFFAF KAPAKLI PANO	13,50	1	4.902,95



IP65 CE

OPAK KAPAKLI ABS OTOMAT PANOLAR

Ürün Kodu	Ölçü (mm)	Ürün Adı	Ağırlık (kg)	Adet	Fiyat (₺)
001 046 253515 01 17	25x35x15	18 OTOMATLI (9x2)	2,50	1	1.366,37
001 046 304017 01 17	30x40x17	24 OTOMATLI (12x2)	3,40	1	1.620,78
001 046 355019 01 17	35x50x19	45 OTOMATLI (15x3)	4,50	1	2.081,27
001 046 406020 01 17	40x60x20	60 OTOMATLI (15x4)	6,00	1	2.495,35



IP65 CE

ŞEFFAF KAPAKLI ABS OTOMAT PANOLAR

Ürün Kodu	Ölçü (mm)	Ürün Adı	Ağırlık (kg)	Adet	Fiyat (₺)
001 046 253515 01 44	25x35x15	18 OTOMATLI (9x2)	2,50	1	1.403,99
001 046 304017 01 44	30x40x17	24 OTOMATLI (12x2)	3,40	1	1.663,8
001 046 355019 01 44	35x50x19	45 OTOMATLI (15x3)	4,50	1	2.147,22
001 046 406020 01 44	40x60x20	60 OTOMATLI (15x4)	6,00	1	2.712,07



PANO PRİZLERİ



ÜRÜN KODU	010 104 000157
ÜRÜN ADI	MRP-16 1x16 RAY TİPİ PANO PRİZİ
AMB. AD./KOLİ	10
FİYAT (₺)	171,68



ÜRÜN KODU	010 104 000158
ÜRÜN ADI	MRP-LED 10x16 RAY TİPİ PANO PRİZİ - LEDLİ
AMB. AD./KOLİ	10
FİYAT (₺)	219,57



ÜRÜN KODU	010 104 000159
ÜRÜN ADI	MRP-UPS 1X16 RAY TİPİ PANO PRİZİ - UPS
AMB. AD./KOLİ	10
FİYAT (₺)	219,57



GALVANİZ TABAN SAÇLARI

Ürün Kodu	Ölçü (mm)	Ürün Adı	Adet	Fiyat (₺)
000 702 203013 00 00	20x30x13	GALVANİZ TABAN SAÇI 1mm	1	105,31
000 702 253515 00 00	25x35x15	GALVANİZ TABAN SAÇI 1mm	1	115,95
000 702 304017 00 00	30x40x17	GALVANİZ TABAN SAÇI 1mm	1	148,79
000 702 304022 00 00	30x40x22	GALVANİZ TABAN SAÇI 1mm	1	152,74
000 702 355019 00 00	35x50x19	GALVANİZ TABAN SAÇI 1mm	1	214,23
000 702 405018 00 00	40x50x17,5	GALVANİZ TABAN SAÇI 1mm	1	251,03
000 702 405024 00 00	40x50x24	GALVANİZ TABAN SAÇI 1mm	1	245,23
000 702 406020 00 00	40x60x20	GALVANİZ TABAN SAÇI 1mm	1	287,6
000 702 507025 00 00	50x70x25	GALVANİZ TABAN SAÇI 1mm	1	427,79



MODÜLER KİTLER ve SEPERATÖRLER

Ürün Kodu	Ölçü (mm)	Ürün Adı	Adet	Fiyat (₺)
000 700 253515 01 17	25X35X15	18 OTOMATLI (9X2)	1	766,62
000 700 304017 01 17	30X40X17	24 OTOMATLI (12X2)	1	867,93
000 700 355019 01 17	35X50X19	45 OTOMATLI (15X3)	1	1193,35
000 700 406020 01 17	40X60X20	60 OTOMATLI (15X4)	1	1254,5
000 700 253515 00 17	25X35X15	PLASTİK PERDE	1	118,38
000 700 304017 00 17	30X40X17	PLASTİK PERDE	1	153,55
000 700 355019 00 17	35X50X19	PLASTİK PERDE	1	251,27
000 700 406020 00 17	40X60X20	PLASTİK PERDE	1	278,08



PANO AKSESUARLARI

Ürün Kodu	Ürün Adı	Adet	Fiyat (₺)
000 700 000700 00 17	PANO KİLİT GÖBEK TAKIMI (SET)	1	39,62
000 700 000701 00 17	PANO AKSESUARI (4'LÜ SET)	1	36,49
000 700 000702 00 17	PLASTİK PANO ÜÇGEN ANAHTAR	1	22,83
000 700 000703 00 17	PANO SEPERATÖRÜ TUTTURMA VİDASI	1	18,57
000 700 000704 00 17	PLASTİK KİLİTLENEBİLİR PANO (METAL) KİLİDİ	1	156,83

DİJİTAL TERMOSTAT ve HİGROSTAT

PDT 50-150 SICAKLIK KONTROL CİHAZI

ÜRÜN KODU	048 095 000304
ÖLÇÜLER	36x90x65mm RAYA MONTAJ
GÖSTERGE	3 HANE 7 SEGMENT
SENSÖR	PTC
ÖLÇME SKALASI	-50...+150 °C
DUYARLILIK	± C
DOĞRULUK	±%1 (Tam Skalanın)
KONTROL DURUMU	ON-OFF
OUT ÇIKIŞI	RÖLE, 250V AC, 2A, REZİSTİF YÜK
ALARM ÇIKIŞI	RÖLE, 250V AC, 2A, REZİSTİF YÜK
HEAT SET AYARI	LoL...UPL C (Hst)
ALARM SET AYARI	AtP=Abs,-Ab; LoL...C(Ast) Atp=rEL, -rL; (HSt+rAL), (HSt-20)...(Hst+20) C
HEAT HİSTERESİZ	1...20 C (Hhs)
ALARM HİSTERESİZ	1...20 C (Hhs)
OFFSET	-20...+20 °C
ISITMA / SOĞUTMA	H-C; Ht(Isıtma), CL (Soğutma); SEÇMELİ
BESLEME VOLTAJ	100...240V AC, 50/60 Hz
GÜÇ TÜKETİMİ	<6VA
ÇALIŞMA SICAKLIĞI	-20 °C...55 °C
İŞLETME İRTİFASI	<2000m
ADET	1
FİYAT	194,49 \$

* NOT: PTC SENSÖR CİHAZ DAHİLİNDEDİR.



HT-310 SICAKLIK VE NEM KONTROL CİHAZI

ÜRÜN KODU	048 095 000305
ÖLÇÜLER	35x77mm
GÖSTERGE	3 HANE 7 SEGMENT
SENSÖR	DİJİTAL SICAKLIK NEM SENSÖRÜ
ÖLÇME SKALASI	-19,9...+80,0C, 5...95%RH
DUYARLILIK	±0,1C, ±1%RH
DOĞRULUK	±%1 (C), ±%3 (%RH) (Tam Skalanın)
KONTROL DURUMU	ON-OFF
C OUT ÇIKIŞI	RÖLE (NA+NK), 250V AC, 2A, REZİSTİF YÜK
%RH OUT ÇIKIŞI	RÖLE (NA), 250V AC, 2A, REZİSTİF YÜK
ISITMA / SOĞUTMA	Ht(Isıtma), CL (Soğutma); SEÇMELİ
BESLEME VOLTAJ	100...220V AC, 50/60 Hz
GÜÇ TÜKETİMİ	<6VA
ÇALIŞMA SICAKLIĞI	0°C...55°C
İŞLETME İRTİFASI	<2000m
ADET	1
FİYAT	222,96 \$

* NOT: SICAKLIK VE NEM SENSÖRÜ CİHAZ DAHİLİNDEDİR.



ENERJİ TASARRUFU SAĞLAR

Doğru sıcaklık değerini korumak için ısıtma veya soğutma cihazlarını açıp kapatarak veya bir ısı transfer sıvısının akışını gerektiği gibi düzenleyerek kontrol yapar.



TERMOSTAT ve HİGROSTAT



ISITMA TERMOSTAT - NK

ÜRÜN KODU	048 095 000300
AYAR SAHASI	0-60°C
KONTAK TİPİ	NK
KORUMA SINIFI	IP20
AĞIRLIK	45 GR
ADET / KOLİ	135
FİYAT	11,39 \$



SOĞUTMA TERMOSTAT - NA

ÜRÜN KODU	048 095 000301
AYAR SAHASI	0-60°C
KONTAK TİPİ	NA
KORUMA SINIFI	IP20
AĞIRLIK	45 GR
ADET / KOLİ	135
FİYAT	11,39 \$



DUAL TERMOSTAT - NK+NA

ÜRÜN KODU	048 095 000302
AYAR SAHASI	0-60°C / 0-60°C
KONTAK TİPİ	NK+NA
KORUMA SINIFI	IP20
AĞIRLIK	80 GR
ADET / KOLİ	60
FİYAT	23,27 \$



MEKANİK HİGROSTAT - 1CO

ÜRÜN KODU	048 095 000303
AYAR SAHASI	%10-90RH
KONTAK TİPİ	1CO
KORUMA SINIFI	IP20
AĞIRLIK	180 GR
ADET / KOLİ	30
FİYAT	90,13 \$

TERMOSTAT ve HİGROSTAT



SOĞUTUCU TERMOSTAT

ÜRÜN KODU	048 095 101141
AYAR SAHASI	0-60°C
KONTAK TİPİ	NO
KORUMA SINIFI	IP20
AĞIRLIK	45 GR
ADET / KOLİ	1
FİYAT	6,55 \$



ISITICI TERMOSTAT

ÜRÜN KODU	048 095 101140
AYAR SAHASI	0-60°C
KONTAK TİPİ	NC
KORUMA SINIFI	IP20
AĞIRLIK	45 GR
ADET / KOLİ	1
FİYAT	6,55 \$



MULTİ TERMOSTAT

ÜRÜN KODU	048 095 101142
AYAR SAHASI	0-60°C / 0-60°C
KONTAK TİPİ	NC+NO
KORUMA SINIFI	IP20
AĞIRLIK	80 GR
ADET / KOLİ	1
FİYAT	22,59 \$



HİGROSTAT

ÜRÜN KODU	048 095 101143
AYAR SAHASI	%40-90RH
KONTAK TİPİ	1CO
KORUMA SINIFI	IP20
AĞIRLIK	180 GR
ADET / KOLİ	1
FİYAT	67,77 \$



ODA TERMOSTAT

ÜRÜN KODU	048 095 101144
AYAR SAHASI	%10-90RH
KONTAK TİPİ	1CO
KORUMA SINIFI	IP20
AĞIRLIK	180 GR
ADET / KOLİ	1
FİYAT	72,29 \$



IP54



Poliüretan Conta



Radyal Fan

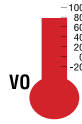

VO Alev İletmez ABS

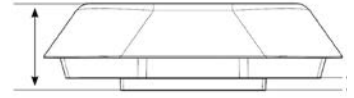
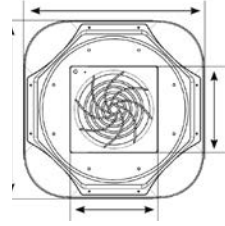

TEPE FANLARI

Ürün Kodu	Fan Tipi	Besleme	Güç (W)	Nominal Akım	Gürültü Seviyesi	Kapasite	Adet	Fiyat
048 095 000100	Ø172x163x51 AKSİYEL	220V AC 50/60 Hz	25/32W	0,11/0,15A	57 dB	400 m³/h	1	128,08 \$
048 095 000101	Ø190x68 RADYAL	220V AC 50/60 Hz	58/75W	0,26/0,34A	62 dB	560 m³/h	1	192,14 \$
048 095 000102	Ø220X71 RADYAL	220V AC 50/60 Hz	85/90W	0,38/0,44A	73 dB	970 m³/h	1	224,4 \$



Vidasız hızlı ve kolay montaj !



IP54



Poliüretan Conta



Radyal Fan

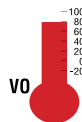

VO Alev İletmez ABS



Hızlı ve Kolay
Montaj

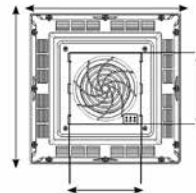

Ürün Kodu	Fan Tipi	Besleme	Güç (W)	Nominal Akım	Gürültü Seviyesi	Kapasite	Adet	Fiyat
048 095 000200	Ø172x163x51 AKSİYEL	220V AC 50/60 Hz	25/32W	0,11/0,15A	57 dB	400 m³/h	1	128,08 \$
048 095 000201	Ø190x68 RADYAL	220V AC 50/60 Hz	58/75W	0,26/0,34A	62 dB	560 m³/h	1	192,14 \$
048 095 000202	Ø220X71 RADYAL	220V AC 50/60 Hz	85/90W	0,38/0,44A	73 dB	970 m³/h	1	224,4 \$



IP54



Poliüretan Conta



Radyal Fan



VO Alev İletmez ABS

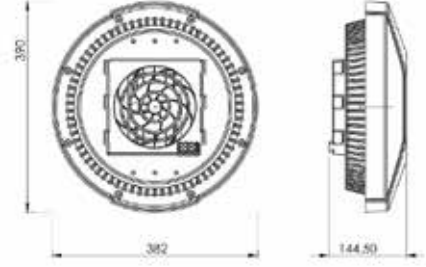

TEPE FANLARI

Ürün Kodu	Fan Tipi	Besleme	Güç (W)	Nominal Akım	Gürültü Seviyesi	Kapasite	Adet	Fiyat
048 095 100100	MTF300	230V AC 50/60 Hz	35W	0,15A	51 dB	300 m ³ /h	1	135,54 \$
048 095 100101	MTF 600	230V AC 50/60 Hz	65W	0,30A	60 dB	634 m ³ /h	1	162,64 \$
048 095 100102	MTF 900	230V AC 50/60 Hz	90W	0,48A	60 dB	900 m ³ /h	1	180,71 \$
048 095 100103	MTF 1200	230V AC 50/60 Hz	90W	0,48A	90 dB	1200 m ³ /h	1	203,3 \$

KOLAY MONTAJ FİLTRELER

ÜRÜN KODU	048 095 000400
ÖLÇÜ	120x120x20,5 mm
KESİM ÖLÇÜSÜ	92x92 mm
KORUMA SINIFI	IP54
ADET / KOLİ	200
FİYAT	6,64 \$



ÜRÜN KODU	048 095 000401
ÖLÇÜ	160x160x31 mm
KESİM ÖLÇÜSÜ	125x125 mm
KORUMA SINIFI	IP54
ADET / KOLİ	100
FİYAT	8,09 \$



ÜRÜN KODU	048 095 000402
ÖLÇÜ	210x210x31 mm
KESİM ÖLÇÜSÜ	177x177 mm
KORUMA SINIFI	IP54
ADET / KOLİ	100
FİYAT	12,83 \$



ÜRÜN KODU	048 095 000403
ÖLÇÜ	260x260x31 mm
KESİM ÖLÇÜSÜ	223x223 mm
KORUMA SINIFI	IP54
ADET / KOLİ	50
FİYAT	18,52 \$



ÜRÜN KODU	048 095 000404
ÖLÇÜ	325x325x31 mm
KESİM ÖLÇÜSÜ	291x291 mm
KORUMA SINIFI	IP54
ADET / KOLİ	50
FİYAT	32,01 \$



PROJE CEPLERİ

ÜRÜN KODU	048 095 000902
ÜRÜN ADI	PROJE CEBİ A4
ADET / KOLİ	10
FİYAT	4,74 \$

ÜRÜN KODU	048 095 000903
ÜRÜN ADI	PROJE CEBİ A5
ADET / KOLİ	10
FİYAT	3,8 \$



FİLTRELİ FANLAR



ÜRÜN KODU	048 095 000500
ÖLÇÜ (mm)	120x120x58,5
KESİM ÖLÇÜSÜ (mm)	92x92
FAN TİPİ	80x80x38
BESLEME (V AC)	230V-50/60Hz
GÜÇ (W)	14 (13)
HIZ (rpm)	2800
FİLTRELİ (m ³ /h)	30
FİLTRESİZ (m ³ /h)	41
NOMİNAL AKIM	0,08 / 0,07
GÜRÜLTÜ SEVİYESİ (db)	28 (31)
AD. / FİYAT	38,45 \$



ÜRÜN KODU	048 095 000501
ÖLÇÜ (mm)	160x160x69
KESİM ÖLÇÜSÜ (mm)	125x125
FAN TİPİ	120x120x38
BESLEME (V AC)	230V-50/60Hz
GÜÇ (W)	26 (23)
HIZ (rpm)	2700
FİLTRELİ (m ³ /h)	100
FİLTRESİZ (m ³ /h)	140
NOMİNAL AKIM	0,14 / 0,13
GÜRÜLTÜ SEVİYESİ (db)	42 (46)
AD. / FİYAT	45,09 \$



ÜRÜN KODU	048 095 000502
ÖLÇÜ (mm)	120x120x58,5
KESİM ÖLÇÜSÜ (mm)	92x92
FAN TİPİ	80x80x38
BESLEME (V AC)	230V-50/60Hz
GÜÇ (W)	14 (13)
HIZ (rpm)	2800
FİLTRELİ (m ³ /h)	30
FİLTRESİZ (m ³ /h)	41
NOMİNAL AKIM	0,8 / 0,7
GÜRÜLTÜ SEVİYESİ (db)	28 (31)
AD. / FİYAT	45,09 \$



ÜRÜN KODU	048 095 000600
ÖLÇÜ (mm)	160x160x69
KESİM ÖLÇÜSÜ (mm)	125x125
FAN TİPİ	120x120x38
BESLEME (V AC)	230V-50/60Hz
GÜÇ (W)	26 (23)
HIZ (rpm)	2700
FİLTRELİ (m ³ /h)	100
FİLTRESİZ (m ³ /h)	140
NOMİNAL AKIM	0,14 / 0,13
GÜRÜLTÜ SEVİYESİ (db)	42 (46)
AD. / FİYAT	51,23 \$



ÜRÜN KODU	048 095 000601
ÖLÇÜ (mm)	210x210x98
KESİM ÖLÇÜSÜ (mm)	177x177
FAN TİPİ	120x120x38
BESLEME (V AC)	230V-50/60Hz
GÜÇ (W)	26 (23)
HIZ (rpm)	2700
FİLTRELİ (m ³ /h)	125
FİLTRESİZ (m ³ /h)	175
NOMİNAL AKIM	0,14 / 0,13
GÜRÜLTÜ SEVİYESİ (db)	42 (46)
AD. / FİYAT	71,16 \$



ÜRÜN KODU	048 095 000602
ÖLÇÜ (mm)	210x210x83
KESİM ÖLÇÜSÜ (mm)	177x177
FAN TİPİ	173x163x51
BESLEME (V AC)	230V-50/60Hz
GÜÇ (W)	37 (35)
HIZ (rpm)	2400
FİLTRELİ (m ³ /h)	175
FİLTRESİZ (m ³ /h)	245
NOMİNAL AKIM	0,23 / 0,22
GÜRÜLTÜ SEVİYESİ (db)	52 (53)
AD. / FİYAT	89,68 \$

FİLTRELİ FANLAR

ÜRÜN KODU	048 095 000603
ÖLÇÜ (mm)	260x260x103
KEŞİM ÖLÇÜSÜ (mm)	223x223
FAN TİPİ	120x120x38
BESLEME (V AC)	230V-50/60Hz
GÜÇ (W)	26 (23)
HIZ (rpm)	2700
FİLTRELİ (m³/h)	115
FİLTRESİZ (m³/h)	130
NOMİNAL AKIM	0,14 / 0,13
GÜRÜLTÜ SEVİYESİ (db)	42 (46)
AD. / FİYAT	76,85 \$



ÜRÜN KODU	048 095 000604
ÖLÇÜ (mm)	260x260x116
KEŞİM ÖLÇÜSÜ (mm)	223x223
FAN TİPİ	172x1263x51
BESLEME (V AC)	230V-50/60Hz
GÜÇ (W)	37 (35)
HIZ (rpm)	2400
FİLTRELİ (m³/h)	240
FİLTRESİZ (m³/h)	270
NOMİNAL AKIM	0,23 / 0,22
GÜRÜLTÜ SEVİYESİ (db)	52 (53)
AD. / FİYAT	102,47 \$



ÜRÜN KODU	048 095 000605
ÖLÇÜ (mm)	260x260x111
KEŞİM ÖLÇÜSÜ (mm)	223x223
FAN TİPİ	225x225x80
BESLEME (V AC)	230V-50/60Hz
GÜÇ (W)	66 (75)
HIZ (rpm)	2600
FİLTRELİ (m³/h)	650
FİLTRESİZ (m³/h)	900
NOMİNAL AKIM	0,35 / 0,38
GÜRÜLTÜ SEVİYESİ (db)	60 (63)
AD. / FİYAT	256,16 \$



ÜRÜN KODU	048 095 000606
ÖLÇÜ (mm)	325x325x145
KEŞİM ÖLÇÜSÜ (mm)	291x291
FAN TİPİ	225x225x80
BESLEME (V AC)	230V-50/60Hz
GÜÇ (W)	66 (75)
HIZ (rpm)	2600
FİLTRELİ (m³/h)	700
FİLTRESİZ (m³/h)	950
NOMİNAL AKIM	0,35 / 0,38
GÜRÜLTÜ SEVİYESİ (db)	60 (63)
AD. / FİYAT	279,88 \$



ÜRÜN KODU	048 095 000607
ÖLÇÜ (mm)	325x325x111
KEŞİM ÖLÇÜSÜ (mm)	291x291
FAN TİPİ	280x280x80
BESLEME (V AC)	230V-50/60Hz
GÜÇ (W)	110 (140)
HIZ (rpm)	2600
FİLTRELİ (m³/h)	850
FİLTRESİZ (m³/h)	1200
NOMİNAL AKIM	0,50 / 0,72
GÜRÜLTÜ SEVİYESİ (db)	65 (68)
AD. / FİYAT	288,42 \$





MINİ ISITICI



PTC ISITICI



SLİM ISITICI

PANO ISITICILARI

Ürün Kodu	Ürün Adı	Besleme	Koruma Sınıfı	Ölçüler (AxBxC)mm	Bağlantı	Adet	Fiyat
048 095 000700	15W PTC PANO ISITICISI	100-250V AC-DC	IP20	60x50x27	KABLO	1	41,95 \$
048 095 000701	25W PTC PANO ISITICISI	100-250V AC-DC	IP20	70x50x27	KABLO	1	49,34 \$
048 095 000702	30W PTC PANO ISITICISI	100-250V AC-DC	IP20	128x70x59	KLEMENS	1	61,67 \$
048 095 000703	50W PTC PANO ISITICISI	100-250V AC-DC	IP20	138x70x59	KLEMENS	1	74 \$
048 095 000704	75W PTC PANO ISITICISI	100-250V AC-DC	IP20	178x70x59	KLEMENS	1	117,19 \$
048 095 000705	100W PTC PANO ISITICISI	100-250V AC-DC	IP20	188x70x59	KLEMENS	1	125,19 \$
048 095 000706	150W PTC PANO ISITICISI	100-250V AC-DC	IP20	228x70x59	KLEMENS	1	141,86 \$
048 095 000707	30W SLIM PTC PANO ISITICISI	100-250V AC-DC	IP20	128x27x80	KLEMENS	1	58,58 \$
048 095 000708	50W SLIM PTC PANO ISITICISI	100-250V AC-DC	IP20	138x27x80	KLEMENS	1	66,62 \$
048 095 000709	75W SLIM PTC PANO ISITICISI	100-250V AC-DC	IP20	178x27x80	KLEMENS	1	108,53 \$
048 095 000710	100W SLIM PTC PANO ISITICISI	100-250V AC-DC	IP20	188x27x80	KLEMENS	1	116,57 \$
048 095 000711	150W SLIM PTC PANO ISITICISI	100-250V AC-DC	IP20	228x27x80	KLEMENS	1	133,2 \$



FANLI PTC ISITICI



FANLI ISITICI



400W PLASTİK FANLI ISITICI

FANLI PANO ISITICILARI

Ürün Kodu	Ürün Adı	Besleme	Koruma Sınıfı	Ölçüler (AxBxC)mm	Bağlantı	Adet	Fiyat
048 095 000800	100W FANLI PTC PANO ISITICISI	230V AC 50/60 Hz	IP20	170x89x60	KLEMENS	1	166,53 \$
048 095 000801	150W FANLI PTC PANO ISITICISI	230V AC 50/60 Hz	IP20	210x89x60	KLEMENS	1	233,1 \$
048 095 000802	250W FANLI REZİSTANS PANO ISITICISI	230V AC 50/60 Hz	IP20	152x110x80	KLEMENS	1	249,77 \$
048 095 000803	500W FANLI REZİSTANS PANO ISITICISI	230V AC 50/60 Hz	IP20	182x110x80	KLEMENS	1	283,68 \$
048 095 000804	750W FANLI REZİSTANS PANO ISITICISI	230V AC 50/60 Hz	IP20	232x110x80	KLEMENS	1	325,01 \$
048 095 000805	200/300/400W FANLI PTC PANO ISITICISI	230V AC 50/60 Hz	IP20	99x70x67	KABLO	1	291,06 \$



Ürün Kodu	Ürün Adı	Kutu Adet	Koli Adet	Fiyat (₺)
-----------	----------	-----------	-----------	-----------

SÜPER ETANJ PLASTİK RAKORLAR C€

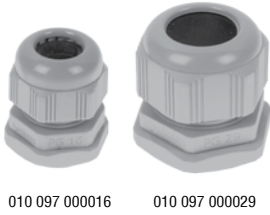

010 097 000007	PG-7 PLASTİK RAKOR	450 ad.	4500	4,87
010 097 000009	PG-9 PLASTİK RAKOR	300 ad.	3000	5,61
010 097 000011	PG-11 PLASTİK RAKOR	200 ad.	2000	7,01
010 097 000135	PG-13,5 PLASTİK RAKOR	175 ad.	1750	7,76
010 097 000016	PG-16 PLASTİK RAKOR	125 ad.	1250	9,36
010 097 000021	PG-21 PLASTİK RAKOR	75 ad.	750	13,61
010 097 000029	PG-29 PLASTİK RAKOR	40 ad.	400	22,6
010 097 000036	PG-36 PLASTİK RAKOR	20 ad.	200	41,92
010 097 000042	PG-42 PLASTİK RAKOR	15 ad.	150	54,23
010 097 000048	PG-48 PLASTİK RAKOR	12 ad.	120	62,23

POLYAMİD SİRAL RAKORU



057 097 110007	PSR-7 SİRAL RAKORU (GRİ-SİYAH)	50 ad.		0,83 €
057 097 110009	PSR-9 SİRAL RAKORU (GRİ-SİYAH)	50 ad.		0,83 €
057 097 110011	PSR-11 SİRAL RAKORU (GRİ-SİYAH)	50 ad.		0,87 €
057 097 110135	PSR-13,5 SİRAL RAKORU (GRİ-SİYAH)	50 ad.		0,99 €
057 097 110016	PSR-16 SİRAL RAKORU (GRİ-SİYAH)	50 ad.		1,07 €
057 097 110021	PSR-21 SİRAL RAKORU (GRİ-SİYAH)	25 ad.		1,49 €
057 097 110029	PSR-29 SİRAL RAKORU (GRİ-SİYAH)	20 ad.		2,48 €
057 097 110036	PSR-36 SİRAL RAKORU (GRİ-SİYAH)	10 ad.		3,51 €
057 097 110048	PSR-48 SİRAL RAKORU (GRİ-SİYAH)	1 ad.		4,74 €

POLYAMİD SİRAL DİRSEĞİ



057 097 120007	PSRD-7 SİRAL RAKORU 90° DİRSEK (GRİ-SİYAH)	1 ad.		1,16 €
057 097 120009	PSRD-9 SİRAL RAKORU 90° DİRSEK (GRİ-SİYAH)	1 ad.		1,24 €
057 097 120011	PSRD-11 SİRAL RAKORU 90° DİRSEK (GRİ-SİYAH)	1 ad.		1,36 €
057 097 120135	PSRD-13,5 SİRAL RAKORU 90° DİRSEK (GRİ-SİYAH)	1 ad.		1,61 €
057 097 120016	PSRD-16 SİRAL RAKORU 90° DİRSEK (GRİ-SİYAH)	1 ad.		1,86 €
057 097 120021	PSRD-21 SİRAL RAKORU 90° DİRSEK (GRİ-SİYAH)	1 ad.		2,97 €

POLYAMİD SİRAL KROŞELERİ



057 097 160007	PG-7 POLYAMİD SİRAL KROŞESİ (GRİ-SİYAH)	50 ad.		0,61 €
057 097 160009	PG-9 POLYAMİD SİRAL KROŞESİ (GRİ-SİYAH)	50 ad.		0,61 €
057 097 160011	PG-11 POLYAMİD SİRAL KROŞESİ (GRİ-SİYAH)	50 ad.		0,61 €
057 097 160135	PG-13,5 POLYAMİD SİRAL KROŞESİ (GRİ-SİYAH)	50 ad.		0,65 €
057 097 160016	PG-16 POLYAMİD SİRAL KROŞESİ (GRİ-SİYAH)	50 ad.		0,69 €
057 097 160021	PG-21 POLYAMİD SİRAL KROŞESİ (GRİ-SİYAH)	25 ad.		0,78 €
057 097 160029	PG-29 POLYAMİD SİRAL KROŞESİ (GRİ-SİYAH)	25 ad.		1,47 €
057 097 160036	PG-36 POLYAMİD SİRAL KROŞESİ (GRİ-SİYAH)	25 ad.		2,25 €
057 097 160048	PG-48 POLYAMİD SİRAL KROŞESİ (GRİ-SİYAH)	10 ad.		3,12 €

PP POLYPROPİLEN SİRALLER C€

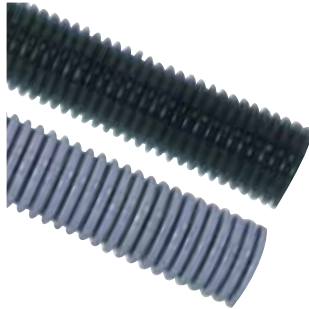

	Rakor Ölçüsü	Ort. İç Çap	Ort. Dış Çap				
001 020 160007 00 XX	MUT/PP-7 PP SİRAL BORU	PSR7	7	10,1	100 mt.	1000	4,34
001 020 160009 00 XX	MUT/PP-8,5 PP SİRAL BORU		8,4	12,05	100 mt.	1000	4,64
001 020 160010 00 XX	MUT/PP-10 PP SİRAL BORU	PSR9	10,2	13,1	100 mt.	1000	5,05
001 020 160012 00 XX	MUT/PP-12 PP SİRAL BORU	PSR11	12,3	15,9	50 mt.	500	7,01
001 020 160014 00 XX	MUT/PP-14 PP SİRAL BORU	PSR13,5	14,1	18,35	50 mt.	250	8,48
001 020 160017 00 XX	MUT/PP-17 PP SİRAL BORU	PSR16	17	21,45	50 mt.	250	10,46
001 020 160019 00 XX	MUT/PP-19 PP SİRAL BORU		19	24,25	50 mt.	250	11,63
001 020 160023 00 XX	MUT/PP-23 PP SİRAL BORU	PSR21	23,25	28,5	50 mt.	250	13,37
001 020 160026 00 XX	MUT/PP-26 PP SİRAL BORU		26,2	31,3	25 mt.	125	15
001 020 160029 00 XX	MUT/PP-29 PP SİRAL BORU	PSR29	29,1	34,3	25 mt.	125	16,61
001 020 160036 00 XX	MUT/PP-36 PP SİRAL BORU	PSR36	35,8	42,2	25 mt.	125	23,9
001 020 160048 00 XX	MUT/PP-48 PP SİRAL BORU	PSR48	48,5	54,5	25 mt.	125	30,71

PA6 POLYAMİD SİRALLER (ALEV YAYMAYAN) C€



001 020 170007 00 XX	MUT/PA6-7 (A. YAYMAYAN)	PSR7	7	10,1	100 mt.	1000	7,69
001 020 170009 00 XX	MUT/PA6-8,5 (A. YAYMAYAN)		8,4	12,05	100 mt.	1000	8,32
001 020 170010 00 XX	MUT/PA6-10 (A. YAYMAYAN)	PSR9	10,2	13,1	100 mt.	1000	9,08
001 020 170012 00 XX	MUT/PA6-12 (A. YAYMAYAN)	PSR11	12,3	15,9	50 mt.	500	14,4
001 020 170014 00 XX	MUT/PA6-14 (A. YAYMAYAN)	PSR13,5	14,1	18,35	50 mt.	250	18,09
001 020 170017 00 XX	MUT/PA6-17 (A. YAYMAYAN)	PSR16	17	21,45	50 mt.	250	22,21
001 020 170019 00 XX	MUT/PA6-19 (A. YAYMAYAN)		19	24,25	50 mt.	250	27,97
001 020 170023 00 XX	MUT/PA6-23 (A. YAYMAYAN)	PSR21	23,25	28,5	50 mt.	250	30,85
001 020 170026 00 XX	MUT/PA6-26 (A. YAYMAYAN)		26,2	31,3	25 mt.	125	32,9
001 020 170029 00 XX	MUT/PA6-29 (A. YAYMAYAN)	PSR29	29,1	34,3	25 mt.	125	40,85
001 020 170036 00 XX	MUT/PA6-36 (A. YAYMAYAN)	PSR36	36,2	42,2	25 mt.	125	68,8
001 020 170048 00 XX	MUT/PA6-48 (A. YAYMAYAN)	PSR48	48,5	54,5	25 mt.	125	79,98

POLYAMİD YARIKLI SİRAL BORU (ALEV YAYMAYAN)



001 020 470007 00 XX	Ø7 POLYAMİD YARIKLI SİRAL BORU(ALEV YAYMAYAN)				100 mt.	1000	8,6
001 020 470009 00 XX	Ø8,5 POLYAMİD YARIKLI SİRAL BORU(ALEV YAYMAYAN)				100 mt.	1000	9,55
001 020 470010 00 XX	Ø10 POLYAMİD YARIKLI SİRAL BORU(ALEV YAYMAYAN)				100 mt.	1000	10,5
001 020 470012 00 XX	Ø12 POLYAMİD YARIKLI SİRAL BORU(ALEV YAYMAYAN)				100 mt.	500	16,72
001 020 470014 00 XX	Ø14 POLYAMİD YARIKLI SİRAL BORU(ALEV YAYMAYAN)				50 mt.	250	21,02
001 020 470017 00 XX	Ø17 POLYAMİD YARIKLI SİRAL BORU(ALEV YAYMAYAN)				50 mt.	250	25,79
001 020 470019 00 XX	Ø19 POLYAMİD YARIKLI SİRAL BORU(ALEV YAYMAYAN)				50 mt.	250	32,47
001 020 470023 00 XX	Ø23 POLYAMİD YARIKLI SİRAL BORU(ALEV YAYMAYAN)				50 mt.	250	35,82
001 020 470026 00 XX	Ø26 POLYAMİD YARIKLI SİRAL BORU(ALEV YAYMAYAN)				25 mt.	125	38,21
001 020 470029 00 XX	Ø29 POLYAMİD YARIKLI SİRAL BORU(ALEV YAYMAYAN)				25 mt.	125	45,37
001 020 470036 00 XX	Ø36 POLYAMİD YARIKLI SİRAL BORU(ALEV YAYMAYAN)				25 mt.	125	76,4
001 020 470048 00 XX	Ø48 POLYAMİD YARIKLI SİRAL BORU(ALEV YAYMAYAN)				25 mt.	125	88,83

KABLO BAĞLARI

Kendinden Kilitlemeli Sistem
Kolay ve Hızlı Montaj
1.Sınıf Malzeme



STANDART TİP

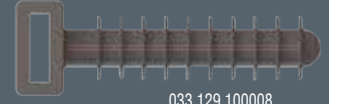

033 129 10008



062 129 171009



062 129 171011



062 129 132020
062 129 132828

062 129 500003

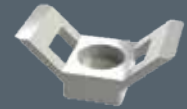

062 129 151530

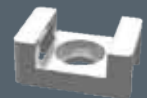

062 129 151017
062 129 151723



062 129 142525 062 129 132525 062 129 191325

Beyaz Ürün Kodu	Siyah Ürün Kodu		Ürün Adı	Kutu Adet	Koli Adet	Fiyat (₺)
MUTLUSAN KABLO BAĞLARI (SİYAH-BEYAZ) CE						
062 129 025100	062 129 125100	2,5x100	KABLO BAĞI	1000 ad.	80000	0,191
062 129 025140	062 129 125140	2,5x140	KABLO BAĞI	100 ad.	50000	0,285
062 129 025200	062 129 125200	2,5x200	KABLO BAĞI	100 ad.	35000	0,416
062 129 036150	062 129 136150	3,6x150	KABLO BAĞI	100 ad.	30000	0,484
062 129 036205	062 129 136205	3,6x205	KABLO BAĞI	100 ad.	25000	0,633
062 129 036250	062 129 136250	3,6x250	KABLO BAĞI	100 ad.	22500	0,769
062 129 036300	062 129 136300	3,6x300	KABLO BAĞI	100 ad.	17500	0,943
062 129 036370	062 129 136370	3,6x370	KABLO BAĞI	100 ad.	16000	1,202
062 129 048200	062 129 148200	4,8x200	KABLO BAĞI	100 ad.	17000	0,935
062 129 048250	062 129 148250	4,8x250	KABLO BAĞI	100 ad.	15000	1,135
062 129 048300	062 129 148300	4,8x300	KABLO BAĞI	100 ad.	15000	1,415
062 129 048350	062 129 148350	4,8x350	KABLO BAĞI	100 ad.	12000	1,625
062 129 048400	062 129 148400	4,8x400	KABLO BAĞI	100 ad.	10000	1,847
062 129 048450	062 129 148450	4,8x450	KABLO BAĞI	100 ad.	10000	2,199
062 129 008250	062 129 108250	8x250	KABLO BAĞI	100 ad.	8000	2,266
062 129 008300	062 129 108300	8x300	KABLO BAĞI	100 ad.	6000	2,938
062 129 008380	062 129 108380	8x380	KABLO BAĞI	100 ad.	6000	3,191
062 129 008450	062 129 108450	8x450	KABLO BAĞI	100 ad.	5000	3,570
062 129 008550	062 129 108550	8x550	KABLO BAĞI	100 ad.	4000	4,785
062 129 008750	062 129 108750	8x750	KABLO BAĞI	100 ad.	2000	7,651
062 129 009762	062 129 109762	9x762	KABLO BAĞI	100 ad.	1500	10,202
062 129 009940	062 129 109940	9x940	KABLO BAĞI	100 ad.	1500	11,791



BONCUK KELEPÇE



062 129 161004



060 120 005105

060 120 017117

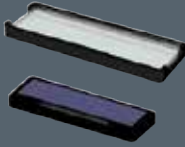

YAPIŞKAN PANO ETİKETLERİ



062 129 111035
062 129 112045



XX: 00 -ŞEFFAF

XX: 11 -SİYAH



Ürün Kodu	Ürün Adı	Kutu Adet	Koli Adet	Fiyat (₺)
-----------	----------	-----------	-----------	-----------

KROŞE VE KLİPSLER

062 129 132020	20x20 YAPIŞKANLI KROŞE	100 ad.	25000	0,875
062 129 132828	28x28 YAPIŞKANLI KROŞE	100 ad.	12500	1,474
062 129 131316	13x16 YAPIŞKANLI KLİPS	100 ad.	7000	0,918
062 129 191325	13x25 YAPIŞKANLI KLİPS	100 ad.	5000	1,185
062 129 132525	25x25 YAPIŞKANLI KLİPS (BEYAZ)	100 ad.	3000	1,878
062 129 142525	25x25 YAPIŞKANLI KLİPS (SİYAH)	100 ad.	2000	2,005
062 129 151017	10x17 VİDALI KROŞE	250 ad.	12500	0,656
062 129 151530	15x30 VİDALI KROŞE	100 ad.	5000	1,103
062 129 151723	17x23 VİDALI KROŞE	250 ad.	5000	0,949
062 129 161004	DÜBELLİ KROŞE 6 DELİK İÇİN	500 ad.	15000	0,526
062 129 171009	DUVAR KROŞESİ 6 DELİK İÇİN	250 ad.	7500	0,917
033 129 100008	DUVAR KROŞESİ 8 DELİK İÇİN	250 ad.	4000	1,173
062 129 171011	KANAL KROŞESİ 6 DELİK İÇİN	250 ad.	7500	0,889
062 129 500003	KABLO KLİPSİ 6,4 (1/4")	100 ad.		0,596
062 129 500004	KABLO KLİPSİ 7,9 (5/16")	100 ad.		0,679
062 129 500005	KABLO KLİPSİ 10,9 (3/8")	100 ad.		0,721

KELEPÇELER

062 129 010101	2x105	BONCUK KELEPÇE	1000 ad.	25000	0,246
062 129 010102	3,5x165	BONCUK KELEPÇE	500 ad.	8000	0,574
062 129 500000	3,5x235	BONCUK KELEPÇE	100 ad.	5000	0,896
060 120 005105	EA.05.105	BURMA KELEPÇE	500 ad.	70000	0,363
060 120 007107	EA.07.107	BURMA KELEPÇE	500 ad.	60000	0,382
060 120 010110	EA.10.110	BURMA KELEPÇE	500 ad.	50000	0,484
060 120 014114	EA.14.114	BURMA KELEPÇE	500 ad.	40000	0,498
060 120 017117	EA.17.117	BURMA KELEPÇE	500 ad.	25000	0,582

ETİKETLER

062 129 111035	10X35 KABLO BAĞI ETİKETİ	100 ad.	4000	1,522
062 129 112045	20X45 KABLO BAĞI ETİKETİ	100 ad.	1500	2,736
062 129 121730	17X30 YAPIŞKANLI PANO ETİKETİ	100 ad.	5000	1,773
062 129 121750	17X50 YAPIŞKANLI PANO ETİKETİ	50 ad.	3000	2,373
062 129 122075	17X75 YAPIŞKANLI PANO ETİKETİ	25 ad.	1500	3,248

HELEZON PANO SİRALİ

		İç Çap	Dış Çap			
001 020 500001 05 XX	NO.1 PANO SİRALİ (50cm)	5	6	100 ad.	4000	1,82
001 020 500002 05 XX	NO.2 PANO SİRALİ (50cm)	7	8	100 ad.	3000	2,63
001 020 500003 05 XX	NO.3 PANO SİRALİ (50cm)	10	11	100 ad.	2000	3,30
001 020 500004 05 XX	NO.4 PANO SİRALİ (50cm)	13	14	50 ad.	800	7,22
001 020 500005 05 XX	NO.5 PANO SİRALİ (50cm)	16	17	25 ad.	800	7,52

HELEZON PANO SİRALİ (RULO)

001 020 600001 00 XX	NO.1 PANO SİRALİ (100cm)	5	6	100 mt.	4000	3,8
001 020 600002 00 XX	NO.2 PANO SİRALİ (100cm)	7	8	100 mt.	3000	4,94
001 020 600003 00 XX	NO.3 PANO SİRALİ (100cm)	10	11	100 mt.	2000	6,61
001 020 600004 00 XX	NO.4 PANO SİRALİ (100cm)	13	14	50 mt.	800	14,43
001 020 600005 00 XX	NO.5 PANO SİRALİ (100cm)	16	17	50 mt.	800	15,03

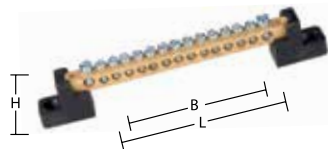
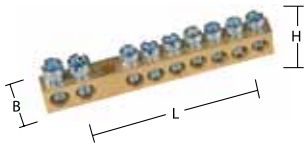

RAY KLEMENSLER - VİDALI

Ürün Kodu	Ürün Adı	Kutu Adet	Fiyat (₺)
010 094 000025	2,5 mm RAY KLEMENSİ	100	12,65
010 094 000004	4 mm RAY KLEMENSİ	100	13,55
010 094 000006	6 mm RAY KLEMENSİ	100	21,69
010 094 000010	10 mm RAY KLEMENSİ	100	27,11
010 094 000016	16 mm RAY KLEMENSİ	30	45,18
010 094 000035	35 mm RAY KLEMENSİ	20	80,87
010 094 010001	KLEMENS DURDURUCU	100	12,24

RAY KLEMENSLER - TOPRAKLAMALI

Ürün Kodu	Ürün Adı	Kutu Adet	Fiyat (₺)
010 094 010003	2.5 mm TOPRAKLAMALI RAY KLEMENSİ	100	49,24
010 094 010008	4 mm TOPRAKLAMALI RAY KLEMENSİ	100	56,47
010 094 010004	6 mm TOPRAKLAMALI RAY KLEMENSİ	100	79,97
010 094 010009	10 mm TOPRAKLAMALI RAY KLEMENSİ	100	83,58
010 094 010005	16 mm TOPRAKLAMALI RAY KLEMENSİ	30	130,11
010 094 010010	35 mm TOPRAKLAMALI RAY KLEMENSİ	20	174,39

YAY BASKILI RAY KLEMENSLER

Ürün Kodu	Ürün Adı	Kutu Adet	Fiyat (₺)
010 094 010011	2,5 mm RAY KLEMENSİ (YAY BASKILI)	100	14,46
010 094 010012	4 mm RAY KLEMENSİ (YAY BASKILI)	100	19,43
010 094 010013	6 mm RAY KLEMENSİ (YAY BASKILI)	100	36,14
010 094 010014	10 mm RAY KLEMENSİ (YAY BASKILI)	100	40,21

SİGORTALI RAY KLEMENSLER

Ürün Kodu	Ürün Adı	Kutu Adet	Fiyat (₺)
010 094 000051	SİGORTALI RAY KLEMENS	75	92,62

DEKAFİX

Ürün Kodu	Ürün Adı	Kutu Adet	Fiyat (₺)
010 094 010006	YAZILI DEKAFİX (1 ADET FİYATI)	500	0,92
010 094 010007	YAZISIZ DEKAFİX (1 ADET FİYATI)	500	0,71

PANO TOPRAKLAMA KLEMENSLERİ (6x8 mm) 63A

Ürün Kodu	Ürün Adı	L	B	H	Kutu Adet	Fiyat (₺)
014 102 006304	4 DELİK PANO TOPRAKLAMA KLEMENS	6	8	33	1500	17,89
014 102 006305	5 DELİK PANO TOPRAKLAMA KLEMENS	6	8	38	1500	18,98
014 102 006306	6 DELİK PANO TOPRAKLAMA KLEMENS	6	8	45	1250	25,35
014 102 006307	7 DELİK PANO TOPRAKLAMA KLEMENS	6	8	50	1000	26,7
014 102 006309	9 DELİK PANO TOPRAKLAMA KLEMENS	6	8	62	1000	29,82
014 102 006310	10 DELİK PANO TOPRAKLAMA KLEMENS	6	8	68	750	33,88
014 102 006312	12 DELİK PANO TOPRAKLAMA KLEMENS	6	8	80	750	43,37

PANO TOPRAKLAMA KLEMENSLERİ AYAKLI (6,5X9 mm) 80A

Ürün Kodu	Ürün Adı	L	B	H	Kutu Adet	Fiyat (₺)
014 102 008006	6 DELİK AYAKLI DAĞITIM ÜNİTESİ	85	70	22	200	40,45
014 102 008010	10 DELİK AYAKLI DAĞITIM ÜNİTESİ	108	95	22	150	54,45
014 102 008012	12 DELİK AYAKLI DAĞITIM ÜNİTESİ	120	106	22	150	58,34
014 102 008015	15 DELİK AYAKLI DAĞITIM ÜNİTESİ	138	124	22	125	70,01
014 102 008020	20 DELİK AYAKLI DAĞITIM ÜNİTESİ	165	152	22	100	93,34

1 KUTUP DAĞITIM ÜNİTESİ 125A

Ürün Kodu	Ürün Adı	Çinsi	L	B	H	Koli Adet	Fiyat (₺)
014 102 112507	125 A. 1 KUTUP DAĞITIM ÜNİTESİ	2+5	76	44	42	70	92,05
014 102 112510	125 A. 1 KUTUP DAĞITIM ÜNİTESİ	2+8	100	44	42	60	107,6
014 102 112512	125 A. 1 KUTUP DAĞITIM ÜNİTESİ	2+10	115	44	42	55	127,05
014 102 112515	125 A. 1 KUTUP DAĞITIM ÜNİTESİ	2+13	135	44	42	45	142,61
014 102 112520	125 A. 1 KUTUP DAĞITIM ÜNİTESİ	2+18	170	44	42	35	199,65
014 102 112522	125 A. 1 KUTUP DAĞITIM ÜNİTESİ	2+20	185	44	42	30	220,39

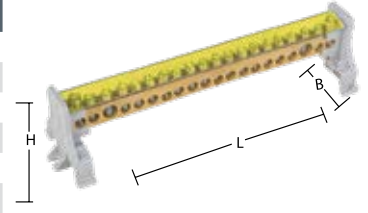

2 KUTUP DAĞITIM ÜNİTESİ 125A

Ürün Kodu	Ürün Adı	Çinsi	L	B	H	Koli Adet	Fiyat (₺)
014 102 212507	125 A. 2 KUTUP DAĞITIM ÜNİTESİ	2+5	81	90	50	20	189,8
014 102 212510	125 A. 2 KUTUP DAĞITIM ÜNİTESİ	2+8	103	90	50	16	211,58
014 102 212512	125 A. 2 KUTUP DAĞITIM ÜNİTESİ	2+10	118	90	50	12	235,95
014 102 212515	125 A. 2 KUTUP DAĞITIM ÜNİTESİ	2+13	142	90	50	10	304,66
014 102 212520	125 A. 2 KUTUP DAĞITIM ÜNİTESİ	2+18	178	90	50	8	388,93

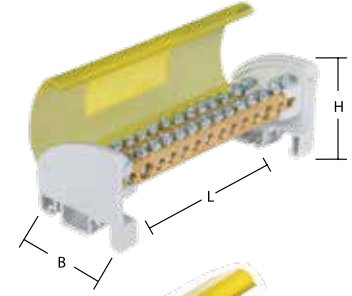

4 KUTUP DAĞITIM ÜNİTESİ 125A

Ürün Kodu	Ürün Adı	Çinsi	L	B	H	Koli Adet	Fiyat (₺)
014 102 412507	125 A. 4 KUTUP DAĞITIM ÜNİTESİ	2+5	60	80	75	10	375,96
014 102 412510	125 A. 4 KUTUP DAĞITIM ÜNİTESİ	2+8	83	80	75	8	404,49
014 102 412512	125 A. 4 KUTUP DAĞITIM ÜNİTESİ	2+10	97	80	75	6	453,75
014 102 412515	125 A. 4 KUTUP DAĞITIM ÜNİTESİ	2+13	120	80	75	5	560,06
014 102 412520	125 A. 4 KUTUP DAĞITIM ÜNİTESİ	2+18	155	80	75	4	731,19
014 102 412522	125 A. 4 KUTUP DAĞITIM ÜNİTESİ	2+20	170	80	75	4	777,86
014 102 412525	125 A. 4 KUTUP DAĞITIM ÜNİTESİ	2+23	191	80	75	4	902,31

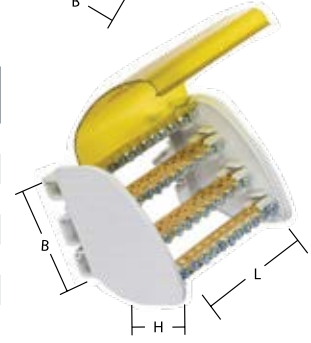

3 KUTUP DAĞITIM ÜNİTESİ (10x15) 160A

Ürün Kodu	Ürün Adı	Çinsi	L	B	H	Koli Adet	Fiyat (₺)
014 102 316007	160 A. 3 KUTUP DAĞITIM ÜNİTESİ	2+5	105	130	55	12	606,73
014 102 316010	160 A. 3 KUTUP DAĞITIM ÜNİTESİ	2+8	145	130	55	8	902,31
014 102 316012	160 A. 3 KUTUP DAĞITIM ÜNİTESİ	2+10	165	130	55	8	1.078,63
014 102 316015	160 A. 3 KUTUP DAĞITIM ÜNİTESİ	2+13	200	130	55	6	1.322,36
014 102 316020	160 A. 3 KUTUP DAĞITIM ÜNİTESİ	2+18	255	130	55	4	1.804,63
014 102 316022	160 A. 3 KUTUP DAĞITIM ÜNİTESİ	2+20	275	130	55	4	1.983,54

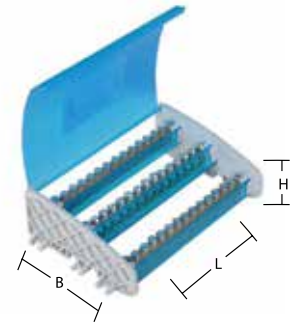

4 KUTUP DAĞITIM ÜNİTESİ (10x15) 160A

Ürün Kodu	Ürün Adı	Çinsi	L	B	H	Koli Adet	Fiyat (₺)
014 102 416007	160 A. 4 KUTUP DAĞITIM ÜNİTESİ	2+5	105	144	55	12	692,29
014 102 416010	160 A. 4 KUTUP DAĞITIM ÜNİTESİ	2+8	145	144	55	8	1.011,21
014 102 416012	160 A. 4 KUTUP DAĞITIM ÜNİTESİ	2+10	165	144	55	8	1.197,9
014 102 416015	160 A. 4 KUTUP DAĞITIM ÜNİTESİ	2+13	200	144	55	6	1.493,49
014 102 416020	160 A. 4 KUTUP DAĞITIM ÜNİTESİ	2+18	255	144	55	4	1.944,64
014 102 416022	160 A. 4 KUTUP DAĞITIM ÜNİTESİ	2+20	275	144	55	4	2.022,43

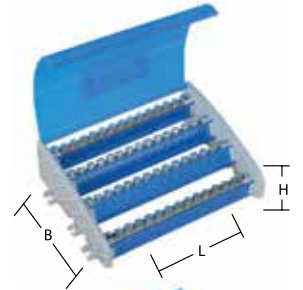

5 KUTUP DAĞITIM ÜNİTESİ (10x15) 160A

Ürün Kodu	Ürün Adı	Çinsi	L	B	H	Koli Adet	Fiyat (₺)
014 102 516007	160 A. 5 KUTUP DAĞITIM ÜNİTESİ	2+5	105	151	95	8	840,09
014 102 516010	160 A. 5 KUTUP DAĞITIM ÜNİTESİ	2+8	145	151	95	4	1.192,71
014 102 516012	160 A. 5 KUTUP DAĞITIM ÜNİTESİ	2+10	165	151	95	4	1.426,07
014 102 516015	160 A. 5 KUTUP DAĞITIM ÜNİTESİ	2+13	200	151	95	4	1.789,07
014 102 516020	160 A. 5 KUTUP DAĞITIM ÜNİTESİ	2+18	255	151	95	4	2.372,46
014 102 516022	160 A. 5 KUTUP DAĞITIM ÜNİTESİ	2+20	275	151	95	4	2.592,86

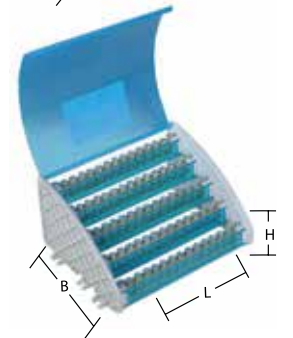

GEÇMELİ TİP ve TIRNAKLI TİP BUAT KLEMENSLER

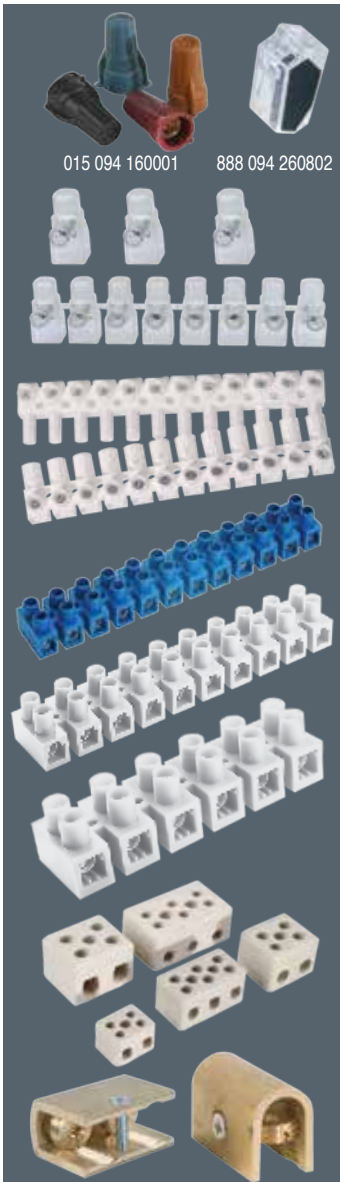

Ürün Kodu	Ürün Adı	Kutu Adet	Koli Adet	Fiyat (₺)
SWISS GEÇMELİ BUAT KLEMENS				
999 094 225000	2'Lİ GEÇMELİ BUAT KLEMENS (0,5-4 mm ²)	100	6000	0,149 \$
999 094 325000	3'LÜ GEÇMELİ BUAT KLEMENS (0,5-4 mm ²)	100	6000	0,264 \$
999 094 425000	4'LÜ GEÇMELİ BUAT KLEMENS (0,5-4 mm ²)	100	6000	0,304 \$
999 094 525000	5'Lİ GEÇMELİ BUAT KLEMENS (0,5-4 mm ²)	100	6000	0,329 \$
SWISS TIRNAKLI BUAT KLEMENS				
999 094 241000	2'Lİ TIRNAKLI BUAT KLEMENS (0,5-2,5 mm ²)	100	2400	0,464 \$
999 094 341000	3'LÜ TIRNAKLI BUAT KLEMENS (0,5-2,5 mm ²)	100	2400	0,606 \$
999 094 541000	5'Lİ TIRNAKLI BUAT KLEMENS (0,5-2,5 mm ²)	50	1200	0,959 \$
GEÇMELİ BUAT KLEMENSLERİ				
888 094 260802	BM802 GEÇMELİ BUAT KLEMENSİ (2'Lİ)	400	6400	0,149 \$
015 094 160001	NO. 2 ZEYTİN (BUAT) KLEMENS	1000		1,63
ŞEFFAF ISIYA DAYANIKLI BUAT KLEMENSLER				
888 094 000105	NO.2 ŞEFFAF BUAT KLEMENS (1 ADET FİYAT)		560	3,75
888 094 000205	NO.3 ŞEFFAF BUAT KLEMENS (1 ADET FİYAT)		360	5,29
888 094 000405	NO.4 ŞEFFAF BUAT KLEMENS (1 ADET FİYAT)		200	8,67
888 094 000605	NO.5 ŞEFFAF BUAT KLEMENS (1 ADET FİYAT)		120	11,75
GEÇMELİ SOKET KLEMENSLER				
999 999 991212	12'Lİ GEÇMELİ SOKET KLEMENS	25	500	135,54
PLASTİK SIRA KLEMENSLER				
015 094 150001	NO. 1 SIRA KLEMENSLER (2,5-4 mm ²)	50	1000	35,24
015 094 150002	NO. 2 SIRA KLEMENSLER (4-6 mm ²)	50	800	44,68
015 094 150003	NO. 3 SIRA KLEMENSLER (6-10 mm ²)	50	400	56,29
015 094 150004	NO. 4 SIRA KLEMENSLER (10-16 mm ²)	50	400	61,22
015 094 150005	NO. 5 SIRA KLEMENSLER (16-25 mm ²)	50	400	67,09
ISIYA DAYANIKLI SIRA KLEMENSLER				
015 094 170001	NO. 1 ISIYA DAYANIKLI KLEMENSLER (2,5-4 mm ²)	50	1000	36,64
015 094 170002	NO. 2 ISIYA DAYANIKLI KLEMENSLER (4-6 mm ²)	50	800	48,34
015 094 170003	NO. 3 ISIYA DAYANIKLI KLEMENSLER (6-10 mm ²)	50	400	61,22
015 094 170004	NO. 4 ISIYA DAYANIKLI KLEMENSLER (10-16 mm ²)	50	400	67,09
015 094 170005	NO. 5 ISIYA DAYANIKLI KLEMENSLER (16-25 mm ²)	50	400	74,32
PORSELEN KLEMENSLER				
015 094 180002	NO. 1-2'Lİ PORSELEN KLEMENS (2,5-4 mm ²)	396		13,20
015 094 180003	NO. 1-3'LÜ PORSELEN KLEMENS (2,5-4 mm ²)	220		15,88
015 094 180004	NO. 2-2'Lİ PORSELEN KLEMENS (4-6 mm ²)	200		16,29
015 094 180005	NO. 2-3'LÜ PORSELEN KLEMENS (4-6 mm ²)	150		23,72
015 094 180006	NO. 3-2'Lİ PORSELEN KLEMENS (6-10 mm ²)	104		23,97
015 094 180007	NO. 3-3'LÜ PORSELEN KLEMENS (6-10 mm ²)	64		29,12
U KLEMENSLER				
014 094 030006	6'LİK U KLEMENS	300		22,73
014 094 030010	10'LÜK U KLEMENS	250		33,76
014 094 030016	16'LİK U KLEMENS	100		45,19
014 094 030025	25'LİK U KLEMENS	100		51,82
014 094 030035	35'LİK U KLEMENS	75		61,62
014 094 030050	50'LİK U KLEMENS	50		95,79
014 094 030070	70'LİK U KLEMENS	40		106,4
014 094 030095	95'LİK U KLEMENS	25		152,05
014 094 030120	120'LİK U KLEMENS	20		179,23
014 094 030150	150'LİK U KLEMENS	15		268,85

Ürün Kodu	Ürün Adı	Kutu Adet	Koli Adet	Fiyat (₺)
İZOLELİ TEK GİRİŞLİ YÜKSÜK				
014 100 010508	ITY-0508 İZO.TEK GİRİŞ. YÜKSÜK 0,50 mm	1000		0,281
014 100 017508	ITY-7508 İZO.TEK GİRİŞ. YÜKSÜK 0,75 mm	1000		0,281
014 100 011008	ITY-1008 İZO.TEK GİRİŞ. YÜKSÜK 1,00 mm	1000		0,281
014 100 011508	ITY-1508 İZO.TEK GİRİŞ. YÜKSÜK 1,50 mm	1000		0,305
014 100 012508	ITY-2508 İZO.TEK GİRİŞ. YÜKSÜK 2,50 mm	500		0,391
014 100 014009	ITY-4009 İZO.TEK GİRİŞ. YÜKSÜK 4,00 mm	500		0,660
014 100 016012	ITY-6012 İZO.TEK GİRİŞ. YÜKSÜK 6,00 mm	250		0,875
014 100 011012	ITY-1012 İZO.TEK GİRİŞ. YÜKSÜK 10,00 mm	100		1,106
014 100 011612	ITY-1612 İZO.TEK GİRİŞ. YÜKSÜK 16,00 mm	100		1,568
014 100 012516	ITY-2516 İZO.TEK GİRİŞ. YÜKSÜK 25,00 mm	50		2,640
014 100 013516	ITY-3516 İZO.TEK GİRİŞ. YÜKSÜK 35,00 mm	40		3,300
014 100 015020	ITY-5020 İZO.TEK GİRİŞ. YÜKSÜK 50,00 mm	25		6,105
İZOLELİ ÇİFT GİRİŞLİ YÜKSÜK				
014 100 020508	ICY-0508 İZO.ÇİFT GİRİŞ. YÜKSÜK 2x0,5 mm	1000		0,495
014 100 027508	ICY-7508 İZO.ÇİFT GİRİŞ. YÜKSÜK 2x0,75 mm	500		0,520
014 100 021008	ICY-1008 İZO.ÇİFT GİRİŞ. YÜKSÜK 2x1 mm	500		0,553
014 100 021508	ICY-1508 İZO.ÇİFT GİRİŞ. YÜKSÜK 2x1,5 mm	500		0,668
014 100 022510	ICY-2510 İZO.ÇİFT GİRİŞ. YÜKSÜK 2x2,5 mm	250		1,089
014 100 024012	ICY-4012 İZO.ÇİFT GİRİŞ. YÜKSÜK 2x4 mm	200		1,218
014 100 026014	ICY-6014 İZO.ÇİFT GİRİŞ. YÜKSÜK 2x6 mm	100		1,551
İZOLELİ YUVARLAK TİP PABUÇ				
014 100 030154	IYP-1,5-4 İZO.YUV.TİP PAB. 0,5-1,5 mm(M4)	200		1,320
014 100 030155	IYP-1,5-5 İZO.YUV.TİP PAB. 0,5-1,5 mm(M5)	200		1,337
014 100 030156	IYP-1,5-6 İZO.YUV.TİP PAB. 0,5-1,5 mm(M6)	200		2,096
014 100 030158	IYP-1,5-8 İZO.YUV.TİP PAB. 0,5-1,5 mm(M8)	200		2,145
014 100 030254	IYP-2,5-4 İZO.YUV.TİP PAB. 1,5-2,5 mm(M4)	200		1,617
014 100 030255	IYP-2,5-5 İZO.YUV.TİP PAB. 1,5-2,5 mm(M5)	200		1,650
014 100 030256	IYP-2,5-6 İZO.YUV.TİP PAB. 1,5-2,5 mm(M6)	200		2,343
014 100 030258	IYP-2,5-8 İZO.YUV.TİP PAB. 1,5-2,5 mm(M8)	200		2,343
014 100 036004	IYP-6-4 İZO.YUV.TİP PAB. 4-6 mm(M4)	100		3,416
014 100 036005	IYP-6-5 İZO.YUV.TİP PAB. 4-6 mm(M5)	100		3,416
014 100 036006	IYP-6-6 İZO.YUV.TİP PAB. 4-6 mm(M6)	100		3,845
014 100 036008	IYP-6-8 İZO.YUV.TİP PAB. 4-6 mm(M8)	100		4,868
İZOLELİ ÇATAL TİP PABUÇ				
014 100 040154	ICP-1,5-4 İZO.ÇTL.TİP PAB. 0,5-1,5 mm(M4)	200		1,238
014 100 040155	ICP-1,5-5 İZO.ÇTL.TİP PAB. 0,5-1,5 mm(M5)	200		1,254
014 100 040156	ICP-1,5-6 İZO.ÇTL.TİP PAB. 0,5-1,5 mm(M6)	200		1,419
014 100 040254	ICP-2,5-4 İZO.ÇTL.TİP PAB. 1,5-2,5 mm(M4)	200		1,337
014 100 040255	ICP-2,5-5 İZO.ÇTL.TİP PAB. 1,5-2,5 mm(M5)	200		1,353
014 100 040256	ICP-2,5-6 İZO.ÇTL.TİP PAB. 1,5-2,5 mm(M6)	200		1,815
014 100 046004	ICP-6-4 İZO.ÇTL.TİP PAB. 4-6 mm(M4)	100		2,987
014 100 046005	ICP-6-5 İZO.ÇTL.TİP PAB. 4-6 mm(M5)	100		3,003
014 100 046006	ICP-6-6 İZO.ÇTL.TİP PAB. 4-6 mm(M6)	100		4,076
İZOLELİ İĞNE TİP TERMİNAL				
014 100 050015	IIT-1,5 İZOLELİ İĞNE TİP TERM.0,5-1,5 mm	200		1,370
014 100 050025	IIT-2,5 İZOLELİ İĞNE TİP TERM.1,5-2,5 mm	200		1,650
014 100 050040	IIT-4 İZOLELİ İĞNE TİP TERM.4-6 mm	100		3,960
İZOLELİ EK MUF				
014 100 070015	IEM-1,5 İZOLELİ EK MUF 0,5-1,5 mm	200		1,815
014 100 070025	IEM-2,5 İZOLELİ EK MUF 1,5-2,5 mm	200		1,898
014 100 070040	IEM-4 İZOLELİ EK MUF 4-6 mm	100		3,135
İZOLELİ FASTON ERKEK TERMİNAL				
014 100 060015	IFE-1,5 İZO. FASTON ERK. TERM. 1,5 mm	200		1,190
014 100 060025	IFE-2,5 İZO. FASTON ERK. TERM. 2,5 mm	200		1,313
014 100 060040	IFE-4 İZO. FASTON ERK. TERM. 4 mm	200		1,557
İZOLELİ FASTON DIŞI TERMİNAL				
014 100 080510	IDT-0,5-1 YARIM İZO. DIŞI TERM.0,5-1MM	100		1,417
014 100 081525	IDT-1,5-2,5 YARIM İZO. DIŞI TERM.1,5-2,5MM	100		1,417
014 100 084060	IDT-4-6 YARIM İZO. DIŞI TERM.4-6 MM	100		1,766
TAM İZOLELİ DIŞI TERMİNAL				
014 100 090510	TDT-0,5-1 TAM İZO.DIŞI TERM. 0,5-1 mm	100		1,922
014 100 091525	TDT-1,5-2,5 TAM İZO.DIŞI TERM.1,5-2,5 mm	100		1,922
014 100 094060	TDT-4-6 TAM İZO.DIŞI TERM. 4-6 mm	100		2,098
YUVARLAK DIŞI TERMİNAL				
014 100 100510	YDT-0,5-1 YUV. DIŞI TERM. 0,5-1 mm	200		3,713
014 100 101525	YDT-1,5-2,5 YUV. DIŞI TERM. 1,5-2,5 mm	100		4,125
014 100 104060	YDT-4-6 YUV. DIŞI TERM. 4-6 mm	100		5,115
YUVARLAK ERKEK TERMİNAL				
014 100 110510	YET-0,5-1 YUV. ERKEK TERM. 0,5-1 mm	200		3,135
014 100 111525	YET-1,5-2,5 YUV. ERKEK TERM.1,5-2,5 mm	200		3,465
014 100 114060	YET-4-6 YUV. ERKEK TERM. 4-6 mm	200		4,703
FASTON TİP TERMİNALLER İZOLESİZ				
065 100 140003	TSF-1-D 6,3 FASTON TİP TERMİNAL	300		1,175
065 100 140002	TSF-1-D MINI 4,8 FASTON TİP TERMİNAL	500		0,899
065 100 140004	TSF-1-E FASTON TİP TERMİNAL	300		1,227



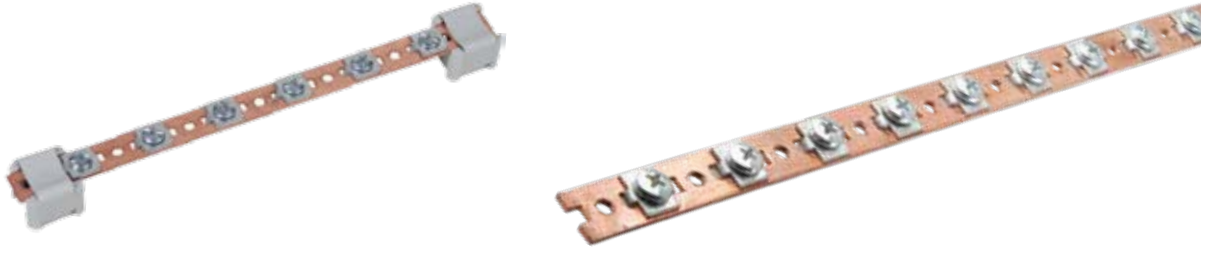

TOPRAKLAMA BARASI VE MESNEDİ

Ürün Kodu	Ürün Adı	Adet	Fiyat (₺)
034 025 040000	TOPRAKLAMA BARASI 1 mm (31 VİDA)	40	544,5
034 025 100001	TOPRAKLAMA BARASI MESNEDİ	100	7,00

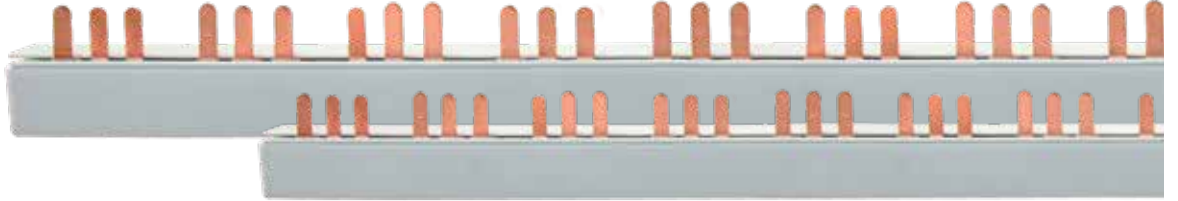

TRİFAZE BARALAR

Ürün Kodu	Ürün Adı	Adet	Fiyat (₺)
034 025 040004	TRİFAZE MÜŞTEREK BARA İĞNE UÇLU 80A - 53 cm	24	438,32
034 025 040005	TRİFAZE MÜŞTEREK BARA İĞNE UÇLU 63A - 53 cm	24	340,31
034 025 040006	TRİFAZE MÜŞTEREK BARA İĞNE UÇLU 80A - 106 cm	24	875,74
034 025 040007	TRİFAZE MÜŞTEREK BARA İĞNE UÇLU 63A - 106 cm	24	680,63



MONOFAZE BARALAR

Ürün Kodu	Ürün Adı	Adet	Fiyat (₺)
034 025 040002	MONOFAZE MÜŞTEREK BARA İĞNE UÇLU 106 cm	50	363
034 025 040003	MONOFAZE MÜŞTEREK BARA İĞNE UÇLU 53 cm	50	189,75

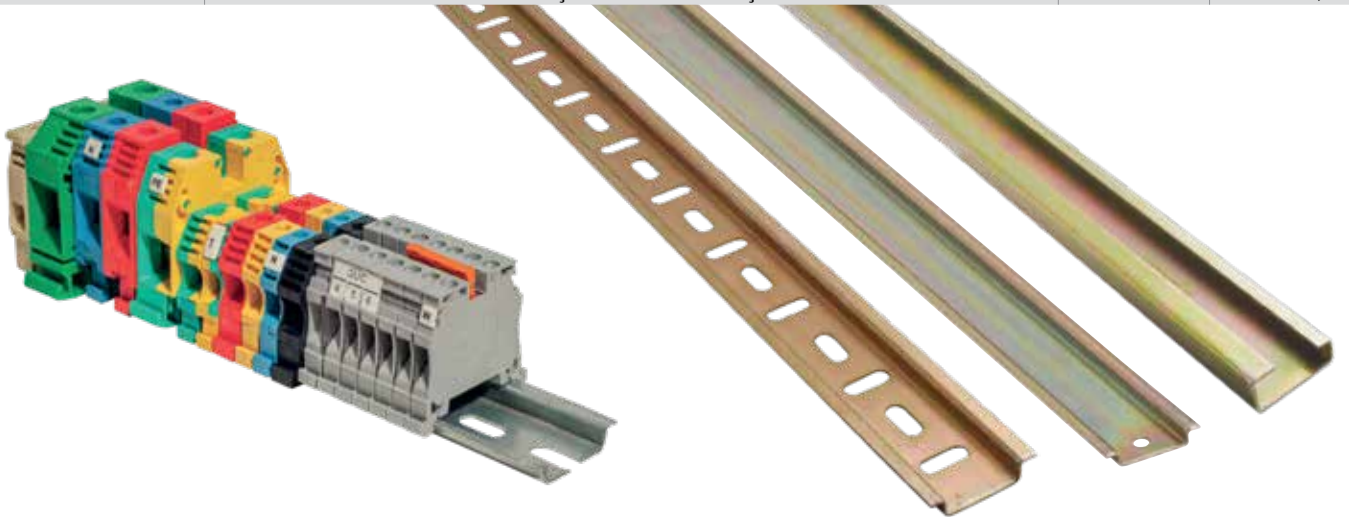

RAYLAR

Ürün Kodu	Ürün Adı	Adet	Fiyat (₺)
001 025 020100 00 00	KLEMENS RAYI(1mt.)	25 mt.	105,98
001 025 000100 00 00	W OTOMAT RAYI(1M) (1mt. Fiyatı)	50 mt.	53,35
001 025 000200 00 00	W OTOMAT RAYI(2M) (1mt. Fiyatı)	50 mt.	53,35
001 025 000033 00 00	W OTOMAT RAYI (33 cm)	50 mt.	18,16
001 025 900100 00 00	W OTOMAT RAYI(DELİKLİ)(1M)(1mt Fiyatı)	50 mt.	58,36
001 025 900200 00 00	W OTOMAT RAYI(DELİKLİ)(2M)(1mt Fiyatı)	50 mt.	58,36

EKO KABLO PABUÇLARI

Ürün Kodu	Ürün Adı	Civata	D3	D2	D1	L	A	Kutu Adet	Fiyat (₺)
123 037 000016	16-06 EKO TİP KABLO PABUCU	M6	6,5	5,8	7,4	30	12	500	7,805
123 037 000025	25-08 EKO TİP KABLO PABUCU	M8	8,5	7	9,2	40	14	350	15,700
123 037 000035	35-08 EKO TİP KABLO PABUCU	M8	8,5	8,2	10,7	44	15,3	200	21,417
123 037 000050	50-10 EKO TİP KABLO PABUCU	M10	10,5	10,2	12,8	52	20	150	26,136
123 037 000070	70-10 EKO TİP KABLO PABUCU	M10	10,5	11,7	14,7	55	22	100	43,832
123 037 000095	95-12 EKO TİP KABLO PABUCU	M12	13	13,6	16,7	59	26	70	50,639
123 037 000120	120-12 EKO TİP KABLO PABUCU	M12	13	15,5	19	70	29	50	69,968
123 037 000150	150-12 EKO TİP KABLO PABUCU	M12	13	16,7	21	77	32	40	114,799
123 037 000185	185-16 EKO TİP KABLO PABUCU	M16	17	18,8	23	85	35	30	132,586
123 037 000240	240-16 EKO TİP KABLO PABUCU	M16	17	21,2	26	90	38,5	24	193,116

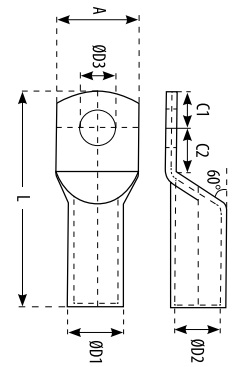

STANDART KABLO PABUÇLARI

Ürün Kodu	Ürün Adı	Civata	D3	D2	D1	L	A	Kutu Adet	Fiyat (₺)
123 037 500010	10-05 STANDART TİP KABLO PABUCU	M5	5,2	4,7	6,5	27,5	10,5	800	8,349
123 037 500011	10-06 STANDART TİP KABLO PABUCU	M6	6,5	4,7	6,5	27,5	10,5	800	8,894
123 037 500012	10-08 STANDART TİP KABLO PABUCU	M8	8,5	4,7	6,5	27,5	10,5	800	9,892
123 037 500016	16-06 STANDART TİP KABLO PABUCU	M6	6,5	5,8	7,4	30	12	500	12,524
123 037 500017	16-08 STANDART TİP KABLO PABUCU	M8	8,5	5,8	7,8	30	12	500	13,613
123 037 500024	25-06 STANDART TİP KABLO PABUCU	M6	6,5	7	9,2	40	14	350	22,960
123 037 500025	25-08 STANDART TİP KABLO PABUCU	M8	8,5	7	9,2	40	14	350	21,417
123 037 500026	25-10 STANDART TİP KABLO PABUCU	M10	10,5	7	9,5	40	14	350	22,960
123 037 500034	35-06 STANDART TİP KABLO PABUCU	M6	6,5	8,2	10,7	44	15,3	200	31,309
123 037 500035	35-08 STANDART TİP KABLO PABUCU	M8	8,5	8,2	10,7	44	15,3	200	29,766
123 037 500036	35-10 STANDART TİP KABLO PABUCU	M10	10,5	8,2	10,7	44	15,3	200	30,855
123 037 500037	35-12 STANDART TİP KABLO PABUCU	M12	13	8,2	10,7	44	15,3	200	32,398
123 037 500049	50-08 STANDART TİP KABLO PABUCU	M8	8,5	10,2	12,8	52	20	150	48,007
123 037 500050	50-10 STANDART TİP KABLO PABUCU	M10	10,5	10,2	12,8	52	20	150	44,377
123 037 500051	50-12 STANDART TİP KABLO PABUCU	M12	13	10,2	12,8	52	20	150	46,464
123 037 500069	70-08 STANDART TİP KABLO PABUCU	M8	8,5	11,7	14,7	55	22	100	63,707
123 037 500070	70-10 STANDART TİP KABLO PABUCU	M10	10,5	11,7	14,7	55	22	100	58,443
123 037 500071	70-12 STANDART TİP KABLO PABUCU	M12	13	11,7	14,7	55	22	100	61,075
123 037 500093	95-08 STANDART TİP KABLO PABUCU	M8	8,5	13,6	16,7	59	26	70	73,054
123 037 500094	95-10 STANDART TİP KABLO PABUCU	M10	10,5	13,6	16,7	59	26	70	68,879
123 037 500095	95-12 STANDART TİP KABLO PABUCU	M12	13	13,6	16,7	59	26	70	68,879
123 037 500119	120-10 STANDART TİP KABLO PABUCU	M10	10,5	15,5	19	70	29	50	101,277
123 037 500120	120-12 STANDART TİP KABLO PABUCU	M12	13	15,5	19	70	29	50	100,188
123 037 500149	150-10 STANDART TİP KABLO PABUCU	M10	10,5	16,7	21	77	32	40	158,631
123 037 500150	150-12 STANDART TİP KABLO PABUCU	M12	13	16,7	21	77	32	40	156,544
123 037 500183	185-10 STANDART TİP KABLO PABUCU	M10	10,5	18,8	23	85	35	30	185,765
123 037 500184	185-12 STANDART TİP KABLO PABUCU	M12	13	18,8	23	85	35	30	184,767
123 037 500185	185-16 STANDART TİP KABLO PABUCU	M16	17	18,8	23	85	35	30	182,680
123 037 500238	240-10 STANDART TİP KABLO PABUCU	M10	10,5	21,2	26	90	38,5	24	260,906
123 037 500239	240-12 STANDART TİP KABLO PABUCU	M12	13	21,2	26	90	38,5	24	252,557
123 037 500240	240-16 STANDART TİP KABLO PABUCU	M16	17	21,2	26	90	38,5	24	252,557
123 037 500299	300-12 STANDART TİP KABLO PABUCU	M12	13	23,5	28,6	100	43	20	313,088
123 037 500300	300-16 STANDART TİP KABLO PABUCU	M16	17	23,5	28,6	100	43	20	313,088



BORU TİP SIKMALI EK MUFLAR

Ürün Kodu	Ürün Adı	D2	D3	L	Kutu Adet	Fiyat (₺)
123 037 300016	16 mm² BORU TİP SIKMALI EK MUF	5,8	7,4	30	500	8,894
123 037 300025	25 mm² BORU TİP SIKMALI EK MUF	7,2	9,2	40	300	16,698
123 037 300035	35 mm² BORU TİP SIKMALI EK MUF	8,5	11	44	200	21,962
123 037 300050	50 mm² BORU TİP SIKMALI EK MUF	10	13	52	150	28,223
123 037 300070	70 mm² BORU TİP SIKMALI EK MUF	11,5	14,7	55	100	47,009
123 037 300095	95 mm² BORU TİP SIKMALI EK MUF	13,5	16,7	59	70	54,269
123 037 300120	120 mm² BORU TİP SIKMALI EK MUF	15,6	19	70	50	78,317
123 037 300150	150 mm² BORU TİP SIKMALI EK MUF	17	21	77	40	117,975
123 037 300185	185 mm² BORU TİP SIKMALI EK MUF	19	23	85	30	146,108
123 037 300240	240 mm² BORU TİP SIKMALI EK MUF	21	26	90	24	208,725



MUTLUSAN SANAYİ TİPİ FİŞ - PRİZ GRUBU (MONOFAZE 1x16A)



ÜRÜN KODU	010 083 300027
ÜRÜN ADI	MUT-27 1x16 A MONO. TOP. ERKEK FİŞ (EĞİK)
ADET/KOLİ	40/320
FİYAT (₺)	35,24



ÜRÜN KODU	010 083 300028
ÜRÜN ADI	MUT-28 1x16 A MONO. TOP. ERKEK FİŞ (DÜZ)
ADET/KOLİ	40/320
FİYAT (₺)	35,24



ÜRÜN KODU	010 083 300029
ÜRÜN ADI	MUT-29 1x16 A MONO. TOP. DİŞİ FİŞ
ADET/KOLİ	25/200
FİYAT (₺)	61,44



ÜRÜN KODU	010 083 500296
ÜRÜN ADI	MUT-29/6 1x16 A MONO. TOP. DUVAR PRİZ
ADET/KOLİ	20/150
FİYAT (₺)	77,26



ÜRÜN KODU	010 083 500293
ÜRÜN ADI	MUT-29/3 1x16 A MONO. 3'LÜ GRUP PRİZ
ADET/KOLİ	12/96
FİYAT (₺)	125,14



ÜRÜN KODU	010 083 500294
ÜRÜN ADI	MUT-29/4 1x16 A MONO. 4'LÜ GRUP PRİZ
ADET/KOLİ	10/80
FİYAT (₺)	158,13



ÜRÜN KODU	010 083 501292
ÜRÜN ADI	MUT-29/2A 1x16 A MONO. 2'Lİ GRUP PRİZ ANAHTARLI
ADET/KOLİ	12/96
FİYAT (₺)	221,38



ÜRÜN KODU	010 083 501293
ÜRÜN ADI	MUT-29/3A 1x16 A MONO. 3'LÜ GRUP PRİZ ANAHTARLI
ADET/KOLİ	10/80
FİYAT (₺)	265,59



ÜRÜN KODU	010 083 500292
ÜRÜN ADI	MUT-29/2 1x16 A MONO. 2'Lİ GRUP PRİZ
ADET/KOLİ	14/112
FİYAT (₺)	96,68

MUTLUSAN SANAYİ TİPİ FİŞ - PRİZ GRUBU (TRİFAZE 3x25A)



ÜRÜN KODU	010 083 400030
ÜRÜN ADI	MUT-30 3x25 A TRİFAZE ERKEK FİŞ
ADET/KOLİ	25/200
FİYAT (₺)	77,26



ÜRÜN KODU	010 083 400031
ÜRÜN ADI	MUT-31 3x25 A TRİFAZE DİŞİ İŞ (SEYYAR)
ADET/KOLİ	20/160
FİYAT (₺)	121,98



ÜRÜN KODU	010 083 600315
ÜRÜN ADI	MUT-31/5 3x25 A TRİFAZE DUVAR PRİZİ
ADET/KOLİ	20/160
FİYAT (₺)	148,27



ÜRÜN KODU	010 083 600311
ÜRÜN ADI	MUT-31/1 1 TRİFAZE + 1 MONOFAZE GR. PRİZ
ADET/KOLİ	10/80
FİYAT (₺)	267,42



ÜRÜN KODU	010 083 600312
ÜRÜN ADI	MUT-31/2 TRİFAZE GRUP PRİZ -2'Lİ
ADET/KOLİ	10/80
FİYAT (₺)	301,46



ÜRÜN KODU	010 083 600313
ÜRÜN ADI	MUT-31/3 TRİFAZE GRUP PRİZ -3'LÜ
ADET/KOLİ	10/80
FİYAT (₺)	340,12



ÜRÜN KODU	010 083 600316
ÜRÜN ADI	MUT-31/6 2 TRİFAZE + 1 MONOFAZE GR. PRİZ
ADET/KOLİ	10/80
FİYAT (₺)	340,12



ÜRÜN KODU	010 083 600317
ÜRÜN ADI	MUT-31/7 1 TRİFAZE + 2 MONOFAZE GR. PRİZ
ADET/KOLİ	10/80
FİYAT (₺)	340,12

MUTLUSAN SANAYİ TİPİ FİŞ - PRİZ GRUBU (TRİFAZE 3x16A)

CE



ÜRÜN KODU	010 083 400060
ÜRÜN ADI	MUT-60 3x16 A TRİFAZE ERKEK FİŞ
ADET/KOLİ	30/240
FİYAT (₺)	140,6

CE



ÜRÜN KODU	010 083 400061
ÜRÜN ADI	MUT-61 3x16 A TRİFAZE SEYYAR DIŞI FİŞ
ADET/KOLİ	25/200
FİYAT (₺)	170,05

CE



ÜRÜN KODU	010 083 400062
ÜRÜN ADI	MUT-62 3x16 A TRİFAZE DUVAR PRİZİ
ADET/KOLİ	20/160
FİYAT (₺)	214,98

MUTLUSAN SANAYİ TİPİ FİŞ - PRİZ GRUBU (TRİFAZE 3x32A)

CE



ÜRÜN KODU	010 083 400070
ÜRÜN ADI	MUT-70 3x32 A TRİFAZE ERKEK FİŞ
ADET/KOLİ	20/160
FİYAT (₺)	201,28

CE



ÜRÜN KODU	010 083 400071
ÜRÜN ADI	MUT-71 3x32 A TRİFAZE SEYYAR DIŞI FİŞ
ADET/KOLİ	15/120
FİYAT (₺)	228,67

CE



ÜRÜN KODU	010 083 400072
ÜRÜN ADI	MUT-72 3x32 A TRİFAZE DUVAR PRİZİ
ADET/KOLİ	20/160
FİYAT (₺)	301,93



MUTLUSAN CEE NORM SANAYİ TİPİ FİŞ - PRİZ GRUBU



CEE	ÜRÜN KODU	010 083 000316
	ÜRÜN ADI	MUT-301 CEE NORM 3/16 A DÜZ FİŞ (YENİ ÜRÜN)
	ADET/KOLİ	16/128
	FİYAT (₺)	140,96



CEE	ÜRÜN KODU	010 083 010316
	ÜRÜN ADI	MUT-302 CEE NORM 3/16 UZATMA PRİZ (YENİ ÜRÜN)
	ADET/KOLİ	15/120
	FİYAT (₺)	180,71



CEE	ÜRÜN KODU	010 083 020316
	ÜRÜN ADI	MUT-303 CEE NORM 3/16 MAKİNE PRİZİ (YENİ ÜRÜN)
	ADET/KOLİ	20/160
	FİYAT (₺)	176,2



CEE	ÜRÜN KODU	010 083 030316
	ÜRÜN ADI	MUT-304 CEE NORM 3/16 DUVAR PRİZİ (YENİ ÜRÜN)
	ADET/KOLİ	8/64
	FİYAT (₺)	230,41



CEE	ÜRÜN KODU	010 083 000416
	ÜRÜN ADI	MUT-401 CEE NORM 4/16 A DÜZ FİŞ (YENİ ÜRÜN)
	ADET/KOLİ	16/128
	FİYAT (₺)	148,1



CEE	ÜRÜN KODU	010 083 010416
	ÜRÜN ADI	MUT-402 CEE NORM 4/16 A UZATMA PRİZİ (YENİ ÜRÜN)
	ADET/KOLİ	15/120
	FİYAT (₺)	190,2



CEE	ÜRÜN KODU	010 083 020416
	ÜRÜN ADI	MUT-403 CEE NORM 4/16 A MAKİNE PRİZİ (YENİ ÜRÜN)
	ADET/KOLİ	20/160
	FİYAT (₺)	186,59



CEE	ÜRÜN KODU	010 083 030416
	ÜRÜN ADI	MUT-404 CEE NORM 4/16 A DUVAR PRİZİ (YENİ ÜRÜN)
	ADET/KOLİ	8/64
	FİYAT (₺)	246,31



CEE	ÜRÜN KODU	010 083 000516
	ÜRÜN ADI	MUT-101 CEE NORM 5x16 A DÜZ FİŞ
	ADET/KOLİ	16/128
	FİYAT (₺)	170,32



CEE	ÜRÜN KODU	010 083 020516
	ÜRÜN ADI	MUT-103 CEE NORM 5x16 A MAKİNE PRİZİ
	ADET/KOLİ	20/160
	FİYAT (₺)	214,6



CEE	ÜRÜN KODU	010 083 010516
	ÜRÜN ADI	MUT-102 CEE NORM 5x16 A UZATMA PRİZİ
	ADET/KOLİ	15/120
	FİYAT (₺)	218,66



CEE	ÜRÜN KODU	010 083 030516
	ÜRÜN ADI	MUT-104 CEE NORM 5x16 A DUVAR PRİZİ
	ADET/KOLİ	8/64
	FİYAT (₺)	283,27



CE	ÜRÜN KODU	010 083 000332
	ÜRÜN ADI	MUT-310 CEE NORM 3/32 A DÜZ FİŞ (YENİ ÜRÜN)
	ADET/KOLİ	12/112
	FİYAT (₺)	194,27



CE	ÜRÜN KODU	010 083 010332
	ÜRÜN ADI	MUT-320 CEE NORM 3/32 UZATMA PRİZ (YENİ ÜRÜN)
	ADET/KOLİ	12/96
	FİYAT (₺)	230,41



CE	ÜRÜN KODU	010 083 020332
	ÜRÜN ADI	MUT-330 CEE NORM 3/32 MAKİNE PRİZİ (YENİ ÜRÜN)
	ADET/KOLİ	14/112
	FİYAT (₺)	198,79



CE	ÜRÜN KODU	010 083 030332
	ÜRÜN ADI	MUT-340 CEE NORM 3/32 DUVAR PRİZİ (YENİ ÜRÜN)
	ADET/KOLİ	8/64
	FİYAT (₺)	253



CE	ÜRÜN KODU	
	ÜRÜN ADI	MUT-410 CEE NORM 4/32 A DÜZ FİŞ (YENİ ÜRÜN)
	ADET/KOLİ	14/112
	FİYAT (₺)	205,34



CE	ÜRÜN KODU	010 083 010432
	ÜRÜN ADI	MUT-420 CEE NORM 4/32 A UZATMA PRİZİ (YENİ ÜRÜN)
	ADET/KOLİ	12/96
	FİYAT (₺)	246,4



CE	ÜRÜN KODU	010 083 020432
	ÜRÜN ADI	MUT-430 CEE NORM 4/32 A MAKİNE PRİZİ (YENİ ÜRÜN)
	ADET/KOLİ	14/112
	FİYAT (₺)	210,31



CE	ÜRÜN KODU	010 083 030432
	ÜRÜN ADI	MUT-440 CEE NORM 4/32 A DUVAR PRİZİ (YENİ ÜRÜN)
	ADET/KOLİ	8/64
	FİYAT (₺)	268,81



CE	ÜRÜN KODU	010 083 000532
	ÜRÜN ADI	MUT-201 CEE NÖRM 5x32 A DÜZ FİŞ
	ADET/KOLİ	14/112
	FİYAT (₺)	225,89



CE	ÜRÜN KODU	010 083 020532
	ÜRÜN ADI	MUT-203 CEE NÖRM 5x32 A MAKİNE PRİZİ
	ADET/KOLİ	14/112
	FİYAT (₺)	231,31



CE	ÜRÜN KODU	010 083 010532
	ÜRÜN ADI	MUT-202 CEE NÖRM 5x32 A UZATMA PRİZİ
	ADET/KOLİ	12/96
	FİYAT (₺)	271,07



CE	ÜRÜN KODU	010 083 030532
	ÜRÜN ADI	MUT-204 CEE NÖRM 5x32 A DUVAR PRİZİ
	ADET/KOLİ	8/64
	FİYAT (₺)	295,47

MUTLUSAN SANAYİ TİPİ FİŞ - PRİZ GRUBU (MONOFAZE 1x16A)



CE

ÜRÜN KODU	010 083 500298
ÜRÜN ADI	MUT-29/8 MONOFAZE TOP. PANO PRİZİ
ADET/KOLİ	40/320
FİYAT (₺)	42,02



CE

ÜRÜN KODU	010 083 500297
ÜRÜN ADI	MUT-29/7 MONOFAZE DUVAR PRİZİ (PLS.)
ADET/KOLİ	30/240
FİYAT (₺)	67,77



CE

ÜRÜN KODU	010 083 500299
ÜRÜN ADI	MUT-29/9 MONOFAZE MAKİNE PRİZİ
ADET/KOLİ	20/160
FİYAT (₺)	85,39



CE

ÜRÜN KODU	010 083 502910
ÜRÜN ADI	MUT-29/10 MONOFAZE DUVAR PRİZİ
ADET/KOLİ	15/120
FİYAT (₺)	113,4

MUTLUSAN SANAYİ TİPİ FİŞ - PRİZ GRUBU (TRİFAZE 3x16A)



CE

ÜRÜN KODU	010 083 400064
ÜRÜN ADI	MUT-64 3x16 TRİFAZE MAKİNE PRİZİ (PLS.)
ADET/KOLİ	20/160
FİYAT (₺)	141,07



CE

ÜRÜN KODU	010 083 400063
ÜRÜN ADI	MUT-63 3x16 TRİFAZE DUVAR PRİZİ (PLS.)
ADET/KOLİ	12/96
FİYAT (₺)	157,58

MUTLUSAN SANAYİ TİPİ FİŞ - PRİZ GRUBU (TRİFAZE 3x25A)



CE

ÜRÜN KODU	010 083 400318
ÜRÜN ADI	MUT-31/8 3x25 TRİFAZE MAKİNE PRİZİ (PLS.)
ADET/KOLİ	20/160
FİYAT (₺)	113,4



CE

ÜRÜN KODU	010 083 400319
ÜRÜN ADI	MUT-31/9 3x25 TRİFAZE DUVAR PRİZİ (PLS.)
ADET/KOLİ	15/120
FİYAT (₺)	149,63

MUTLUSAN SANAYİ TİPİ FİŞ - PRİZ GRUBU (TRİFAZE 3x32A)



CE

ÜRÜN KODU	010 083 400074
ÜRÜN ADI	MUT-74 3x32 TRİFAZE MAKİNE PRİZİ (PLS.)
ADET/KOLİ	20/160
FİYAT (₺)	171,27



CE

ÜRÜN KODU	010 083 400073
ÜRÜN ADI	MUT-73 3x32 TRİFAZE DUVAR PRİZİ (PLS.)
ADET/KOLİ	12/96
FİYAT (₺)	201,28

SİNTAŞ SANAYİ TİPİ FİŞ - PRİZLER

Ürün Kodu	Ürün Adı	Kutu Adet	Koli Adet	Fiyat (₺)
019 107 016250	16X25 A.4 KUTUPLU FİŞ-PRİZ	1	30	603,95
019 107 016252	16X25 A.4 KUTUPLU PRİZ	1	45	320,95
019 107 016251	16X25 A.4 KUTUPLU FİŞ	1	60	259,42
019 107 025400	25x40 A.4 KUTUPLU FİŞ-PRİZ	1	15	793,16
019 107 025402	25x40 A.4 KUTUPLU PRİZ	1	25	414,74
019 107 025401	25x40 A.4 KUTUPLU FİŞ	1	35	378,42
019 107 040630	40X63 A.4 KUTUPLU FİŞ-PRİZ	1	10	1.046,34
019 107 040632	40X63 A.4 KUTUPLU PRİZ	1	15	551,36
019 107 040631	40X63 A.4 KUTUPLU FİŞ	1	25	494,98
019 107 063100	63X100 A.4 KUTUPLU FİŞ-PRİZ	1	5	1.639,44
019 107 063102	63X100 A.4 KUTUPLU PRİZ	1	10	879,9
019 107 063101	63X100 A.4 KUTUPLU FİŞ	1	15	759,54



SİNTAŞ SANAYİ TİPİ SEYYAR PRİZLER

Ürün Kodu	Ürün Adı	Kutu Adet	Koli Adet	Fiyat (₺)
019 107 016253	16X25 A.4 KUTUPLU SEYYAR PRİZ	1	45	320,95
019 107 025403	25x40 A.4 KUTUPLU SEYYAR PRİZ	1	25	414,74
019 107 040633	40X63 A.4 KUTUPLU SEYYAR PRİZ	1	15	551,36
019 107 063103	63X100 A.4 KUTUPLU SEYYAR PRİZ	1	10	879,9

KABLO MAKARASI

Ürün Kodu	Ürün Adı	Kutu Adet	Koli Adet	Fiyat
005 083 700045	MONOFAZE PLS. BOŞ MAKARA 50 mt. KAPASİTELİ (4 MONOFAZE PRİZLİ)	1	1	23,01 \$



TERMOPLASTİK BUATLAR VE KOMBİNASYON KUTULARI

IP65

ÜRÜN KODU	001 046 000101 00 00
ÜRÜN ADI	85x85 KARE ANTİGRON BUAT
ADET/KOLİ	10/300
FİYAT (₺)	30,35



IP65

ÜRÜN KODU	001 046 071827 00 17
ÜRÜN ADI	180x270x100 (14 ÇIKIŞ) TERMOPLASTİK BUAT
ADET/KOLİ	2/8
FİYAT (₺)	247,15



IP65

ÜRÜN KODU	001 046 076131 00 17
ÜRÜN ADI	138x226x131 TERMOPLASTİK BUAT
ADET/KOLİ	1/8
FİYAT (₺)	238,85



IP40

ÜRÜN KODU	001 046 078080 00 17
ÜRÜN ADI	80x80x48 (7 ÇIKIŞLI) TERMOPLASTİK BUAT
ADET/KOLİ	18/108
FİYAT (₺)	29,61



IP65

ÜRÜN KODU	001 046 078226 00 17
ÜRÜN ADI	138x226x127 KOMBİNASYON KUTUSU
ADET/KOLİ	1/8
FİYAT (₺)	250,66



IP65

ÜRÜN KODU	001 046 072698 00 44
ÜRÜN ADI	138x226x98 (ŞEFFAF) TERMOPLASTİK BUAT
ADET/KOLİ	1/8
FİYAT (₺)	238,79



IP40

ÜRÜN KODU	001 046 078585 00 17
ÜRÜN ADI	85x85x48 TERMOPLASTİK BUAT
ADET/KOLİ	18/108
FİYAT (₺)	27,88



IP65

ÜRÜN KODU	001 046 075311 00 17
ÜRÜN ADI	225x311x132 KOMBİNASYON KUTUSU
ADET/KOLİ	1/4
FİYAT (₺)	401,81



IP65

ÜRÜN KODU	001 046 076131 00 44
ÜRÜN ADI	138x226x131 (ŞEFFAF) TERMOPLASTİK BUAT
ADET/KOLİ	1/8
FİYAT (₺)	254,1



IP40

ÜRÜN KODU	001 046 070090 00 17
ÜRÜN ADI	Ø90 TERMOPLASTİK BUAT
ADET/KOLİ	18/108
FİYAT (₺)	49,1



IP65

ÜRÜN KODU	001 046 071199 00 17
ÜRÜN ADI	225x311x99 TERMOPLASTİK BUAT
ADET/KOLİ	1/4
FİYAT (₺)	300,98



IP65

ÜRÜN KODU	001 046 071199 00 44
ÜRÜN ADI	225x311x99 (ŞEFFAF) TERMOPLASTİK BUAT
ADET/KOLİ	1/4
FİYAT (₺)	404,07



IP65

ÜRÜN KODU	001 046 071010 00 17
ÜRÜN ADI	110x110x74 (8 ÇIKIŞ) TERMOPLASTİK BUAT
ADET/KOLİ	10/40
FİYAT (₺)	72,03



IP65

ÜRÜN KODU	001 046 071130 00 17
ÜRÜN ADI	225x311x130 TERMOPLASTİK BUAT
ADET/KOLİ	1/4
FİYAT (₺)	320,52



IP65

ÜRÜN KODU	001 046 071130 00 44
ÜRÜN ADI	225x311x130 (ŞEFFAF) TERMOPLASTİK BUAT
ADET/KOLİ	1/4
FİYAT (₺)	433,46



IP65

ÜRÜN KODU	001 046 071118 00 17
ÜRÜN ADI	110x180x77 (10 ÇIKIŞ) TERMOPL. BUAT
ADET/KOLİ	5/30
FİYAT (₺)	106,22



IP65

ÜRÜN KODU	001 046 072698 00 17
ÜRÜN ADI	138x226x98 TERMOPLASTİK BUAT
ADET/KOLİ	1/8
FİYAT (₺)	198,91



ALEV YAYMAYAN TERMOPLASTİK BUATLAR VE KOMBİNASYON KUTULARI



IP40

ÜRÜN KODU	001 046 098080 00 17
ÜRÜN ADI	80x80x48 (7 ÇIKIŞLI) TERMOPLASTİK BUAT - A.YAYMAYAN
ADET/KOLİ	18/108
FİYAT (₺)	52,54



IP65

ÜRÜN KODU	001 046 098226 00 17
ÜRÜN ADI	138x226x127 KOMBİNASYON KUTUSU - A.YAYMAYAN
ADET/KOLİ	1/8
FİYAT (₺)	377,49



IP65

ÜRÜN KODU	001 046 092698 00 44
ÜRÜN ADI	138x226x98 (ŞEFFAF) TERMOPLASTİK BUAT - A.YAYMAYAN
ADET/KOLİ	1/8
FİYAT (₺)	284,7



IP40

ÜRÜN KODU	001 046 098585 00 17
ÜRÜN ADI	85x85x48 TERMOPLASTİK BUAT - A.YAYMAYAN
ADET/KOLİ	18/108
FİYAT (₺)	62,99



IP65

ÜRÜN KODU	001 046 095311 00 17
ÜRÜN ADI	225x311x132 KOMBİNASYON KUTUSU - A.YAYMAYAN
ADET/KOLİ	1/4
FİYAT (₺)	607,7



IP65

ÜRÜN KODU	001 046 096131 00 44
ÜRÜN ADI	138x226x131 (ŞEFFAF) TERMOPLASTİK BUAT - A.YAYMAYAN
ADET/KOLİ	1/8
FİYAT (₺)	308,98



IP40

ÜRÜN KODU	001 046 090090 00 17
ÜRÜN ADI	Ø90 TERMOPLASTİK BUAT - A.YAYMAYAN
ADET/KOLİ	18/108
FİYAT (₺)	53,4



IP65

ÜRÜN KODU	001 046 091199 00 17
ÜRÜN ADI	225x311x99 TERMOPLASTİK BUAT - A.YAYMAYAN
ADET/KOLİ	1/4
FİYAT (₺)	502,69



IP65

ÜRÜN KODU	001 046 091199 00 44
ÜRÜN ADI	225x311x99 (ŞEFFAF) TERMOPLASTİK BUAT - A.YAYMAYAN
ADET/KOLİ	1/4
FİYAT (₺)	481,31



IP65

ÜRÜN KODU	001 046 091010 00 17
ÜRÜN ADI	110x110x74 (8 ÇIKIŞ) TERMOPLASTİK BUAT - A.YAYMAYAN
ADET/KOLİ	10/40
FİYAT (₺)	143,88



IP65

ÜRÜN KODU	001 046 091130 00 17
ÜRÜN ADI	225x311x130 TERMOPLASTİK BUAT - A.YAYMAYAN
ADET/KOLİ	1/4
FİYAT (₺)	554,68



IP65

ÜRÜN KODU	001 046 091130 00 44
ÜRÜN ADI	225x311x130 (ŞEFFAF) TERMOPLASTİK BUAT - A.YAYMAYAN
ADET/KOLİ	1/4
FİYAT (₺)	509,86



IP65

ÜRÜN KODU	001 046 091118 00 17
ÜRÜN ADI	110x180x77 (10 ÇIKIŞ) TERMOPLS. BUAT - A.YAYMAYAN
ADET/KOLİ	5/30
FİYAT (₺)	246,65



IP65

ÜRÜN KODU	001 046 092698 00 17
ÜRÜN ADI	138x226x98 TERMOPLASTİK BUAT - A.YAYMAYAN
ADET/KOLİ	1/8
FİYAT (₺)	297,06



IP65

ÜRÜN KODU	001 046 091827 00 17
ÜRÜN ADI	180x270x100 (14 ÇIKIŞ) TERMOPLS. BUAT A.YAYMAYAN
ADET/KOLİ	2/8
FİYAT	550,13



IP65

ÜRÜN KODU	001 046 096131 00 17
ÜRÜN ADI	138x226x131 TERMOPLASTİK BUAT - A.YAYMAYAN
ADET/KOLİ	1/8
FİYAT	341,76



KOMBİNASYON PANOLARI



ÜRÜN KODU	010 104 000180
ÜRÜN ADI	MK-325-2 3x25 A 1 ADET ÖN+ 1x16 A 2 ADET YAN
ADET/KOLİ	4
FİYAT (₺)	542,14



ÜRÜN KODU	010 104 000181
ÜRÜN ADI	MK-516-1 5x16 A 1 ADET ÖN+ 1x16 A 1 ADET YAN
ADET/KOLİ	6
FİYAT (₺)	384,02



ÜRÜN KODU	010 104 000182
ÜRÜN ADI	MK-516-2 5x16 A 1 ADET ÖN+ 1x16 A 2 ADET YAN
ADET/KOLİ	4
FİYAT (₺)	625,72



ÜRÜN KODU	010 104 000183
ÜRÜN ADI	MK-532-1 5x32 A 1 ADET ÖN+ 1x16 A 1 ADET YAN
ADET/KOLİ	6
FİYAT (₺)	417,9



ÜRÜN KODU	010 104 000184
ÜRÜN ADI	MK-532-2 5x32 A 1 ADET ÖN+ 1x16 A 2 ADET YAN
ADET/KOLİ	4
FİYAT (₺)	684,46



ÜRÜN KODU	010 104 000185
ÜRÜN ADI	MK-2325-2 3x25 A 2 ADET ÖN+ 1x16 A 2 ADET YAN
ADET/KOLİ	4
FİYAT (₺)	740,93



ÜRÜN KODU	010 104 000186
ÜRÜN ADI	MK-2516-2 5x16A 2 ADET ÖN+ 1x16 A 2 ADET YAN
ADET/KOLİ	4
FİYAT (₺)	928,42



ÜRÜN KODU	010 104 000187
ÜRÜN ADI	MK-2516-4 5x16 A 2 ADET ÖN+ 1x16 A 4 ADET YAN
ADET/KOLİ	4
FİYAT (₺)	1.016,52



ÜRÜN KODU	010 104 000188
ÜRÜN ADI	MK-2532-2 5x32 A 2 ADET ÖN+ 1x16 A 2 ADET YAN
ADET/KOLİ	4
FİYAT (₺)	1.084,29



ÜRÜN KODU	010 104 000189
ÜRÜN ADI	MK-2532-4 5x32 A 2 ADET ÖN+ 1x16 A 4 ADET YAN
ADET/KOLİ	4
FİYAT (₺)	1.167,87



ÜRÜN KODU	010 104 000190
ÜRÜN ADI	MK-5164-4 5x16A 4 ADET ÖN+ 1x16 A 4 ADET YAN
ADET/KOLİ	3
FİYAT (₺)	1.513,48



ÜRÜN KODU	010 104 000191
ÜRÜN ADI	MK-5324-4 5x32 A 4 ADET ÖN+ 1x16 A 4 ADET YAN
ADET/KOLİ	3
FİYAT (₺)	1.721,3

KOMBİNASYON KUTULARI



ÜRÜN KODU	010 104 000192
ÜRÜN ADI	MK-51632-4 5x16A 2 ADET ÖN+5x32 A 2 AD. ÖN+ 1x16 A 4 ADET YAN
ADET/KOLİ	3
FİYAT (₺)	1.671,61



ÜRÜN KODU	001 046 075130 00 17
ÜRÜN ADI	1'Lİ KOMBİNASYON KUTUSU BOŞ 215x130 GRİ
ADET/KOLİ	1/10
FİYAT (₺)	261,98



ÜRÜN KODU	001 046 070220 00 17
ÜRÜN ADI	2'Lİ KOMBİNASYON KUTUSU BOŞ 290x220 GRİ
ADET/KOLİ	1/4
FİYAT (₺)	495,39

KORUMA PANOLARI (YENİ ÜRÜN)



ÜRÜN KODU	010 104 000207
ÜRÜN ADI	GNDMOB16 16A MONOAZE MOBİL NÖTR TOPRAK REGÜLATÖRÜ
ADET/KOLİ	1
FİYAT (₺)	6.325,00



ÜRÜN KODU	010 104 000208
ÜRÜN ADI	GNDMOB32 32A MONOAZE MOBİL NÖTR TOPRAK REGÜLATÖRÜ
ADET/KOLİ	1
FİYAT (₺)	6.776,79



ÜRÜN KODU	010 104 000209
ÜRÜN ADI	GNDMOB3 32A TRİFAZE MOBİL NÖTR TOPRAK REGÜLATÖRÜ
ADET/KOLİ	1
FİYAT (₺)	11.204,29



ÜRÜN KODU	010 104 000210
ÜRÜN ADI	GNDKOM KOMBİ NÖTR TOPRAK REGÜLATÖRÜ
ADET/KOLİ	1
FİYAT (₺)	4.517,86



ÜRÜN KODU	010 104 000211
ÜRÜN ADI	YMMUT3 MAKİNE KORUMA PANOSU
ADET/KOLİ	1
FİYAT (₺)	9.035,71

KUTU MONTAJLI ÜRÜNLER



ÜRÜN KODU	010 104 000120
ÜRÜN ADI	MS-KK31 1'LI KUTULU START BUTONU (1NO)
ADET/KOLİ	18
FİYAT (₺)	112,95



ÜRÜN KODU	010 104 000121
ÜRÜN ADI	MS-KK42 1'LI KUTULU STOP BUTONU (1NC)
ADET/KOLİ	18
FİYAT (₺)	112,95



ÜRÜN KODU	010 104 000122
ÜRÜN ADI	MS-KK51 1'LI KUTULU START BUTONU (1NO)
ADET/KOLİ	18
FİYAT (₺)	112,95



ÜRÜN KODU	010 104 000123
ÜRÜN ADI	MS-BX71 1'LI KUTULU ALARM BUTONU (1NO)
ADET/KOLİ	18
FİYAT (₺)	117,92



ÜRÜN KODU	010 104 000124
ÜRÜN ADI	MS-BX81 1'LI KUTULU AYDINLATMA BUTONU (1NO)
ADET/KOLİ	18
FİYAT (₺)	117,92



ÜRÜN KODU	010 104 000125
ÜRÜN ADI	MS-KK7325 1'LI KUTULU İKİZ STOP BUTONU (1NO+1NC)
ADET/KOLİ	18
FİYAT (₺)	160,38



ÜRÜN KODU	010 104 000126
ÜRÜN ADI	MS-KK4151 1'LI KUTULU İŞARETLİ İKİZ BUTONU (1NO+1NO)
ADET/KOLİ	18
FİYAT (₺)	164,9



ÜRÜN KODU	010 104 000127
ÜRÜN ADI	MS-KBZ 1'LI KUTULU KABİN ALTI İKAZ LAMBASI BUZZERLİ
ADET/KOLİ	18
FİYAT (₺)	211,87



ÜRÜN KODU	010 090 050009
ÜRÜN ADI	MS-BX542 1'LI KUTULU ACİL STOP BUTONU (1NC)
ADET/KOLİ	18
FİYAT (₺)	135,54



ÜRÜN KODU	010 104 000129
ÜRÜN ADI	MS-BX542E 1'LI KUTULU EMERGENCY STOP BUTONU (1NC)
ADET/KOLİ	18
FİYAT (₺)	140,05



ÜRÜN KODU	010 104 000130
ÜRÜN ADI	MS-BX542ASP 1'LI KUT. MÜHÜRLÜ TİP KOR. ACİL STOP BUTONU (1NC)
ADET/KOLİ	12
FİYAT (₺)	249,04



ÜRÜN KODU	010 104 000131
ÜRÜN ADI	MS-BYP3K 1'LI KUTULU 3 KADEME BY-PASS ANAHTARI
ADET/KOLİ	12
FİYAT (₺)	442,75



ÜRÜN KODU	010 104 000132
ÜRÜN ADI	MS-BYK4K 1'LI KUTULU 4 KADEME BY-PASS ANAHTARLI
ADET/KOLİ	12
FİYAT (₺)	493,35



ÜRÜN KODU	010 104 000133
ÜRÜN ADI	MS-KANT 1'LI KUTULU KAYICI RESET ANAHTARI
ADET/KOLİ	12
FİYAT (₺)	194,26

EKO SERİSİ KUMANDA KUTULARI



ÜRÜN KODU	010 104 000105
ÜRÜN ADI	EKO101S EKO 1'LI BOŞ KUMANDA KUTUSU
ADET/KOLİ	90
FİYAT (₺)	34,67



ÜRÜN KODU	010 104 000106
ÜRÜN ADI	EKO201S EKO 1'LI KORUMALI BOŞ KUMANDA KUTUSU
ADET/KOLİ	50
FİYAT (₺)	37,73



ÜRÜN KODU	010 104 000107
ÜRÜN ADI	EKO301S EKO 1'LI ACİL STOP ETİ. KOR.YAZILI KUMANDA KUTUSU
ADET/KOLİ	50
FİYAT (₺)	113,4



ÜRÜN KODU	010 104 000156
ÜRÜN ADI	EKO401S EKO 1'LI ACİL STOPLU KUMANDA KUTUSU
ADET/KOLİ	50
FİYAT (₺)	108,88

BOŞ KUMANDA KUTULARI



ÜRÜN KODU	010 091 010001
ÜRÜN ADI	1'LI ETANJ BUTON KUTUSU EUROBOX
ADET/KOLİ	24
FİYAT (₺)	62,06



ÜRÜN KODU	010 091 010002
ÜRÜN ADI	2'LI ETANJ BUTON KUTUSU EUROBOX
ADET/KOLİ	18
FİYAT (₺)	76,8



ÜRÜN KODU	010 091 010003
ÜRÜN ADI	3'LÜ ETANJ BUTON KUTUSU EUROBOX
ADET/KOLİ	12
FİYAT (₺)	103,01



ÜRÜN KODU	010 091 010004
ÜRÜN ADI	4'LÜ ETANJ BUTON KUTUSU EUROBOX
ADET/KOLİ	10
FİYAT (₺)	119,87

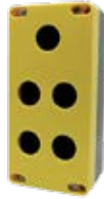

ÜRÜN KODU	010 104 000114
ÜRÜN ADI	SW-BX05SB 5'Lİ ETANJ BUTON KUTUSU EUROBOX
ADET/KOLİ	8
FİYAT (₺)	240,51



ÜRÜN KODU	010 104 000115
ÜRÜN ADI	SW-BX06SB 6'Lİ ETANJ BUTON KUTUSU EUROBOX
ADET/KOLİ	8
FİYAT (₺)	240,51



ÜRÜN KODU	010 104 000116
ÜRÜN ADI	SW-BX07SB 7'Lİ ETANJ BUTON KUTUSU EUROBOX
ADET/KOLİ	6
FİYAT (₺)	240,51



ÜRÜN KODU	010 104 000117
ÜRÜN ADI	SW-BX08SB 8'Lİ ETANJ BUTON KUTUSU EUROBOX
ADET/KOLİ	6
FİYAT (₺)	240,51



ÜRÜN KODU	010 104 000118
ÜRÜN ADI	SW-BX09SB 9'LU ETANJ BUTON KUTUSU EUROBOX
ADET/KOLİ	1
FİYAT (₺)	384,02



ÜRÜN KODU	010 104 000119
ÜRÜN ADI	SW-BX10SB 10'LU ETANJ BUTON KUTUSU EUROBOX
ADET/KOLİ	1
FİYAT (₺)	384,02

ASANSÖR KUYU DİBİ SETLERİ VE KUMANDALARI



ÜRÜN KODU	010 104 000134
ÜRÜN ADI	MS-KYD02 2'Lİ ASANSÖR KUYU DİBİ BUTON 220V 16A TOP. PRİZ+ACİL STOP BUTON
ADET/KOLİ	9
FİYAT (₺)	230,69



ÜRÜN KODU	010 104 000135
ÜRÜN ADI	MS-KYD03 ACİL STOP BUTON + SEÇİCİ BUTON (2NO) 220V 16A TOP. PANO PRİZİ
ADET/KOLİ	6
FİYAT (₺)	350,13



ÜRÜN KODU	010 104 000136
ÜRÜN ADI	MS-KYD04 6'Lİ ACİL STOP BUT.+2 AD. OKLU BUT. (1NO) 1 İKİZ BUT. (2NO) 1 SEÇ.BUT. (2NO)
ADET/KOLİ	5
FİYAT (₺)	573,77



ÜRÜN KODU	010 104 000137
ÜRÜN ADI	MS-KYD05 ACİL STOP BUT.+ 2 OKLU BUT.ORTAK OKLU (1NO) SEÇ.BUT. (2NO-1NC)
ADET/KOLİ	4
FİYAT (₺)	529,87



ÜRÜN KODU	010 104 000138
ÜRÜN ADI	MS-KYD06 ACİL STOP BUT.+ 2 OKLU BUT.(2NO)1 ORTAK BUT.(1NO) ALARM BUT.+SEÇ.BUT. (2NO-1NC)
ADET/KOLİ	2
FİYAT (₺)	573,77



ÜRÜN KODU	010 104 000139
ÜRÜN ADI	KY2-ALR KORUMALI ACİL STOP BUT.(1NC) NO KONTAKLI ALARM BUTONU KOMBİNASYON
ADET/KOLİ	10
FİYAT (₺)	230,41



ÜRÜN KODU	010 104 000140
ÜRÜN ADI	MS-KY5-24 KOR.ACİL STOP BUT.(1NC) LAMB.VAVİEN (1NO)24V KATTA LED (1NO) ALARM BUT. 16A.KAP.PRİZ
ADET/KOLİ	4
FİYAT (₺)	601,29



ÜRÜN KODU	010 104 000141
ÜRÜN ADI	MS-KY3 KOR.ACİL STOP BUT.+ ALARM BUT.+16A KAPAKLI PRİZ KOMBİNASYON
ADET/KOLİ	5
FİYAT (₺)	334,32



ÜRÜN KODU	010 104 000142
ÜRÜN ADI	MS-KY3ES5012 KOR.ACİL STOP BUT.+ALARM+9V PİLLİ 130 dB KOMBİNASYON
ADET/KOLİ	5
FİYAT (₺)	542,14



ÜRÜN KODU	010 104 000143
ÜRÜN ADI	MS-KY4ES5012 KOR.ACİL STOP BUT. +9V PİLLİ 130 dB ALARM + 16A KAP. PRİZ KOMBİNASYON
ADET/KOLİ	4
FİYAT (₺)	601,29



ÜRÜN KODU	010 091 020001
ÜRÜN ADI	MS-LV4 YUKARI (1NO) AŞAĞI (1NO) 0-1 REVİZYON (1NO) ACİL STOP BUT. (1NC) EL TERMİNALİ (EL KUMANDA)
ADET/KOLİ	6
FİYAT (₺)	425,38



ÜRÜN KODU	010 104 000145
ÜRÜN ADI	MS-LV5 YUKARI (1NO) ORTAK (1NO) AŞAĞI (1NO) 0-1 REVİZYON (1NO) ACİL STOP BUT.(1NC) 16A KAP. PRİZ EL TERMİNALİ
ADET/KOLİ	4
FİYAT (₺)	601,29



ÜRÜN KODU	010 104 000146
ÜRÜN ADI	MS3BY-BG53P 3KD. BY-PASSLI LAMBA BUT.(1NO) 24V KATTA LEDLİ REG.AÇMA (1NO) 16A KAP.PRİZ KOMBİNASYON
ADET/KOLİ	4
FİYAT (₺)	822,25



ÜRÜN KODU	010 104 000147
ÜRÜN ADI	MS9-BX07 YUKARI (1NO) AŞAĞI (1NO) ORTAK (1NO) 24V KATTA LEDLİ KOR.ACİL STOP(1NC) ALR. (1NO)LAM.(1NO) KOR.0-1REV.(1NO)16A
ADET/KOLİ	1
FİYAT (₺)	885,5



ÜRÜN KODU	010 104 000148
ÜRÜN ADI	MS102-ED21 3BY 3KD.BYP REG.KİL. (1NO) REG.AÇ(1NO) 24V KATTA LED FREN AÇMA (1NO) KOR.0-1SET RESET (1NO)
ADET/KOLİ	4
FİYAT (₺)	912,61



ÜRÜN KODU	010 104 000149
ÜRÜN ADI	MS201-ED21 REG.AÇ KAPA (2NO)24V KATTA LED LAMBA BUT. (1NO) FREN AÇMA1 (1NO) FREN AÇMA2(1NO)KOR.SET RESET (2NO)
ADET/KOLİ	4
FİYAT (₺)	609,91



010 104 000150



010 104 000151



010 104 000152

LİFT KUMANDA BUTONU - ÇİFT KONTAKLI

Ürün Kodu	Ürün Adı	Koli Adet	Fiyat (₺)
010 104 000150	MLK-2 TEK HIZLI 2'Lİ LİFT KUMANDA - ÇİFT KONTAKLI -10A	1	903,57
010 104 000151	MLK-3 TEK HIZLI 3'LÜ LİFT KUMANDA - ÇİFT KONTAKLI -10A	1	1.219,82
010 104 000152	MLK-4 TEK HIZLI 4'LÜ LİFT KUMANDA - ÇİFT KONTAKLI -10A	1	1.414,09



010 092 000001



010 092 000002



010 092 000003



010 092 000004



010 092 000005



010 092 000006

VİNÇ KUTULARI

Ürün Kodu	Ürün Adı	Koli Adet	Fiyat (₺)
010 092 000001	İKİLİ VİNÇ KUTUSU - TEK HIZLI	1	621,21
010 092 000002	ÜÇLÜ VİNÇ KUTUSU - TEK HIZLI	1	709,3
010 092 000003	DÖRTLÜ VİNÇ KUTUSU - TEK HIZLI	1	799,66
010 092 000004	BEŞLİ VİNÇ KUTUSU - TEK HIZLI	1	890,02
010 092 000005	ALTILI VİNÇ KUTUSU - TEK HIZLI	1	1.084,29
010 092 000006	YEDİLİ VİNÇ KUTUSU - TEK HIZLI	1	1.174,64



010 104 000003



010 104 000004



010 104 000005



010 104 000006



010 104 000007



010 104 000008

SWISS SERİSİ PLASTİK YAYLI BUTONLAR

Ürün Kodu	Ürün Adı	Koli Adet	Fiyat (₺)
010 104 000003	SW-AA42 22 mm PLASTİK YAYLI BUTON - STOP	10	47,89
010 104 000004	SW-AA31 22 mm PLASTİK YAYLI BUTON - START	10	47,89
010 104 000005	SW-AA51 22 mm PLASTİK YAYLI BUTON - START	10	47,89
010 104 000006	SW-AA61 22 mm PLASTİK YAYLI BUTON - START	10	47,89
010 104 000007	SW-AA21 22 mm PLASTİK YAYLI BUTON - START	10	47,89
010 104 000008	SW-AA11 22 mm PLASTİK YAYLI BUTON - START	10	47,89

SWISS SERİSİ PLASTİK KALICI BUTONLAR

Ürün Kodu	Ürün Adı	Koli Adet	Fiyat (₺)
010 104 000195	SW-K42 22MM PLASTİK KALICI BUTON STOP (YENİ ÜRÜN)	10	90,36
010 104 000196	SW-K31 22MM PLASTİK KALICI BUTON START (YENİ ÜRÜN)	10	90,36
010 104 000197	SW-K51 22MM PLASTİK KALICI BUTON START (YENİ ÜRÜN)	10	90,36
010 104 000198	SW-K61 22MM PLASTİK KALICI BUTON START (YENİ ÜRÜN)	10	90,36
010 104 000199	SW-KA21 22MM PLASTİK KALICI BUTON START (YENİ ÜRÜN)	10	90,36
010 104 000200	SW-KA11 22MM PLASTİK KALICI BUTON START (YENİ ÜRÜN)	10	90,36



010 104 00009



010 104 000010



010 104 000011



010 104 000012



010 104 000013



010 104 000014

SWISS SERİSİ PLASTİK YAYLI BUTONLAR

Ürün Kodu	Ürün Adı	Koli Adet	Fiyat (₺)
010 104 000009	SW-AA4322 22 mm PLASTİK YAYLI BUTON - STOP	10	50,37
010 104 000010	SW-AA3361 22 mm PLASTİK YAYLI BUTON - START	10	50,37
010 104 000011	SW-AA3351 22 mm PLASTİK YAYLI BUTON - START	10	50,37
010 104 000012	SW-AA3341 22 mm PLASTİK YAYLI BUTON - START	10	50,37
010 104 000013	SW-AA3371 22 mm PLASTİK YAYLI BUTON - START	10	50,37
010 104 000014	SW-AA3381 22 mm PLASTİK YAYLI BUTON - START	10	50,37



010 104 000015



010 104 000016



010 104 000017



010 104 000018



010 104 000019



010 104 000020



010 104 000021



010 104 000022



010 104 000023



010 104 000024

SWISS SERİSİ PLASTİK YAYLI İKİZ BUTONLAR

Ürün Kodu	Ürün Adı	Koli Adet	Fiyat (₺)
010 104 000015	SW-AL7325 22 mm PLASTİK İKİZ BUTON (1NO+1NC)	10	98,26
010 104 000016	SW-AL7181 22 mm PLASTİK ALARM - LAMBA İKİZ BUTON (1NO+1NO)	10	108,02
010 104 000017	SW-AL4252 22 mm PLASTİK YUKARI AŞAĞI OKLU TERS YÖNLÜ İKİZ BUTON (1NO+1NO)	10	108,02
010 104 000018	SW-AL6171 22 mm PLASTİK ALARM ORTAK OKLU İKİZ BUTON (1NO+1NO)	10	108,02
010 104 000019	SW-AL6181 22 mm PLASTİK LAMBA ORTAK OKLU İKİZ BUTON (1NO+1NO)	10	108,02
010 104 000020	SW-AL7425 22 mm PLASTİK İŞARETLİ İKİZ BUTON (1NO+1NC)	10	108,02
010 104 000021	SW-AL7525 22 mm PLASTİK YAZILI İKİZ BUTON (1NO+1NC)	10	108,02
010 104 000022	SW-AL4151 22 mm PLASTİK YUKARI AŞAĞI OKLU BUTON (1NO+1NO)	10	108,02
010 104 000023	SW-AL7465L 22 mm PLASTİK İKİZ BUTON (1NO+1NC) LEDLİ 220V AC/DC	10	181,84
010 104 000024	SW-AL7465-24L 22 mm PLASTİK İKİZ BUTON (1NO+1NC) LEDLİ 24V AC/DC	10	181,84



010 104 000025



010 104 000026



010 104 000027



010 104 000028

SWISS SERİSİ PLASTİK KALICI VE KAYICI MANDAL BUTONLAR

Ürün Kodu	Ürün Adı	Koli Adet	Fiyat (₺)
010 104 000025	SW-AD21 PLASTİK KALICI 0 - 1 MANDAL BUTON (1NO)	10	56,47
010 104 000026	SW-AD41 PLASTİK KAYICI 0 - 1 MANDAL BUTON (1NO)	10	63,93
010 104 000027	SW-AD33 PLASTİK KALICI 2 - 0 - 1 MANDAL BUTON (1NO+1NO)	10	82,23
010 104 000028	SW-AD53 PLASTİK KAYICI 2 - 0 - 1 MANDAL BUTON (1NO+1NO)	10	89,68



010 104 000029



010 104 000030



010 104 000031



010 104 000032

SWISS SERİSİ PLASTİK ANAHTARLI KALICI VE KAYICI MANDAL BUTONLAR

Ürün Kodu	Ürün Adı	Koli Adet	Fiyat (₺)
010 104 000029	SW-AG21 PLASTİK KALICI 0 - 1 ANAHTARLI MANDAL BUTON (1NO)	10	149,99
010 104 000030	SW-AG41 PLASTİK KAYICI 0 - 1 ANAHTARLI MANDAL BUTON (1NO)	10	149,99
010 104 000031	SW-AG33 PLASTİK KALICI 2 - 0 - 1 ANAHTARLI MANDAL BUTON (1NO+1NO)	10	176,2
010 104 000032	SW-AG53 PLASTİK KAYICI 2 - 0 - 1 ANAHTARLI MANDAL BUTON (1NO+1NO)	10	176,2



010 104 000037



010 104 000038



010 104 000039

SWISS SERİSİ PLASTİK KAYICI MANTAR BUTONLAR

Ürün Kodu	Ürün Adı	Koli Adet	Fiyat (₺)
010 104 000037	SW-AC42 22 mm PLASTİK KAYICI MANDAL BUTON (1NC)	10	76,8
010 104 000038	SW-AC31 22 mm PLASTİK KAYICI MANDAL BUTON (1NO)	10	76,8
010 104 000039	SW-AC51 22 mm PLASTİK KAYICI MANDAL BUTON (1NO)	10	76,8



010 104 000033



010 104 000034



010 104 000035



010 104 000036

SWISS SERİSİ PLASTİK MANTAR ACİL STOP BUTONLAR

Ürün Kodu	Ürün Adı	Koli Adet	Fiyat (₺)
010 104 000033	SW-AS142 40 mm KAFA PLASTİK ANAHTARLI MANTAR BUTON (1NC) ACİL STOP	10	171,68
010 104 000034	SW-AS542E 40 mm KAFA PLASTİK MANTAR BUTON (1NC) ACİL STOP ETİKETLİ	10	85,84
010 104 000035	SW-AS542 40 mm KAFA PLASTİK MANTAR BUTON (1NC) ACİL STOP	10	72,29
010 104 000036	SW-AS442 30 mm KAFA PLASTİK MANTAR BUTON (1NC) ACİL STOP	10	89,61



010 104 000040



010 104 000041



010 104 000042



010 104 000043



010 104 000044



010 104 000045



010 104 000046



010 104 000047

SWISS SERİSİ PLASTİK LEDLİ, IŞIKLI, YAYLI BUTONLAR

Ürün Kodu	Ürün Adı	Koli Adet	Fiyat (₺)
010 104 000040	SW-AW3475 22 mm LEDLİ IŞIKLI YAYLI BUTON STOP - 110-240V AC	10	140,05
010 104 000041	SW-AW3475 22 mm LEDLİ IŞIKLI YAYLI BUTON STOP - 10-30V DC	10	140,05
010 104 000042	SW-AW3375 22 mm LEDLİ IŞIKLI YAYLI BUTON START - 110-240V AC	10	140,05
010 104 000043	SW-AW3375-24 22 mm LEDLİ IŞIKLI YAYLI BUTON START - 10-30V DC	10	140,05
010 104 000044	SW-AW3575 22 mm LEDLİ IŞIKLI YAYLI BUTON START - 110-240V AC	10	140,05
010 104 000045	SW-AW3575-24 22 mm LEDLİ IŞIKLI YAYLI BUTON START - 10-30V DC	10	140,05
010 104 000046	SW-AW3675 22 mm LEDLİ IŞIKLI YAYLI BUTON START - 110-240V AC	10	140,05
010 104 000047	SW-AW3675-24 22 mm LEDLİ IŞIKLI YAYLI BUTON START - 10-30V DC	10	140,05



010 104 000001



010 104 000002

POTANSİYOMETRE

Ürün Kodu	Ürün Adı	Koli Adet	Fiyat (₺)
010 104 000001	MS22-5K POTANS 5K	15	271,07
010 104 000002	MS22-10K POTANS 10K	15	271,07



010 104 000054



010 104 000055



010 104 000056



010 104 000057



010 104 000058



010 104 000059

SWISS SERİSİ 1-0-2 PLASTİK LEDLİ, IŞIKLI KALICI MANDAL BUTONLAR

Ürün Kodu	Ürün Adı	Koli Adet	Fiyat (₺)
010 104 000054	SW-AK323L 1-0-2 PLASTİK LEDLİ KALICI MANDAL BUTON (2NO) 110-240V AC	10	175,74
010 104 000055	SW-AK324L 1-0-2 PLASTİK LEDLİ KALICI MANDAL BUTON (2NC) 110-240V AC	10	175,74
010 104 000056	SW-AK325L 1-0-2 PLASTİK LEDLİ KALICI MANDAL BUTON (2NO) 110-240V AC	10	175,74
010 104 000057	SW-AK323-24L 1-0-2 PLASTİK LEDLİ KALICI MANDAL BUTON (2NO) 10-24V AC/DC	10	175,74
010 104 000058	SW-AK324-24L 1-0-2 PLASTİK LEDLİ KALICI MANDAL BUTON (2NC) 10-24V AC/DC	10	175,74
010 104 000059	SW-AK325-24L 1-0-2 PLASTİK LEDLİ KALICI MANDAL BUTON (2NO) 10-24V AC/DC	10	175,74



010 104 000048



010 104 000049



010 104 000050



010 104 000051



010 104 000052



010 104 000053

SWISS SERİSİ 0-1 PLASTİK LEDLİ, IŞIKLI KALICI MANDAL BUTONLAR

Ürün Kodu	Ürün Adı	Koli Adet	Fiyat (₺)
010 104 000048	SW-AK123L 0-1 PLASTİK LEDLİ KALICI MANDAL BUTON (1NO) 110-240V AC	10	149,09
010 104 000049	SW-AK124L 0-1 PLASTİK LEDLİ KALICI MANDAL BUTON (1NC) 110-240V AC	10	149,09
010 104 000050	SW-AK125L 0-1 PLASTİK LEDLİ KALICI MANDAL BUTON (1NO) 110-240V AC	10	149,09
010 104 000051	SW-AK123-24L 0-1 PLASTİK LEDLİ KALICI MANDAL BUTON (1NO) 10-24V AC/DC	10	149,09
010 104 000052	SW-AK124-24L 0-1 PLASTİK LEDLİ KALICI MANDAL BUTON (1NC) 10-24V AC/DC	10	149,09
010 104 000053	SW-AK125-24L 0-1 PLASTİK LEDLİ KALICI MANDAL BUTON (1NO) 10-24V AC/DC	10	149,09



010 104 000064

010 104 000065

010 104 000066

010 104 000067

010 104 000068

010 104 000069

SWISS SERİSİ METAL KAPLAMALI YAYLI BUTONLAR

Ürün Kodu	Ürün Adı	Koli Adet	Fiyat (₺)
010 104 000064	SW-BA42 22 mm YAYLI BUTON STOP (1NC)	10	52,86
010 104 000065	SW-BA31 22 mm YAYLI BUTON START (1NO)	10	52,86
010 104 000066	SW-BA51 22 mm YAYLI BUTON START (1NO)	10	52,86
010 104 000067	SW-BA11 22 mm YAYLI BUTON START (1NO)	10	52,86
010 104 000068	SW-BA61 22 mm YAYLI BUTON START (1NO)	10	52,86
010 104 000069	SW-BA21 22 mm YAYLI BUTON START (1NO)	10	52,86

SWISS SERİSİ METAL KAPLAMALI KALICI BUTONLAR

Ürün Kodu	Ürün Adı	Koli Adet	Fiyat (₺)
010 104 000201	SW-BK42 22 MM YAYLI KALICI BUTON STOP (1NC) (YENİ ÜRÜN)	10	97.13
010 104 000202	SW-BK31 22 MM YAYLI KALICI BUTON START (1NC) (YENİ ÜRÜN)	10	97.13
010 104 000203	SW-BK51 22 MM YAYLI KALICI BUTON START (1NC) (YENİ ÜRÜN)	10	97.13
010 104 000204	SW-BK11 22 MM YAYLI KALICI BUTON START (1NC) (YENİ ÜRÜN)	10	97.13
010 104 000205	SW-BK61 22 MM YAYLI KALICI BUTON START (1NC) (YENİ ÜRÜN)	10	97.13
010 104 000206	SW-BK21 22 MM YAYLI KALICI BUTON START (1NC) (YENİ ÜRÜN)	10	97.13



010 104 000071

010 104 000072

010 104 000073

010 104 000074

010 104 000075

010 104 000076

SWISS SERİSİ METAL KAPLAMALI İŞARETLİ YAYLI BUTONLAR

Ürün Kodu	Ürün Adı	Koli Adet	Fiyat (₺)
010 104 000071	SW-BA4322 22 mm İŞARETLİ YAYLI BUTON STOP (1NC)	10	57,83
010 104 000072	SW-BA3351 22 mm İŞARETLİ YAYLI BUTON START (1NO)	10	57,83
010 104 000073	SW-BA3341 22 mm İŞARETLİ YAYLI BUTON START (1NO)	10	57,83
010 104 000074	SW-BA3361 22 mm İŞARETLİ YAYLI BUTON START (1NO)	10	57,83
010 104 000075	SW-BA3371 22 mm İŞARETLİ YAYLI BUTON START (1NO)	10	57,83
010 104 000076	SW-BA3381 22 mm İŞARETLİ YAYLI BUTON START (1NO)	10	57,83



010 104 000077

010 104 000078

010 104 000079

SWISS SERİSİ METAL KAPLAMALI İKİZ BUTONLAR

Ürün Kodu	Ürün Adı	Koli Adet	Fiyat (₺)
010 104 000077	SW-BL7325 22 mm PLASTİK İKİZ BUTON (1NO+1NC)	10	107,98
010 104 000078	SW-BL7425 22 mm PLASTİK İKİZ BUTON (1NO+1NC)	10	119,27
010 104 000079	SW-BL7525 22 mm PLASTİK YAZILI İKİZ BUTON (1NO+1NC)	10	119,27



010 104 000080

010 104 000081

010 104 000082

010 104 000083

010 104 000084

010 104 000085

010 104 000086

SWISS SERİSİ METAL KAPLAMALI İKİZ BUTONLAR

Ürün Kodu	Ürün Adı	Koli Adet	Fiyat (₺)
010 104 000080	SW-BL4151 22 mm PLASTİK YUKARI AŞAĞI OKLU İKİZ BUTON (1NO+1NO)	10	119,27
010 104 000081	SW-BL4252 22 mm PLASTİK YUKARI AŞAĞI TERS YÖN OKLU İKİZ BUTON (1NO+1NO)	10	119,27
010 104 000082	SW-BL6171 22 mm PLASTİK ALARM ORTAK OKLU İKİZ BUTON (1NO+1NO)	10	119,27
010 104 000083	SW-BL7181 22 mm PLASTİK ALARM - LAMBA İKİZ BUTON (1NO+1NO)	10	119,27
010 104 000084	SW-BL6181 22 mm PLASTİK LAMBA ORTAK OKLU İKİZ BUTON (1NO+1NO)	10	119,27
010 104 000085	SW-BL7465L 22 mm PLASTİK İKİZ BUTON LEDLİ (220V AC)	10	200,14
010 104 000086	SW-BL7465L-24L 22 mm PLASTİK İKİZ BUTON LEDLİ (24V AC/DC)	10	200,14



010 104 000087



010 104 000088



010 104 000089



010 104 000090

SWISS SERİSİ METAL KAPLAMALI KALICI VE KAYICI MANDAL BUTONLAR

Ürün Kodu	Ürün Adı	Koli Adet	Fiyat (₺)
010 104 000087	SW-BD21 0-1 KALICI MANDAL BUTON (1NO)	10	62,12
010 104 000088	SW-BD41 0-1 KAYICI MANDAL BUTON (1NO)	10	70,25
010 104 000089	SW-BD33 1-0-2 KALICI MANDAL BUTON (1NO+1NO)	10	90,36
010 104 000090	SW-BD53 1-0-2 KAYICI MANDAL BUTON (1NO+1NO)	10	98,94



010 104 000168



010 104 000169



010 104 000170



010 104 000171



010 104 000172



010 104 000173

SWISS SERİSİ METAL KAPLAMALI 0-1 LEDLİ KALICI BUTONLAR

Ürün Kodu	Ürün Adı	Koli Adet	Fiyat (₺)
010 104 000168	SW-BK123L 0-1 LEDLİ İŞIKLI KALICI MANDAL BUTON (1NO) 110-240V AC	10	156,54
010 104 000169	SW-BK124L 0-1 LEDLİ İŞIKLI KALICI MANDAL BUTON (1NC) 110-240V AC	10	156,54
010 104 000170	SW-BK125L 0-1 LEDLİ İŞIKLI KALICI MANDAL BUTON (1NO) 110-240V AC	10	156,54
010 104 000171	SW-BK123L-24L 0-1 LEDLİ İŞIKLI KALICI MANDAL BUTON (1NO) 10-30V AC/DC	10	156,54
010 104 000172	SW-BK124L-24L 0-1 LEDLİ İŞIKLI KALICI MANDAL BUTON (1NC) 10-30V AC/DC	10	156,54
010 104 000173	SW-BK125L-24L 0-1 LEDLİ İŞIKLI KALICI MANDAL BUTON (1NC) 10-30V AC/DC	10	156,54



010 104 000160



010 104 000162



010 104 000164



010 104 000166



010 104 000161



010 104 000163



010 104 000165



010 104 000167

SWISS SERİSİ METAL KAPLAMALI LEDLİ İŞIKLI YAYLI BUTONLAR

Ürün Kodu	Ürün Adı	Koli Adet	Fiyat (₺)
010 104 000160	BW-3475 22 mm LEDLİ İŞIKLI YAYLI BUTON STOP 110-240V AC	10	143,67
010 104 000161	BW-3475-24L 22 mm LEDLİ İŞIKLI YAYLI BUTON STOP 10-30V AC/DC	10	143,67
010 104 000162	BW-3375 22 mm LEDLİ İŞIKLI YAYLI BUTON START 110-240V AC	10	143,67
010 104 000163	BW-3375-24L 22 mm LEDLİ İŞIKLI YAYLI BUTON START 10-30V AC/DC	10	143,67
010 104 000164	BW-3575 22 mm LEDLİ İŞIKLI YAYLI BUTON START 110-240V AC	10	143,67
010 104 000165	BW-3575-24L 22 mm LEDLİ İŞIKLI YAYLI BUTON START 10-30V AC/DC	10	143,67
010 104 000166	BW-3675 22 mm LEDLİ İŞIKLI YAYLI BUTON START 110-240V AC	10	143,67
010 104 000167	BW-3675-24L 22 mm LEDLİ İŞIKLI YAYLI BUTON START 10-30V AC/DC	10	143,67



010 104 000174



010 104 000175



010 104 000176



010 104 000177



010 104 000178



010 104 000179

SWISS SERİSİ METAL KAPLAMALI 0-1-2 LEDLİ KALICI MANDAL BUTONLAR

Ürün Kodu	Ürün Adı	Koli Adet	Fiyat (₺)
010 104 000174	BK-323L 1-0-2 PLASTİK LEDLİ KALICI MANDAL BUTON (2NO) 110-240V AC	10	182,63
010 104 000175	BK-324L 1-0-2 PLASTİK LEDLİ KALICI MANDAL BUTON (2NC) 110-240V AC	10	182,63
010 104 000176	BK-325L 1-0-2 PLASTİK LEDLİ KALICI MANDAL BUTON (2NO) 110-240V AC	10	182,63
010 104 000177	BK-323-24L 1-0-2 PLASTİK LEDLİ KALICI MANDAL BUTON (2NO) 10-24V AC/DC	10	182,63
010 104 000178	BK-324-24L 1-0-2 PLASTİK LEDLİ KALICI MANDAL BUTON (2NC) 10-24V AC/DC	10	182,63
010 104 000179	BK-325-24L 1-0-2 PLASTİK LEDLİ KALICI MANDAL BUTON (2NO) 10-24V AC/DC	10	182,63



010 104 000060



010 104 000061



010 104 000062

YAYLI BUTON YEDEK KONTAKLARI VE KILIFI

Ürün Kodu	Ürün Adı	Koli Adet	Fiyat (₺)
010 104 000060	SW-BE101 KONTAK BLOK (NO)	50	26,66
010 104 000061	SW-BE102 KONTAK BLOK (NC)	50	26,66
010 104 000062	SW-BE103 İŞIK SOKETİ 10/30 110-240V AC	50	92,62



010 104 000091



010 104 000092



010 104 000093



010 093 000002



010 093 000001



010 093 000099

BUTON AKSESUARLARI

Ürün Kodu	Ürün Adı	Koli Adet	Fiyat (₺)
010 104 000091	SW-BR1 PLASTİK BUTON ROZETİ 26x8 CAMLI	100	18,07
010 104 000092	SW-BR2 PLASTİK BUTON ROZETİ 26x18 CAMLI	100	20,33
010 104 000093	SW-SİE-R PLASTİK BUTON ROZETİ 27x12 CAMSIZ	100	16,19
010 093 000002	SW-BRY PLASTİK YAZILI BUTON ROZETİ	100	11,64
010 093 000001	SW-AP2 BUTON KORUMA KILIFI (YAYLI BUTONLAR İÇİN)	50	22,59
010 104 000099	SW-AP4 BUTON KORUMA KILIFI (YAYLI BUTONLAR İÇİN)	50	22,59



010 104 000095



010 104 000096



010 093 000003



010 090 050008



010 104 000101



010 104 000102



010 104 000104

ACİL STOP ETİKETLERİ

Ürün Kodu	Ürün Adı	Koli Adet	Fiyat (₺)
010 104 000095	SW-ER60TE Ø60 mm PLASTİK ACİL DURDURMA + EMERGENCY ROZETİ (KALIN TİP) LAZER BASKI	50	22,59
010 104 000096	SW-ER60EN-Y Ø60 mm PLASTİK EMERGENCY ROZETİ (İNCE TİP) LAZER BASKI	50	17,17
010 093 000003	ACİL DURDURMA ETİKETİ	50	16,19
010 090 050008	SW-AKKM EMNİYET BASMA DÜĞMESİ MUHAFAZA	50	15,88
010 104 000101	SW-AKK ACİL STOP KORUMA KAPAĞI	50	31,63
010 104 000102	SW-AKKY ACİL STOP KORUMA KAPAĞI	50	32,53
010 104 000104	SW-MKKY MANDAL BUTON KORUMA KAPAĞI	50	31,63



999 999 995000



999 999 995001



999 999 995002

VOLTMETRE VE AMPERMETRE

Ürün Kodu	Ürün Adı	Koli Adet	Fiyat (₺)
999 999 995000	22 mm VOLTMETRE PLASTİK LED GÖSTERGELİ 12-500V AC	10	172,92
999 999 995001	22 mm AMPERMETRE (AKIM TRAFOLU) PLS. LED GÖS. 1A-100A AC / 60-380V AC	10	334,32
999 999 995002	22 mm VOLT + AMPERMETRE (AKIM TRAFOLU) PLS. LED GÖS. 12-500V AC / 1A-100A AC	10	426



010 104 000063



010 104 000193



010 104 000194

BUTON SIVIÇ

Ürün Kodu	Ürün Adı	Koli Adet	Fiyat (₺)
010 104 000063	MS-1010 (1NO)	50	60,13
010 104 000193	MS-1011 (1NK)	50	60,12
010 104 000194	MS-1012 (1NA+1NK)	50	90,36



010 090 010001



010 090 010005



010 090 010006



010 090 010007



010 090 010008



010 090 010009



010 090 010010

MUTLUSAN SİNYAL VE KUMANDA BUTONLARI

Ürün Kodu	Ürün Adı	Koli Adet	Fiyat (₺)
010 090 010001	10 mm KABLolu SİNYAL ARMATÜRÜ	100	14,73
010 090 010005	14 mm KABLolu SİNYAL ARMATÜRÜ - 12V	50	18,52
010 090 010006	14 mm KABLolu SİNYAL ARMATÜRÜ - 24V	50	18,52
010 090 010007	14 mm KABLolu SİNYAL ARMATÜRÜ - 220V	50	18,52
010 090 010008	22 mm KABLolu SİNYAL ARMATÜRÜ - 12V	24	20,87
010 090 010009	22 mm KABLolu SİNYAL ARMATÜRÜ - 24V	24	20,87
010 090 010010	22 mm KABLolu SİNYAL ARMATÜRÜ - 220V	24	20,87



010 090 010004



010 090 070002



010 111 070001



010 111 070002



010 111 070003



010 111 070004

MUTLUSAN SİNYAL VE KUMANDA BUTONLARI

Ürün Kodu	Ürün Adı	Koli Adet	Fiyat (₺)
010 090 010004	22 mm SİNYAL ARM. LEDLİ - 220V	24	28,24
010 090 070002	22 mm SİNYAL ARM. LEDLİ - 24V	24	28
010 111 070001	BUZZER LEDLİ - 220V	24	127,45
010 111 070002	BUZZER LEDLİ - 24V	24	127,45
010 111 070003	BUZZER - 220V	24	101,65
010 111 070004	BUZZER LEDLİ - 24V	24	101,65



Ürün Kodu	Çap (Ø)	Ürün Adı	Çalışma Şekli	Besleme Gerilimi	Adet	Fiyat
PRO SERİSİ 1 KATLI RGB METAL MULTİ RENK İKAZ LAMBALARI						
129 087 000606	Ø50	PRO-X324	SABİT	24V DC	1	182,94 \$
129 087 000607		PRO-X324B	SABİT + BUZZER	24V DC	1	221,06 \$
T6 SERİSİ RGB METAL MULTİ RENK İKAZ LAMBALARI						
129 087 000671	Ø60	M-T6-243	MULTİ	24 V DC	1	38,12 \$
129 087 000672		M-T6-223	MULTİ	220V AC	1	45,75 \$
129 087 000673		MB-T6-243	MULTİ + BUZZER	24V DC	1	45,75 \$
129 087 000674		MB-T6-223	MULTİ + BUZZER	220V AC	1	53,38 \$
R6 SERİSİ RGB METAL MULTİ RENK İKAZ LAMBALARI						
129 087 000675	Ø60	M-R6-243	MULTİ	24 V DC	1	38,12 \$
129 087 000676		M-R6-223	MULTİ	220V AC	1	45,75 \$
129 087 000677		MB-R6-243	MULTİ + BUZZER	24V DC	1	45,75 \$
129 087 000678		MB-R6-223	MULTİ + BUZZER	220V AC	1	53,38 \$
T7K SERİSİ RGB METAL MULTİ RENK İKAZ LAMBALARI						
129 087 000679	Ø70	M-T7K-243	MULTİ	24 V DC	1	38,12 \$
129 087 000680		M-T7K-223	MULTİ	220V AC	1	45,75 \$
129 087 000681		MB-T7K-243	MULTİ + BUZZER	24V DC	1	45,75 \$
129 087 000682		MB-T7K-223	MULTİ + BUZZER	220V AC	1	53,38 \$
R7K SERİSİ RGB METAL MULTİ RENK İKAZ LAMBALARI						
129 087 000683	Ø70	M-R7K-243	MULTİ	24 V DC	1	38,12 \$
129 087 000684		M-R7K-223	MULTİ	220V AC	1	45,75 \$
129 087 000685		MB-R7K-243	MULTİ + BUZZER	24V DC	1	45,75 \$
129 087 000686		MB-R7K-223	MULTİ + BUZZER	220V AC	1	53,38 \$
V7K SERİSİ RGB METAL MULTİ RENK İKAZ LAMBALARI						
129 087 000687	Ø70	M-V7K-243	MULTİ	24 V DC	1	38,12 \$
129 087 000688		M-V7K-223	MULTİ	220V AC	1	45,75 \$
129 087 000689		MB-V7K-243	MULTİ + BUZZER	24V DC	1	45,75 \$
129 087 000690		MB-V7K-223	MULTİ + BUZZER	220V AC	1	53,38 \$
QH SERİSİ RGB METAL MULTİ RENK İKAZ LAMBALARI						
129 087 000691	Ø70	M-QH-324	MULTİ	24 V DC	1	60,98 \$
129 087 000692		M-QH-322	MULTİ	220V AC	1	68,61 \$
129 087 000693		MB-QH-324	MULTİ + BUZZER	24V DC	1	68,61 \$
129 087 000694		MB-QH-322	MULTİ + BUZZER	220V AC	1	76,23 \$
BH SERİSİ RGB METAL MULTİ RENK İKAZ LAMBALARI						
129 087 000695	Ø70	M-BH-324	MULTİ	24 V DC	1	60,98 \$
129 087 000696		M-BH-322	MULTİ	220V AC	1	68,61 \$
129 087 000697		MB-BH-324	MULTİ + BUZZER	24V DC	1	68,61 \$
129 087 000698		MB-BH-322	MULTİ + BUZZER	220V AC	1	76,23 \$
BH SERİSİ MULTİ 105 dB 1-2-3 KATLI BORULU KORNALAR						
129 087 000401		M-BH-241	MULTİ	24 V DC	1	60,98 \$
129 087 000403		M-BH-221	MULTİ	220V AC	1	68,61 \$
129 087 000405		M-BH-242	MULTİ	24 V DC	1	91,49 \$
129 087 000407		M-BH-222	MULTİ	220V AC	1	106,72 \$
129 087 000409		M-BH-243	MULTİ	24 V DC	1	106,72 \$
129 087 000411		M-BH-223	MULTİ	220V AC	1	121,98 \$
QH SERİSİ MULTİ 105 dB 1-2-3 KATLI BORULU KORNALAR						
129 087 000400		M-QH-241	MULTİ	24 V DC	1	60,98 \$
129 087 000402		M-QH-221	MULTİ	220V AC	1	68,61 \$
129 087 000404		M-QH-242	MULTİ	24 V DC	1	91,49 \$
129 087 000406		M-QH-222	MULTİ	220V AC	1	106,72 \$
129 087 000408		M-QH-243	MULTİ	24 V DC	1	106,72 \$
129 087 000410		M-QH-223	MULTİ	220V AC	1	121,97 \$
B-B SERİSİ Ø70 BORULU KORNALAR (SÜREKLİ - KESİK KESİK)						
129 087 000230		B-B-24	95dB/30cm	24 V	1	39,64 \$
129 087 000233		B-B-220	95dB/30cm	220V	1	39,64 \$
129 087 000631		B-BH-24	115dB/30cm	24 V	1	47,27 \$
129 087 000632		B-BH-220	115dB/30cm	220V	1	47,27 \$
B-Q SERİSİ Ø70 BORULU KORNALAR (SÜREKLİ - KESİK KESİK)						
129 087 000235		B-Q-24	95dB/30cm	24 V	1	39,64 \$
129 087 000238		B-Q-220	95dB/30cm	220V	1	39,64 \$
129 087 000633		B-QH-24	115dB/30cm	24 V	1	47,27 \$
129 087 000634		B-QH-220	115dB/30cm	220V	1	47,27 \$
FM SERİSİ BUZZER (SÜREKLİ - KESİK KESİK)						
129 087 000245		FM-12A-905AL70	90dB/30cm	12 V	1	24,39 \$
129 087 000246		FM-12Q-905L70	95dB/60cm	12 V	1	24,39 \$
129 087 000247		FM-24C-905L70	92dB/100cm	24 V	1	24,39 \$
129 087 000248		FM-220A-905AL70	95dB/30cm	220V	1	27,44 \$
129 087 000249		FM-24C-900L700	92dB/100cm	24 V	1	21,34 \$
129 087 000250		FM-220A-905A	90dB/300cm	220 V	1	27,44 \$
129 087 000251		FM-12A-905A	90dB/30cm	12 V	1	24,39 \$
129 087 000252		FM-120Q-905	90dB/30cm	12 V	1	21,34 \$



Ürün Kodu	Ürün Adı	Çalışma Şekli	Besleme Gerilimi	Adet	Fiyat
PRO SERİSİ 1 KATLI IŞIKLI KOLONLAR					
129 087 000608	PRO-241	SABİT	24V DC	1	189,75 \$
129 087 000609	PRO-241B	SABİT + BUZZER	24V DC	1	213,47 \$
PRO SERİSİ 2 KATLI IŞIKLI KOLONLAR					
129 087 000610	PRO-242	SABİT	24 V DC	1	213,47 \$
129 087 000611	PRO-242B	SABİT + BUZZER	220V AC	1	237,18 \$
PRO SERİSİ 3 KATLI IŞIKLI KOLONLAR					
129 087 000612	PRO-242	SABİT	24 V DC	1	237,18 \$
129 087 000613	PRO-242B	SABİT + BUZZER	220V AC	1	260,9 \$
PRO SERİSİ 4 KATLI IŞIKLI KOLONLAR					
129 087 000614	PRO-244	SABİT	24 V DC	1	260,9 \$
129 087 000615	PRO-244B	SABİT + BUZZER	220V AC	1	284,62 \$
PRO SERİSİ 5 KATLI IŞIKLI KOLONLAR					
129 087 000616	PRO-245	SABİT	24 V DC	1	284,62 \$
129 087 000617	PRO-245B	SABİT + BUZZER	220V AC	1	308,35 \$
T5 SERİSİ 1 KATLI IŞIKLI KOLONLAR					
129 087 000278	S-T5-241	SABİT	24 V DC	1	38,12 \$
129 087 000279	S-T5-221	SABİT	220V AC	1	45,75 \$
129 087 000281	F-T5-241	FLAŞÖRLÜ	24V DC	1	59,46 \$
129 087 000282	F-T5-221	FLAŞÖRLÜ	220V AC	1	64,03 \$
129 087 000284	Ç-T5-241	ÇAKAR	24 V DC	1	59,46 \$
129 087 000285	Ç-T5-221	ÇAKAR	220V AC	1	64,03 \$
129 087 000287	SB-T5-241	SABİT+BUZZER	24V DC	1	62,51 \$
129 087 000288	SB-T5-221	SABİT+BUZZER	220V AC	1	70,13 \$
129 087 000290	FB-T5-241	FLAŞÖRLÜ+BUZZER	24V DC	1	74,7 \$
129 087 000291	FB-T5-221	FLAŞÖRLÜ+BUZZER	220V AC	1	82,34 \$
T5 SERİSİ 2 KATLI IŞIKLI KOLONLAR					
129 087 000296	S-T5-242	SABİT	24 V DC	1	54,9 \$
129 087 000297	S-T5-222	SABİT	220V AC	1	57,93 \$
129 087 000299	F-T5-242	FLAŞÖRLÜ	24V DC	1	65,56 \$
129 087 000300	F-T5-222	FLAŞÖRLÜ	220V AC	1	77,75 \$
129 087 000302	SB-T5-242	SABİT+BUZZER	24 V DC	1	71,66 \$
129 087 000303	SB-T5-222	SABİT+BUZZER	220V AC	1	79,28 \$
129 087 000305	FB-T5-242	FLAŞÖRLÜ+BUZZER	24V DC	1	80,81 \$
129 087 000306	FB-T5-222	FLAŞÖRLÜ+BUZZER	220V AC	1	88,44 \$
T5 SERİSİ 3 KATLI IŞIKLI KOLONLAR					
129 087 000308	S-T5-243	SABİT	24 V DC	1	57,93 \$
129 087 000309	S-T5-223	SABİT	220V AC	1	62,51 \$
129 087 000311	F-T5-243	FLAŞÖRLÜ	24V DC	1	74,7 \$
129 087 000312	F-T5-223	FLAŞÖRLÜ	220V AC	1	82,34 \$
129 087 000314	SB-T5-243	SABİT+BUZZER	24 V DC	1	89,97 \$
129 087 000315	SB-T5-223	SABİT+BUZZER	220V AC	1	97,57 \$
129 087 000317	FB-T5-243	FLAŞÖRLÜ+BUZZER	24V DC	1	97,57 \$
129 087 000318	FB-T5-223	FLAŞÖRLÜ+BUZZER	220V AC	1	106,72 \$
T7 SERİSİ 1 KATLI IŞIKLI KOLONLAR					
129 087 000651	M-T7-241	MULTİ	24 V DC	1	30,49 \$
129 087 000652	M-T7-221	MULTİ	220V AC	1	38,12 \$
129 087 000653	MB-T7-241	MULTİ + BUZZER	24V DC	1	45,75 \$
129 087 000654	MB-T7-221	MULTİ + BUZZER	220V AC	1	53,38 \$
T7 SERİSİ 2 KATLI IŞIKLI KOLONLAR					
129 087 000655	M-T7-242	MULTİ	24 V DC	1	45,75 \$
129 087 000656	M-T7-222	MULTİ	220V AC	1	58,84 \$
129 087 000657	MB-T7-242	MULTİ + BUZZER	24V DC	1	60,98 \$
129 087 000658	MB-T7-222	MULTİ + BUZZER	220V AC	1	68,61 \$
T7 SERİSİ 3 KATLI IŞIKLI KOLONLAR					
129 087 000659	M-T7-243	MULTİ	24 V DC	1	53,38 \$
129 087 000660	M-T7-223	MULTİ	220V AC	1	79,2 \$
129 087 000661	MB-T7-243	MULTİ + BUZZER	24V DC	1	68,61 \$
129 087 000662	MB-T7-223	MULTİ + BUZZER	220V AC	1	76,23 \$
T7 SERİSİ 4 KATLI IŞIKLI KOLONLAR					
129 087 000663	M-T7-244	MULTİ	24 V DC	1	74,25 \$
129 087 000664	M-T7-224	MULTİ	220V AC	1	82,5 \$
129 087 000665	MB-T7-244	MULTİ + BUZZER	24V DC	1	82,5 \$
129 087 000666	MB-T7-224	MULTİ + BUZZER	220V AC	1	99,38 \$
T7 SERİSİ 5 KATLI IŞIKLI KOLONLAR					
129 087 000667	M-T7-245	MULTİ	24 V DC	1	82,5 \$
129 087 000668	M-T7-225	MULTİ	220V AC	1	90,75 \$
129 087 000669	MB-T7-245	MULTİ + BUZZER	24V DC	1	90,75 \$
129 087 000670	MB-T7-225	MULTİ + BUZZER	220V AC	1	99,37 \$



PRO
Ø50



T5
Ø50



T7
Ø70
multi

IŞIKLI KOLONLARDA KIRMIZI SABİT RENKTİR. DİĞER RENKLER SİPARİŞLE YAPILIP, İADESİ YOKTUR.



Ürün Kodu	Çap (Ø)	Ürün Adı	Çalışma Şekli	Besleme Gerilimi	Adet	Fiyat
-----------	---------	----------	---------------	------------------	------	-------

T6 SERİSİ MULTİ FONKSİYON İKAZ LAMBALARI

129 087 000441	Ø60	M-T6-24K	MULTİ	24 V DC	1	30,49 \$
129 087 000442		M-T6-22K	MULTİ	220V AC	1	43,6 \$
129 087 000443		MB-T6-24K	MULTİ + BUZZER	24V DC	1	38,12 \$
129 087 000444		MB-T6-22K	MULTİ + BUZZER	220V AC	1	45,75 \$

R6 SERİSİ MULTİ FONKSİYON İKAZ LAMBALARI

129 087 000635	Ø60	M-R6-24K	MULTİ	24 V DC	1	30,49 \$
129 087 000636		M-R6-22K	MULTİ	220V AC	1	38,12 \$
129 087 000637		MB-R6-24K	MULTİ + BUZZER	24V DC	1	38,12 \$
129 087 000638		MB-R6-22K	MULTİ + BUZZER	220V AC	1	45,75 \$

F7 SERİSİ 12...80V/DC MOBİL UYGULAMA İÇİN İKAZ LAMBALARI

129 087 000622	Ø70	M-F7-24K	MULTİ	24 V DC	1	60,98 \$
129 087 000623		M-F7-22K	MULTİ	220V AC	1	68,61 \$
129 087 000624		MB-F7-24K	MULTİ + BUZZER	24V DC	1	68,61 \$
129 087 000625		MB-F7-22K	MULTİ + BUZZER	220V AC	1	76,23 \$

T7K SERİSİ MULTİ FONKSİYON İKAZ LAMBALARI

129 087 000639	Ø70	M-T7K-24K	MULTİ	24 V DC	1	30,49 \$
129 087 000640		M-T7K-22K	MULTİ	220V AC	1	38,12 \$
129 087 000641		MB-T7K-24K	MULTİ + BUZZER	24V DC	1	45,75 \$
129 087 000642		MB-T7K-22K	MULTİ + BUZZER	220V AC	1	53,38 \$

V8 SERİSİ MULTİ FONKSİYON Q84 İKAZ LAMBALARI

129 087 000445	Ø80	M-V8-24K	MULTİ	24 V DC	1	60,98 \$
129 087 000446		M-V8-22K	MULTİ	220V AC	1	68,61 \$
129 087 000447		MB-V8-24K	MULTİ + BUZZER	24V DC	1	68,61 \$
129 087 000448		MB-V8-22K	MULTİ + BUZZER	220V AC	1	76,23 \$

T8 SERİSİ MULTİ FONKSİYON İKAZ LAMBALARI

129 087 000449	Ø80	M-T8-24K	MULTİ	24 V DC	1	65,56 \$
129 087 000450		M-T8-22K	MULTİ	220V AC	1	73,18 \$
129 087 000451		MB-T8-24K	MULTİ + BUZZER	24V DC	1	73,18 \$
129 087 000452		MB-T8-22K	MULTİ + BUZZER	220V AC	1	80,81 \$

VT8 SERİSİ MULTİ FONKSİYON Q84 İKAZ LAMBALARI

129 087 000453	Ø80	M-VT8-24K	MULTİ	24 V DC	1	65,56 \$
129 087 000454		M-VT8-22K	MULTİ	220V AC	1	73,18 \$
129 087 000455		MB-VT8-24K	MULTİ + BUZZER	24V DC	1	73,18 \$
129 087 000456		MB-VT8-22K	MULTİ + BUZZER	220V AC	1	80,81 \$

T9 SERİSİ MULTİ FONKSİYON İKAZ LAMBALARI

129 087 000457	Ø90	M-T9-24K	MULTİ	24 V DC	1	60,98 \$
129 087 000458		M-T9-22K	MULTİ	220V AC	1	68,61 \$
129 087 000459		MB-T9-24K	MULTİ + BUZZER	24V DC	1	68,61 \$
129 087 000460		MB-T9-22K	MULTİ + BUZZER	220V AC	1	76,23 \$

T10 SERİSİ MULTİ FONKSİYON İKAZ LAMBALARI

129 087 000643	Ø100	M-T10-24K	MULTİ	24 V DC	1	68,61 \$
129 087 000644		M-T10-22K	MULTİ	220V AC	1	76,23 \$
129 087 000645		MB-T10-24K	MULTİ + BUZZER	24V DC	1	76,23 \$
129 087 000646		MB-T10-22K	MULTİ + BUZZER	220V AC	1	83,86 \$

T12 SERİSİ MULTİ FONKSİYON İKAZ LAMBALARI

129 087 000647	Ø120	M-T12-24K	MULTİ	24 V DC	1	76,23 \$
129 087 000648		M-T12-22K	MULTİ	220V AC	1	83,86 \$
129 087 000649		MB-T12-24K	MULTİ + BUZZER	24V DC	1	83,86 \$
129 087 000650		MB-T12-22K	MULTİ + BUZZER	220V AC	1	91,49 \$

HEAVY DUTY SERİSİ İKAZ LAMBALARI

Ürün Kodu	Ürün Adı	Çalışma Şekli	Besleme Gerilimi	Adet	Fiyat
129 087 000619	HD-22K	MULTİ	12-24V DC/220V AC	1	182,94 \$
129 087 000618	HD-22B	7 FARKLI SES	12-24V DC/220V AC	1	236,32 \$
129 087 000620	HD-22BK	MULTİ IŞIK+7 FARKLI SES	12-24V DC/220V AC	1	495,5 \$



Mutlusan Plastik Elektrik San ve Tic. A.Ş.

İkitelli Org.San. Bölgesi Mahallesi Enkoop Cad.
No:7 Başakşehir- İstanbul
Tel : +90 (212) 485 05 44 (PBX)
Faks : +90 (212) 485 10 12

Karaköy Şube

Okçumusa Cad. Güneşhan İş Hanı No : 24/10
Karaköy-İstanbul
Tel : +90 (212) 237 06 02 (PBX)
Faks: +90 (212) 237 77 47

Perpa Şube

Perpa Tic. Merkezi. A Blok Kat: 2
No: 9-009 Okmeydanı - İstanbul
Tel : +90 (212) 320 05 78 (PBX)
Faks: +90 (212) 320 05 81

mutlusan.com.tr