

FİYAT LİSTESİ 2024-2



YENİ

ŞALT GRUBU

Güvenliğiniz için...



@mutlusanplastikelektrik



@mutlusanelectric



@mutlusanelk



@mutlusanelektrik

içindekiler

anahtar priz grubu

| | |
|--------------------------|----|
| YENİ Araç Şarj Cihazları | 2 |
| YENİ Şalt Ürünleri | 4 |
| YENİ Modüler Sistem | 22 |
| Rita Serisi | 29 |
| Elitra Plus Serisi | 34 |
| Candela Serisi | 39 |
| YENİ Bella Serisi | 45 |
| YENİ Nora Serisi | 47 |
| Bron Serisi | 49 |
| Grup priz ve Aksesuarlar | 51 |

kablo kanalları, plastik, tesisat ve aydınlatma grubu

| | |
|--|----|
| Canalex serisi kapalı tip kablo kanalları | 61 |
| Eko serisi kapalı tip kablo kanalları | 61 |
| Yapışkan bantlı kapalı tip kablo kanalları | 61 |
| Meks serisi kapalı tip kablo kanalları | 62 |
| Meks serisi klima kanalı ve aksesuarları | 62 |
| Tavan köşe ve süpürgelik kablo kanalları | 62 |
| Fugalı ve tezgah süpürgeliği | 62 |
| Balık sırtı zemin kanalları | 62 |
| H.Free Flaret kanal ve aksesuarları | 63 |
| Kanal aksesuarları | 64 |
| Meks plus serisi için priz setleri | 66 |
| Kanal için ups ve enerji prizleri 45x45 | 67 |
| Kablo toplama spirali ve kablo omurga kanalı | 70 |
| Sidem serisi renkli kablo kanalları | 71 |
| Sidem serisi süpürgelikler ve aksesuarları | 71 |
| Comfort W otomat kutuları | 75 |
| Comfort zayıf akım kutuları | 75 |
| Meksbox W otomat kutuları | 76 |
| H. Free spiraller | 77 |
| Plastik spiraller | 78 |
| Hdpe koruge borular | 78 |
| Logar kutuları | 78 |
| Eko serisi çelik ve izole kaplı spiraller | 79 |
| Meks serisi çelik ve izole kaplı spiraller | 79 |
| Metal rakorlar | 80 |
| Pvc boy borular ve aksesuarları | 81 |
| Fiber kılavuz, çelik susta ve plastik sustalar | 81 |
| H.Free borular | 82 |
| PVC Boru aksesuarlar | 83 |
| Eko Serisi borular | 84 |
| Kalın boy boru ve dirsek-muflar | 85 |
| Poliyeten yeraltı boruları | 85 |
| Kasa, buat ve kapakları | 86 |
| Buatlar, çivili kroşeler | 87 |

| | |
|---|-----|
| Dübeller, kroşeler, toplama çubuğu | 88 |
| YENİ Elektrik izolasyon bandı | 89 |
| Kapı otomatığı, trafolar, ziller ve butonları | 91 |
| Telefon dağıtım kutu ve aksesuarları | 91 |
| Ledli flaşör lambaları ve motorlu sirenler | 92 |
| YENİ ME-FAN aspiratörler | 93 |
| Mutlusan aspiratörler | 94 |
| Led armatür ve armatür çeşitleri | 95 |
| YENİ Aplikler | 100 |
| YENİ Solar bahçe aplikleri | 102 |
| Bahçe armatürleri | 103 |
| Exit - acil aydınlatma armatürleri | 106 |

pano ve endüstriyel ürün grubu

| | |
|--|-----|
| Promex delikli kanallar | 108 |
| Delikli kablo kanalları | 111 |
| Promex Abs panoları ve otomat panoları | 112 |
| Pano prizleri | 114 |
| Abs pano aksesuarları | 115 |
| Higrostat ve termostatlar | 116 |
| Promex ve eko fan tepe fanları | 118 |
| Filtreli fanlar ve pano ısıtıcıları | 120 |
| R-Meks plastik kablo rakorları | 122 |
| Promex plastik kablo rakoru | 123 |
| Süper etanj plastik rakorlar | 125 |
| Polyamid spiral rakorları | 125 |
| YENİ UV Dayanımlı pano spiralleri, PP Spiraller | 126 |
| YENİ UV Kablo bağları, Mutlusan kablo bağları, yapışkan kroşeler | 127 |
| Ray klemensler ve dağıtım üniteleri | 129 |
| Geçmeli ve tırnaklı tip buat klemensler | 131 |
| Klemensler | 131 |
| YENİ Yüksükler | 132 |
| Baralar ve raylar | 140 |
| Skp çeşitleri | 141 |
| Sanayi tipi kauçuk fiş ve prizleri | 142 |
| Cee norm fiş ve prizler | 144 |
| Termoplastik buatlar ve kombinasyon kutuları | 148 |
| Kombinasyon panoları | 150 |
| Kumanda ve vinç kutuları | 151 |
| Butonlar ve potansiyometre | 155 |
| Ampermetre ve voltmetre | 162 |
| İkaz lambaları ve sirenler | 164 |
| Eko Serisi proje ürünleri | 165 |

Mutlusan
CHARGEBOX

YENİ



Senin Enerjin
Senin Mutluluğun...



Kullanım Kılavuzu
İçin Lütfen Okutunuz

Tak Çalıştır (Plug&Play):

Kurulumu kolay ve hızlı, hemen şarj etmeye başlayın.

RFID Kimlik Doğrulaması:

Kişiselleştirilmiş güvenlik ve kullanım kolaylığı için akıllı doğrulama sistemi.

Modüler Elektronik Donanım Tasarımı:

Gelecekteki bakım ihtiyaçlarınıza uyum sağlamak için esnek ve yükseltilebilir yapı.

Mutlusan Chargebox ile elektrikli aracınız için güvenli, hızlı ve kolay bir şarj deneyimi yaşayın.

Chargebox V EV Charge



Portable EV Charge



ChargeBox Smart



yakında...

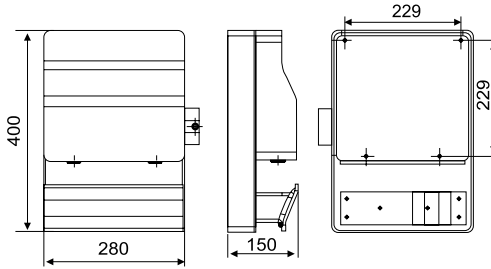
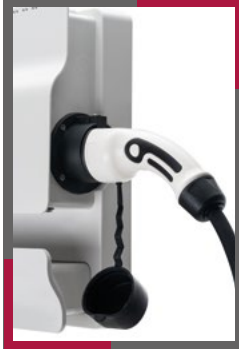
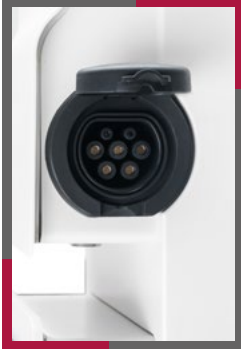

ARAÇ ŞARJ CİHAZLARI

| Ürün Kodu | Ürün Adı | Kutu Adedi | Fiyat (\$) |
|-----------|----------|------------|------------|
|-----------|----------|------------|------------|

22 kW ARAÇ ŞARJ CİHAZLARI

| | | | |
|----------------------|--|---|---------|
| 001 191 022001 00 00 | MUTLUSAN CHARGEBOX 22 KW EV CHARGER - SOKETLİ | 1 | 1800 \$ |
| 001 191 022002 00 00 | MUTLUSAN CHARGEBOX 22 KW EV CHARGER - KABLOLU | 1 | 2050 \$ |
| 001 191 022011 00 00 | MUTLUSAN CHARGEBOX 22 KW RFID EKLENTİLİ EV CHARGER - SOKETLİ | 1 | 2000 \$ |
| 001 191 022012 00 00 | MUTLUSAN CHARGEBOX 22 KW RFID EKLENTİLİ EV CHARGE - KABLOLU | 1 | 2250 \$ |

| Ürün Kodu | Ürün Adı | Kutu Adedi | Fiyat (₺) |
|-----------|----------|------------|-----------|
|-----------|----------|------------|-----------|

7 kW ARAÇ ŞARJ CİHAZLARI

| | | | |
|----------------------|---|---|---------|
| 001 191 070001 00 00 | MUTLUSAN CHARGEBOX 7 KW EV CHARGER - SOKETLİ | 1 | 1550 \$ |
| 001 191 070002 00 00 | MUTLUSAN CHARGEBOX 7 KW EV CHARGER - KABLOLU | 1 | 1750 \$ |
| 001 191 070011 00 00 | MUTLUSAN CHARGEBOX 7 KW RFID EKLENTİLİ EV CHARGER - SOKETLİ | 1 | 1750 \$ |
| 001 191 070012 00 00 | MUTLUSAN CHARGEBOX 7 KW RFID EKLENTİLİ EV CHARGER- KABLOLU | 1 | 1950 \$ |

| Ürün Kodu | Ürün Adı | Kutu Adedi | Fiyat (₺) |
|-----------|----------|------------|-----------|
|-----------|----------|------------|-----------|

3,5 kW ARAÇ ŞARJ CİHAZI - TAŞINABİLİR

| | | | |
|----------------------|---|---|--------|
| 001 191 030000 00 00 | MUTLUSAN CHARGEBOX 3.5 KW TAŞINABİLİR - TAŞINABİLİR | 1 | 850 \$ |
|----------------------|---|---|--------|

| Ürün Kodu | Ürün Adı | Kutu Adedi | Fiyat (₺) |
|-----------|----------|------------|-----------|
|-----------|----------|------------|-----------|

ŞARJ CİHAZI KABLOLU FİŞLER (5 MT)

| | | | |
|----------------|---|---|-----------|
| 999 983 000010 | MUTLUSAN CHARGEBOX 7 KW ÇİFT TARAFLI KABLOLU FİŞ | 1 | 441,49 \$ |
| 999 983 000012 | MUTLUSAN CHARGEBOX 22 KW ÇİFT TARAFLI KABLOLU FİŞ | 1 | 502,21 \$ |
| 999 983 000064 | MUTLUSAN CHARGEBOX 7 KW ÇİFT TARAFLI KABLOLU FİŞ - SİRALLI | 1 | 461,73 \$ |
| 999 983 000066 | MUTLUSAN CHARGEBOX 22 KW ÇİFT TARAFLI KABLOLU FİŞ - SİRALLI | 1 | 552,81 \$ |

| Ürün Kodu | Ürün Adı | Kutu Adedi | Fiyat (₺) |
|-----------|----------|------------|-----------|
|-----------|----------|------------|-----------|

RFID KART

| | | | |
|----------------|------------------------------|---|----------|
| 999 983 000050 | MUTLUSAN CHARGEBOX RFID KART | 1 | 20,65 \$ |
|----------------|------------------------------|---|----------|



ŞALT GRUBU

B TİPİ OTOMATİK SİGORTALAR - 6kA



MTS06 SERİSİ

| Kutup Sayısı | In (A) Anma Akımı | Ürün Kodu | Kutu Adedi | Koli Adedi | Fiyat (\$) |
|--------------|----------------------|-------------|------------|------------|------------|
| 1P | 1A | MTS06-1001B | 12 | 240 | 5,03 \$ |
| | 2A | MTS06-1002B | 12 | 240 | 5,03 \$ |
| | 3A | MTS06-1003B | 12 | 240 | 5,03 \$ |
| | 4A | MTS06-1004B | 12 | 240 | 5,03 \$ |
| | 5A | MTS06-1005B | 12 | 240 | 5,03 \$ |
| | 6A | MTS06-1006B | 12 | 240 | 4,14 \$ |
| | 10A | MTS06-1010B | 12 | 240 | 3,45 \$ |
| | 16A | MTS06-1016B | 12 | 240 | 3,45 \$ |
| | 20A | MTS06-1020B | 12 | 240 | 3,45 \$ |
| | 25A | MTS06-1025B | 12 | 240 | 3,45 \$ |
| | 32A | MTS06-1032B | 12 | 240 | 4,07 \$ |
| | 40A | MTS06-1040B | 12 | 240 | 4,81 \$ |
| | 50A | MTS06-1050B | 12 | 240 | 5,21 \$ |
| | 63A | MTS06-1063B | 12 | 240 | 5,41 \$ |
| 2P | 1A | MTS06-2001B | 6 | 120 | 10,69 \$ |
| | 2A | MTS06-2002B | 6 | 120 | 10,69 \$ |
| | 3A | MTS06-2003B | 6 | 120 | 10,69 \$ |
| | 4A | MTS06-2004B | 6 | 120 | 10,69 \$ |
| | 5A | MTS06-2005B | 6 | 120 | 10,69 \$ |
| | 6A | MTS06-2006B | 6 | 120 | 10,10 \$ |
| | 10A | MTS06-2010B | 6 | 120 | 8,72 \$ |
| | 16A | MTS06-2016B | 6 | 120 | 8,72 \$ |
| | 20A | MTS06-2020B | 6 | 120 | 8,72 \$ |
| | 25A | MTS06-2025B | 6 | 120 | 8,72 \$ |
| | 32A | MTS06-2032B | 6 | 120 | 9,97 \$ |
| | 40A | MTS06-2040B | 6 | 120 | 10,79 \$ |
| | 50A | MTS06-2050B | 6 | 120 | 11,55 \$ |
| | 63A | MTS06-2063B | 6 | 120 | 11,90 \$ |
| 3P | 1A | MTS06-3001B | 4 | 80 | 16,18 \$ |
| | 2A | MTS06-3002B | 4 | 80 | 16,18 \$ |
| | 3A | MTS06-3003B | 4 | 80 | 16,18 \$ |
| | 4A | MTS06-3004B | 4 | 80 | 16,18 \$ |
| | 5A | MTS06-3005B | 4 | 80 | 16,18 \$ |
| | 6A | MTS06-3006B | 4 | 80 | 15,55 \$ |
| | 10A | MTS06-3010B | 4 | 80 | 12,24 \$ |
| | 16A | MTS06-3016B | 4 | 80 | 12,24 \$ |
| | 20A | MTS06-3020B | 4 | 80 | 12,24 \$ |
| | 25A | MTS06-3025B | 4 | 80 | 12,24 \$ |
| | 32A | MTS06-3032B | 4 | 80 | 12,45 \$ |
| | 40A | MTS06-3040B | 4 | 80 | 12,69 \$ |
| | 50A | MTS06-3050B | 4 | 80 | 16,90 \$ |
| | 63A | MTS06-3063B | 4 | 80 | 18,28 \$ |
| 4P | 1A | MTS06-4001B | 3 | 60 | 23,05 \$ |
| | 2A | MTS06-4002B | 3 | 60 | 23,05 \$ |
| | 3A | MTS06-4003B | 3 | 60 | 23,05 \$ |
| | 4A | MTS06-4004B | 3 | 60 | 23,05 \$ |
| | 5A | MTS06-4005B | 3 | 60 | 23,05 \$ |
| | 6A | MTS06-4006B | 3 | 60 | 20,83 \$ |
| | 10A | MTS06-4010B | 3 | 60 | 16,79 \$ |
| | 16A | MTS06-4016B | 3 | 60 | 16,79 \$ |
| | 20A | MTS06-4020B | 3 | 60 | 16,79 \$ |
| | 25A | MTS06-4025B | 3 | 60 | 16,79 \$ |
| | 32A | MTS06-4032B | 3 | 60 | 17,72 \$ |
| | 40A | MTS06-4040B | 3 | 60 | 19,07 \$ |
| | 50A | MTS06-4050B | 3 | 60 | 21,79 \$ |
| | 63A | MTS06-4063B | 3 | 60 | 22,79 \$ |



TS E C E C TİPİ OTOMATİK SİGORTALAR - 6kA

MTS06 SERİSİ



| Kutup Sayısı | In (A) Anma Akımı | Ürün Kodu | Kutu Adedi | Koli Adedi | Fiyat (\$) |
|--------------|----------------------|-------------|------------|------------|------------|
| 1P | 1A | MTS06-1001C | 12 | 240 | 5,12 \$ |
| | 2A | MTS06-1002C | 12 | 240 | 5,12 \$ |
| | 3A | MTS06-1003C | 12 | 240 | 5,12 \$ |
| | 4A | MTS06-1004C | 12 | 240 | 5,12 \$ |
| | 5A | MTS06-1005C | 12 | 240 | 5,12 \$ |
| | 6A | MTS06-1006C | 12 | 240 | 4,31 \$ |
| | 10A | MTS06-1010C | 12 | 240 | 3,62 \$ |
| | 16A | MTS06-1016C | 12 | 240 | 3,62 \$ |
| | 20A | MTS06-1020C | 12 | 240 | 3,62 \$ |
| | 25A | MTS06-1025C | 12 | 240 | 3,62 \$ |
| | 32A | MTS06-1032C | 12 | 240 | 4,42 \$ |
| | 40A | MTS06-1040C | 12 | 240 | 5,17 \$ |
| | 50A | MTS06-1050C | 12 | 240 | 5,55 \$ |
| 63A | MTS06-1063C | 12 | 240 | 5,85 \$ | |
| 2P | 1A | MTS06-2001C | 6 | 120 | 13,10 \$ |
| | 2A | MTS06-2002C | 6 | 120 | 13,10 \$ |
| | 3A | MTS06-2003C | 6 | 120 | 13,10 \$ |
| | 4A | MTS06-2004C | 6 | 120 | 13,10 \$ |
| | 5A | MTS06-2005C | 6 | 120 | 13,10 \$ |
| | 6A | MTS06-2006C | 6 | 120 | 10,69 \$ |
| | 10A | MTS06-2010C | 6 | 120 | 10,69 \$ |
| | 16A | MTS06-2016C | 6 | 120 | 10,69 \$ |
| | 20A | MTS06-2020C | 6 | 120 | 10,69 \$ |
| | 25A | MTS06-2025C | 6 | 120 | 10,69 \$ |
| | 32A | MTS06-2032C | 6 | 120 | 11,72 \$ |
| | 40A | MTS06-2040C | 6 | 120 | 13,10 \$ |
| | 50A | MTS06-2050C | 6 | 120 | 18,97 \$ |
| 63A | MTS06-2063C | 6 | 120 | 19,48 \$ | |
| 3P | 1A | MTS06-3001C | 4 | 80 | 17,31 \$ |
| | 2A | MTS06-3002C | 4 | 80 | 17,31 \$ |
| | 3A | MTS06-3003C | 4 | 80 | 17,31 \$ |
| | 4A | MTS06-3004C | 4 | 80 | 17,31 \$ |
| | 5A | MTS06-3005C | 4 | 80 | 17,31 \$ |
| | 6A | MTS06-3006C | 4 | 80 | 15,55 \$ |
| | 10A | MTS06-3010C | 4 | 80 | 15,55 \$ |
| | 16A | MTS06-3016C | 4 | 80 | 15,55 \$ |
| | 20A | MTS06-3020C | 4 | 80 | 15,55 \$ |
| | 25A | MTS06-3025C | 4 | 80 | 15,55 \$ |
| | 32A | MTS06-3032C | 4 | 80 | 16,38 \$ |
| | 40A | MTS06-3040C | 4 | 80 | 17,07 \$ |
| | 50A | MTS06-3050C | 4 | 80 | 21,69 \$ |
| 63A | MTS06-3063C | 4 | 80 | 27,41 \$ | |
| 4P | 1A | MTS06-4001C | 3 | 60 | 27,69 \$ |
| | 2A | MTS06-4002C | 3 | 60 | 27,69 \$ |
| | 3A | MTS06-4003C | 3 | 60 | 27,69 \$ |
| | 4A | MTS06-4004C | 3 | 60 | 27,69 \$ |
| | 5A | MTS06-4005C | 3 | 60 | 27,69 \$ |
| | 6A | MTS06-4006C | 3 | 60 | 23,45 \$ |
| | 10A | MTS06-4010C | 3 | 60 | 22,07 \$ |
| | 16A | MTS06-4016C | 3 | 60 | 22,07 \$ |
| | 20A | MTS06-4020C | 3 | 60 | 22,07 \$ |
| | 25A | MTS06-4025C | 3 | 60 | 22,07 \$ |
| | 32A | MTS06-4032C | 3 | 60 | 25,17 \$ |
| | 40A | MTS06-4040C | 3 | 60 | 26,90 \$ |
| | 50A | MTS06-4050C | 3 | 60 | 35,41 \$ |
| 63A | MTS06-4063C | 3 | 60 | 38,34 \$ | |

C TİPİ OTOMATİK SİGORTALAR - 10kA



MTS10 SERİSİ

| Kutup Sayısı | In (A) Anma Akımı | Ürün Kodu | Kutu Adedi | Koli Adedi | Fiyat (\$) |
|--------------|----------------------|-------------|------------|------------|------------|
| 1P | 1A | MTS10-1001C | 12 | 240 | 8,62 \$ |
| | 2A | MTS10-1002C | 12 | 240 | 8,62 \$ |
| | 3A | MTS10-1003C | 12 | 240 | 8,62 \$ |
| | 4A | MTS10-1004C | 12 | 240 | 8,62 \$ |
| | 5A | MTS10-1005C | 12 | 240 | 8,62 \$ |
| | 6A | MTS10-1006C | 12 | 240 | 7,03 \$ |
| | 10A | MTS10-1010C | 12 | 240 | 6,52 \$ |
| | 16A | MTS10-1016C | 12 | 240 | 6,52 \$ |
| | 20A | MTS10-1020C | 12 | 240 | 6,52 \$ |
| | 25A | MTS10-1025C | 12 | 240 | 6,52 \$ |
| | 32A | MTS10-1032C | 12 | 240 | 6,69 \$ |
| | 40A | MTS10-1040C | 12 | 240 | 7,62 \$ |
| | 50A | MTS10-1050C | 12 | 240 | 7,93 \$ |
| | 63A | MTS10-1063C | 12 | 240 | 10,00 \$ |
| 2P | 1A | MTS10-2001C | 6 | 120 | 21,38 \$ |
| | 2A | MTS10-2002C | 6 | 120 | 21,38 \$ |
| | 3A | MTS10-2003C | 6 | 120 | 21,38 \$ |
| | 4A | MTS10-2004C | 6 | 120 | 21,38 \$ |
| | 5A | MTS10-2005C | 6 | 120 | 21,38 \$ |
| | 6A | MTS10-2006C | 6 | 120 | 21,45 \$ |
| | 10A | MTS10-2010C | 6 | 120 | 17,48 \$ |
| | 16A | MTS10-2016C | 6 | 120 | 17,48 \$ |
| | 20A | MTS10-2020C | 6 | 120 | 17,48 \$ |
| | 25A | MTS10-2025C | 6 | 120 | 17,48 \$ |
| | 32A | MTS10-2032C | 6 | 120 | 20,72 \$ |
| | 40A | MTS10-2040C | 6 | 120 | 21,10 \$ |
| | 50A | MTS10-2050C | 6 | 120 | 24,86 \$ |
| | 63A | MTS10-2063C | 6 | 120 | 25,24 \$ |
| 3P | 1A | MTS10-3001C | 4 | 80 | 28,59 \$ |
| | 2A | MTS10-3002C | 4 | 80 | 28,59 \$ |
| | 3A | MTS10-3003C | 4 | 80 | 28,59 \$ |
| | 4A | MTS10-3004C | 4 | 80 | 28,59 \$ |
| | 5A | MTS10-3005C | 4 | 80 | 28,59 \$ |
| | 6A | MTS10-3006C | 4 | 80 | 23,07 \$ |
| | 10A | MTS10-3010C | 4 | 80 | 20,72 \$ |
| | 16A | MTS10-3016C | 4 | 80 | 20,72 \$ |
| | 20A | MTS10-3020C | 4 | 80 | 20,72 \$ |
| | 25A | MTS10-3025C | 4 | 80 | 22,62 \$ |
| | 32A | MTS10-3032C | 4 | 80 | 23,24 \$ |
| | 40A | MTS10-3040C | 4 | 80 | 25,07 \$ |
| | 50A | MTS10-3050C | 4 | 80 | 25,83 \$ |
| | 63A | MTS10-3063C | 4 | 80 | 32,21 \$ |
| 4P | 1A | MTS10-4001C | 3 | 60 | 38,34 \$ |
| | 2A | MTS10-4002C | 3 | 60 | 38,34 \$ |
| | 3A | MTS10-4003C | 3 | 60 | 38,34 \$ |
| | 4A | MTS10-4004C | 3 | 60 | 38,34 \$ |
| | 5A | MTS10-4005C | 3 | 60 | 38,34 \$ |
| | 6A | MTS10-4006C | 3 | 60 | 32,34 \$ |
| | 10A | MTS10-4010C | 3 | 60 | 30,45 \$ |
| | 16A | MTS10-4016C | 3 | 60 | 30,45 \$ |
| | 20A | MTS10-4020C | 3 | 60 | 30,45 \$ |
| | 25A | MTS10-4025C | 3 | 60 | 30,79 \$ |
| | 32A | MTS10-4032C | 3 | 60 | 30,79 \$ |
| | 40A | MTS10-4040C | 3 | 60 | 31,86 \$ |
| | 50A | MTS10-4050C | 3 | 60 | 45,28 \$ |
| | 63A | MTS10-4063C | 3 | 60 | 51,62 \$ |



C TİPİ OTOMATİK SİGORTALAR - 10kA

MTS SERİSİ



| Kutup Sayısı | In (A) Anma Akımı | Ürün Kodu | Kutu Adedi | Koli Adedi | Fiyat (\$) |
|--------------|----------------------|-------------|------------|------------|------------|
| 1P | 80A | MTS10-1080C | 12 | 240 | 19,31 \$ |
| | 100A | MTS10-1100C | 12 | 240 | 19,97 \$ |
| | 125A | MTS10-1125C | 12 | 240 | 22,90 \$ |
| 2P | 80A | MTS10-2080C | 6 | 120 | 35,59 \$ |
| | 100A | MTS10-2100C | 6 | 120 | 38,41 \$ |
| | 125A | MTS10-2125C | 6 | 120 | 42,66 \$ |
| 3P | 80A | MTS10-3080C | 4 | 80 | 68,03 \$ |
| | 100A | MTS10-3100C | 4 | 80 | 70,07 \$ |
| | 125A | MTS10-3125C | 4 | 80 | 76,34 \$ |
| 4P | 80A | MTS10-4080C | 3 | 60 | 92,76 \$ |
| | 100A | MTS10-4100C | 3 | 60 | 95,93 \$ |
| | 125A | MTS10-4125C | 3 | 60 | 131,41 \$ |

OTOMATİK SİGORTA YARDIMCI KONTAKLARI

| Ürün Kodu | Ürün Adı | Kutu Adedi | Koli Adedi | Fiyat (\$) |
|-------------|-------------------------------------|------------|------------|------------|
| MTSAUX-AC12 | 1NO+1NC 160 - 250A Yardımcı Kontakt | 30 | 720 | 9,83 \$ |
| MTSAUX-DC12 | 2NO+2NC 160 - 250A Yardımcı Kontakt | 30 | 540 | 9,83 \$ |

FAZ+NÖTR SİGORTALAR - 4,5kA

MTS04-N SERİSİ



| Kutup Sayısı | In (A) Anma Akımı | Ürün Kodu | Kutu Adedi | Koli Adedi | Fiyat (\$) |
|--------------|----------------------|-------------|------------|------------|------------|
| 1P+N | 6A | MTS04-106CN | 12 | 240 | 4,69 \$ |
| | 10A | MTS04-110CN | 12 | 240 | 3,90 \$ |
| | 16A | MTS04-116CN | 12 | 240 | 3,90 \$ |
| | 20A | MTS04-120CN | 12 | 240 | 3,90 \$ |
| | 25A | MTS04-125CN | 12 | 240 | 3,90 \$ |
| | 32A | MTS04-132CN | 12 | 240 | 4,50 \$ |
| | 40A | MTS04-140CN | 12 | 240 | 5,00 \$ |

KAÇAK AKIM DEVRE KESİCİLER 6kA / AC



MRC06 SERİSİ

| Kutup Sayısı | In (A) Anma Akımı | mA | Ürün Kodu | Kutu Adedi | Koli Adedi | Fiyat (\$) |
|--------------|----------------------|---------------|---------------|--------------|------------|------------|
| 2P | 16A | 10 mA | MRC06-201016 | 1 | 100 | 26,38 \$ |
| | 25A | | MRC06-201025 | 1 | 100 | 26,90 \$ |
| | 16A | 30 mA | MRC06-203016 | 1 | 100 | 26,38 \$ |
| | 20A | | MRC06-203020 | 1 | 100 | 26,90 \$ |
| | 25A | | MRC06-203025 | 1 | 100 | 26,90 \$ |
| | 32A | | MRC06-203032 | 1 | 100 | 27,24 \$ |
| | 40A | | MRC06-203040 | 1 | 100 | 27,55 \$ |
| | 50A | | MRC06-203050 | 1 | 100 | 29,31 \$ |
| | 63A | | MRC06-203063 | 1 | 100 | 29,31 \$ |
| | 80A | | MRC06-203080 | 1 | 100 | 40,33 \$ |
| | 100A | | MRC06-2030100 | 1 | 100 | 48,28 \$ |
| | 16A | | 100 mA | MRC06-210016 | 1 | 100 |
| | 20A | MRC06-210020 | | 1 | 100 | 26,90 \$ |
| | 25A | MRC06-210025 | | 1 | 100 | 26,90 \$ |
| | 32A | MRC06-210032 | | 1 | 100 | 27,24 \$ |
| | 40A | MRC06-210040 | | 1 | 100 | 27,55 \$ |
| | 50A | MRC06-210050 | | 1 | 100 | 29,31 \$ |
| | 63A | MRC06-210063 | | 1 | 100 | 29,31 \$ |
| | 80A | MRC06-210080 | | 1 | 100 | 40,33 \$ |
| | 100A | MRC06-2100100 | | 1 | 100 | 48,28 \$ |
| | 16A | 300 mA | | MRC06-230016 | 1 | 100 |
| | 20A | | MRC06-230020 | 1 | 100 | 26,45 \$ |
| | 25A | | MRC06-230025 | 1 | 100 | 26,45 \$ |
| | 32A | | MRC06-230032 | 1 | 100 | 26,45 \$ |
| | 40A | | MRC06-230040 | 1 | 100 | 26,45 \$ |
| | 50A | | MRC06-230050 | 1 | 100 | 28,90 \$ |
| | 63A | | MRC06-230063 | 1 | 100 | 29,38 \$ |
| 80A | MRC06-230080 | | 1 | 100 | 39,62 \$ | |
| 100A | MRC06-2300100 | | 1 | 100 | 44,49 \$ | |
| 4P | 16A | | 30 mA | MRC06-403016 | 1 | 50 |
| | 20A | MRC06-403020 | | 1 | 50 | 36,17 \$ |
| | 25A | MRC06-403025 | | 1 | 50 | 36,17 \$ |
| | 32A | MRC06-403032 | | 1 | 50 | 36,86 \$ |
| | 40A | MRC06-403040 | | 1 | 50 | 37,90 \$ |
| | 50A | MRC06-403050 | | 1 | 50 | 37,90 \$ |
| | 63A | MRC06-403063 | | 1 | 50 | 39,72 \$ |
| | 80A | MRC06-403080 | | 1 | 50 | 41,21 \$ |
| | 100A | MRC06-4030100 | | 1 | 50 | 44,83 \$ |
| | 16A | 100 mA | | MRC06-410016 | 1 | 50 |
| | 20A | | MRC06-410020 | 1 | 50 | 36,17 \$ |
| | 25A | | MRC06-410025 | 1 | 50 | 36,17 \$ |
| | 32A | | MRC06-410032 | 1 | 50 | 36,86 \$ |
| | 40A | | MRC06-410040 | 1 | 50 | 37,90 \$ |
| | 50A | | MRC06-410050 | 1 | 50 | 37,90 \$ |
| | 63A | | MRC06-410063 | 1 | 50 | 39,72 \$ |
| | 80A | | MRC06-410080 | 1 | 50 | 41,21 \$ |
| | 100A | | MRC06-4100100 | 1 | 50 | 44,83 \$ |
| | 16A | | 300 mA | MRC06-430016 | 1 | 50 |
| | 20A | MRC06-430020 | | 1 | 50 | 34,55 \$ |
| | 25A | MRC06-430025 | | 1 | 50 | 34,55 \$ |
| | 32A | MRC06-430032 | | 1 | 50 | 34,55 \$ |
| | 40A | MRC06-430040 | | 1 | 50 | 36,45 \$ |
| | 50A | MRC06-430050 | | 1 | 50 | 38,14 \$ |
| | 63A | MRC06-430063 | | 1 | 50 | 40,38 \$ |
| | 80A | MRC06-430080 | | 1 | 50 | 57,67 \$ |
| | 100A | MRC06-4300100 | | 1 | 50 | 64,83 \$ |



KAÇAK AKIM KORUMALI SİĞORTALAR 6kA

MRCO06 SERİSİ



| Kutup Sayısı | In (A) Anma Akımı | mA | Tipi | Ürün Kodu | Kutu Adedi | Koli Adedi | Fiyat (\$) | | |
|--------------|----------------------|-----------------|----------------|-----------------|----------------|-----------------|------------|----------|----------|
| 2P | 6A | 10 mA | AC Tipi | MRCO06-201006AC | 1 | 30 | 43,48 \$ | | |
| | 16A | | | MRCO06-201016AC | 1 | 30 | 43,48 \$ | | |
| | 20A | | | MRCO06-201020AC | 1 | 30 | 43,48 \$ | | |
| | 25A | | | MRCO06-201025AC | 1 | 30 | 43,48 \$ | | |
| | 6A | 10 mA | A Tipi | MRCO06-201006A | 1 | 30 | 52,64 \$ | | |
| | 16A | | | MRCO06-201016A | 1 | 30 | 52,64 \$ | | |
| | 20A | | | MRCO06-201020A | 1 | 30 | 52,64 \$ | | |
| | 25A | | | MRCO06-201025A | 1 | 30 | 52,64 \$ | | |
| | 6A | 30 mA | AC Tipi | MRCO06-203006AC | 1 | 30 | 40,97 \$ | | |
| | 16A | | | MRCO06-203016AC | 1 | 30 | 40,97 \$ | | |
| | 20A | | | MRCO06-203020AC | 1 | 30 | 40,97 \$ | | |
| | 25A | | | MRCO06-203025AC | 1 | 30 | 40,97 \$ | | |
| | 32A | | | MRCO06-203032AC | 1 | 30 | 44,10 \$ | | |
| | 40A | | | MRCO06-203040AC | 1 | 30 | 44,10 \$ | | |
| | 6A | 30 mA | AC Tipi | MRCO06-203063AC | 1 | 30 | 49,78 \$ | | |
| | 6A | | | 100 mA | AC Tipi | MRCO06-210006AC | 1 | 30 | 43,37 \$ |
| | 16A | | | | | MRCO06-210016AC | 1 | 30 | 43,37 \$ |
| | 20A | | | | | MRCO06-210020AC | 1 | 30 | 43,37 \$ |
| | 25A | | | | | MRCO06-210025AC | 1 | 30 | 43,37 \$ |
| | 32A | | | | | MRCO06-210032AC | 1 | 30 | 43,37 \$ |
| | 40A | MRCO06-210040AC | 1 | | | 30 | 43,37 \$ | | |
| | 6A | 300 mA | AC Tipi | MRCO06-210063AC | 1 | 30 | 54,93 \$ | | |
| | 6A | | | 30 mA | AC Tipi | MRCO06-230006AC | 1 | 30 | 38,56 \$ |
| | 16A | | | | | MRCO06-230016AC | 1 | 30 | 38,56 \$ |
| | 20A | | | | | MRCO06-230020AC | 1 | 30 | 38,56 \$ |
| | 25A | | | | | MRCO06-230025AC | 1 | 30 | 38,56 \$ |
| | 32A | | | | | MRCO06-230032AC | 1 | 30 | 41,06 \$ |
| | 40A | MRCO06-230040AC | 1 | | | 30 | 41,06 \$ | | |
| | 6A | 30 mA | AC Tipi | MRCO06-230063AC | 1 | 30 | 51,49 \$ | | |
| | 6A | | | 100 mA | A Tipi | MRCO06-230006A | 1 | 30 | 50,47 \$ |
| | 16A | | | | | MRCO06-230016A | 1 | 30 | 50,47 \$ |
| | 20A | | | | | MRCO06-230020A | 1 | 30 | 50,47 \$ |
| | 25A | | | | | MRCO06-230025A | 1 | 30 | 50,47 \$ |
| | 32A | | | | | MRCO06-230032A | 1 | 30 | 50,47 \$ |
| | 40A | MRCO06-230040A | 1 | | | 30 | 50,47 \$ | | |
| | 6A | 30 mA | AC Tipi | MRCO06-230063A | 1 | 30 | 61,31 \$ | | |
| | 6A | | | 100 mA | A Tipi | MRCO06-210006A | 1 | 30 | 50,47 \$ |
| | 16A | | | | | MRCO06-210016A | 1 | 30 | 50,47 \$ |
| | 20A | | | | | MRCO06-210020A | 1 | 30 | 50,47 \$ |
| | 25A | | | | | MRCO06-210025A | 1 | 30 | 50,47 \$ |
| | 32A | | | | | MRCO06-210032A | 1 | 30 | 50,47 \$ |
| | 40A | MRCO06-210040A | 1 | | | 30 | 50,47 \$ | | |
| 6A | 300 mA | A Tipi | MRCO06-210063A | 1 | 30 | 61,31 \$ | | | |
| 6A | | | 30 mA | A Tipi | MRCO06-230006A | 1 | 30 | 50,47 \$ | |
| 16A | | | | | MRCO06-230016A | 1 | 30 | 50,47 \$ | |
| 20A | | | | | MRCO06-230020A | 1 | 30 | 50,47 \$ | |
| 25A | | | | | MRCO06-230025A | 1 | 30 | 50,47 \$ | |
| 32A | | | | | MRCO06-230032A | 1 | 30 | 50,47 \$ | |
| 40A | MRCO06-230040A | 1 | | | 30 | 50,47 \$ | | | |
| 6A | 300 mA | A Tipi | MRCO06-230063A | 1 | 30 | 61,31 \$ | | | |

KAÇAK AKIM KORUMALI SİĞORTALAR 6kA

| Kutup Sayısı | In (A) Anma Akımı | mA | Tipi | Ürün Kodu | 1Kutu Adedi | Koli Adedi | Fiyat (\$) |
|--------------|----------------------|-----------|----------------|-----------------|-------------|------------|------------|
| 4P | 6A | 30 mA | AC Tipi | MRC006-403006AC | 1 | 60 | 66,53 \$ |
| | 16A | | | MRC006-403016AC | 1 | 60 | 66,53 \$ |
| | 20A | | | MRC006-403020AC | 1 | 60 | 66,53 \$ |
| | 25A | | | MRC006-403025AC | 1 | 60 | 66,53 \$ |
| | 32A | | | MRC006-403032AC | 1 | 60 | 68,69 \$ |
| | 40A | | | MRC006-403040AC | 1 | 60 | 68,69 \$ |
| | 63A | | | MRC006-403063AC | 1 | 60 | 90,19 \$ |
| | 6A | 100 mA | AC Tipi | MRC006-410006AC | 1 | 60 | 69,03 \$ |
| | 16A | | | MRC006-410016AC | 1 | 60 | 69,03 \$ |
| | 20A | | | MRC006-410020AC | 1 | 60 | 69,03 \$ |
| | 25A | | | MRC006-410025AC | 1 | 60 | 69,03 \$ |
| | 32A | | | MRC006-410032AC | 1 | 60 | 69,03 \$ |
| | 40A | | | MRC006-410040AC | 1 | 60 | 69,03 \$ |
| | 63A | | | MRC006-410063AC | 1 | 60 | 90,19 \$ |
| | 6A | 300 mA | AC Tipi | MRC006-430006AC | 1 | 60 | 64,27 \$ |
| | 16A | | | MRC006-430016AC | 1 | 60 | 64,27 \$ |
| | 20A | | | MRC006-430020AC | 1 | 60 | 64,27 \$ |
| | 25A | | | MRC006-430025AC | 1 | 60 | 64,27 \$ |
| | 32A | | | MRC006-430032AC | 1 | 60 | 66,53 \$ |
| | 40A | | | MRC006-430040AC | 1 | 60 | 66,53 \$ |
| | 63A | | | MRC006-430063AC | 1 | 60 | 90,19 \$ |
| | 6A | 30mA | A Tipi | MRC006-403006A | 1 | 60 | 76,88 \$ |
| | 16A | | | MRC006-403016A | 1 | 60 | 76,88 \$ |
| | 20A | | | MRC006-403020A | 1 | 60 | 76,88 \$ |
| 25A | MRC006-403025A | | | 1 | 60 | 76,88 \$ | |
| 32A | MRC006-403032A | | | 1 | 60 | 76,88 \$ | |
| 40A | MRC006-403040A | | | 1 | 60 | 76,88 \$ | |
| 63A | MRC006-403063A | | | 1 | 60 | 98,04 \$ | |
| 6A | 100 mA | A Tipi | MRC006-410006A | 1 | 60 | 76,88 \$ | |
| 16A | | | MRC006-410016A | 1 | 60 | 76,88 \$ | |
| 20A | | | MRC006-410020A | 1 | 60 | 76,88 \$ | |
| 25A | | | MRC006-410025A | 1 | 60 | 76,88 \$ | |
| 32A | | | MRC006-410032A | 1 | 60 | 76,88 \$ | |
| 40A | | | MRC006-410040A | 1 | 60 | 76,88 \$ | |
| 63A | | | MRC006-410063A | 1 | 60 | 98,04 \$ | |
| 6A | 300 mA | A Tipi | MRC006-430006A | 1 | 60 | 76,88 \$ | |
| 16A | | | MRC006-430016A | 1 | 60 | 76,88 \$ | |
| 20A | | | MRC006-430020A | 1 | 60 | 76,88 \$ | |
| 25A | | | MRC006-430025A | 1 | 60 | 76,88 \$ | |
| 32A | | | MRC006-430032A | 1 | 60 | 76,88 \$ | |
| 40A | | | MRC006-430040A | 1 | 60 | 76,88 \$ | |
| 63A | | | MRC006-430063A | 1 | 60 | 98,04 \$ | |

MRC006 SERİSİ



KOMPAKT TİP DEVRE KESİCİLER - TERMİK MANYETİK - SABİT TİP

MTF SERİSİ



| Kutup Sayısı | In (A) Anma Akımı | kA | Ürün Kodu | Kutu Adedi | Koli Adedi | Fiyat (\$) |
|--------------|----------------------|-------------|------------|------------|------------|------------|
| 2P | 40A | 18 kA | MTF18-2040 | 1 | 36 | 76,48 \$ |
| | 63A | | MTF18-2063 | 1 | 36 | 79,66 \$ |
| | 100A | | MTF18-2100 | 1 | 36 | 79,66 \$ |
| | 125A | | MTF18-2125 | 1 | 36 | 79,66 \$ |
| | 160A | | MTF18-2160 | 1 | 36 | 82,90 \$ |
| 3P | 16A | 22 kA | MTF22-3016 | 1 | 24 | 82,65 \$ |
| | 40A | | MTF22-3040 | 1 | 24 | 82,65 \$ |
| | 63A | | MTF22-3063 | 1 | 24 | 86,62 \$ |
| | 100A | | MTF22-3100 | 1 | 24 | 86,62 \$ |
| | 125A | | MTF22-3125 | 1 | 24 | 86,62 \$ |
| | 160A | MTF22-3160 | 1 | 24 | 90,65 \$ | |
| | 16A | 25 kA | MTF25-3016 | 1 | 24 | 84,48 \$ |
| | 25A | | MTF25-3025 | 1 | 24 | 84,48 \$ |
| | 32A | | MTF25-3032 | 1 | 24 | 84,48 \$ |
| | 40A | | MTF25-3040 | 1 | 24 | 84,48 \$ |
| | 50A | | MTF25-3050 | 1 | 24 | 84,48 \$ |
| | 63A | | MTF25-3063 | 1 | 24 | 84,48 \$ |
| | 80A | | MTF25-3080 | 1 | 24 | 84,48 \$ |
| | 100A | | MTF25-3100 | 1 | 24 | 91,10 \$ |
| | 125A | | MTF25-3125 | 1 | 24 | 91,10 \$ |
| | 160A | | MTF25-3160 | 1 | 24 | 91,10 \$ |
| | 100A | 35 kA | MTF35-3100 | 1 | 16 | 138,46 \$ |
| | 125A | | MTF35-3125 | 1 | 16 | 138,46 \$ |
| | 160A | | MTF35-3160 | 1 | 16 | 138,46 \$ |
| | 200A | | MTF35-3200 | 1 | 16 | 138,46 \$ |
| | 250A | | MTF35-3250 | 1 | 16 | 138,46 \$ |
| | 100A | 42 kA | MTF42-3100 | 1 | 16 | 161,11 \$ |
| | 125A | | MTF42-3125 | 1 | 16 | 161,11 \$ |
| | 160A | | MTF42-3160 | 1 | 16 | 161,11 \$ |
| | 200A | | MTF42-3200 | 1 | 16 | 161,11 \$ |
| 250A | MTF42-3250 | | 1 | 16 | 161,11 \$ | |
| 315A | 50 kA | MTF50-30315 | 1 | 4 | 275,86 \$ | |
| 400A | | MTF50-30400 | 1 | 4 | 310,34 \$ | |
| 500A | | MTF50-30500 | 1 | 2 | 344,83 \$ | |
| 630A | | MTF50-30630 | 1 | 2 | 385,14 \$ | |
| 800A | | MTF50-30800 | 1 | 2 | 898,66 \$ | |
| 4P | 16A | 22 kA | MTF22-4016 | 1 | 18 | 103,87 \$ |
| | 40A | | MTF22-4040 | 1 | 18 | 103,87 \$ |
| | 63A | | MTF22-4063 | 1 | 18 | 111,81 \$ |
| | 100A | | MTF22-4100 | 1 | 18 | 111,81 \$ |
| | 125A | | MTF22-4125 | 1 | 18 | 111,81 \$ |
| | 160A | MTF22-4160 | 1 | 18 | 113,79 \$ | |
| | 16A | 25 kA | MTF25-4016 | 1 | 18 | 119,66 \$ |
| | 25A | | MTF25-4025 | 1 | 18 | 119,66 \$ |
| | 32A | | MTF25-4032 | 1 | 18 | 119,66 \$ |
| | 40A | | MTF25-4040 | 1 | 18 | 119,66 \$ |
| | 63A | | MTF25-4063 | 1 | 18 | 119,66 \$ |
| | 80A | | MTF25-4080 | 1 | 18 | 125,52 \$ |
| | 100A | | MTF25-4100 | 1 | 18 | 129,13 \$ |
| | 125A | | MTF25-4125 | 1 | 18 | 134,44 \$ |
| | 160A | | MTF25-4160 | 1 | 18 | 140,16 \$ |
| | 100A | | 35 kA | MTF35-4100 | 1 | 12 |
| | 125A | MTF35-4125 | | 1 | 12 | 184,56 \$ |
| | 160A | MTF35-4160 | | 1 | 12 | 184,56 \$ |
| | 200A | MTF35-4200 | | 1 | 12 | 184,56 \$ |
| | 250A | MTF35-4250 | | 1 | 12 | 184,56 \$ |
| | 100A | 42 kA | MTF42-4100 | 1 | 12 | 197,51 \$ |
| | 125A | | MTF42-4125 | 1 | 12 | 197,51 \$ |
| | 160A | | MTF42-4160 | 1 | 12 | 197,51 \$ |
| | 200A | | MTF42-4200 | 1 | 12 | 197,51 \$ |
| | 250A | | MTF42-4250 | 1 | 12 | 197,51 \$ |
| 315A | 50 kA | MTF50-40315 | 1 | 3 | 482,76 \$ | |
| 400A | | MTF50-40400 | 1 | 3 | 517,24 \$ | |
| 500A | | MTF50-40500 | 1 | 2 | 641,90 \$ | |
| 630A | | MTF50-40630 | 1 | 2 | 672,41 \$ | |
| 800A | | MTF50-40800 | 1 | 2 | 1034,48 \$ | |

KOMPAKT TİP DEVRE KESİCİLER - TERMİK MANYETİK - AYAR SAHALI

| Kutup Sayısı | In (A) Anma Akımı | kA | Ürün Kodu | Kutu Adedi | Koli Adedi | Fiyat (\$) |
|--------------|----------------------|------------|-------------|------------|------------|------------|
| 2P | 40A | 18 kA | MTA18-2040 | 1 | 36 | 115,44 \$ |
| | 63A | | MTA18-2063 | 1 | 36 | 120,26 \$ |
| | 100A | | MTA18-2100 | 1 | 36 | 123,28 \$ |
| | 125A | | MTA18-2125 | 1 | 36 | 127,56 \$ |
| | 160A | | MTA18-2160 | 1 | 36 | 136,62 \$ |
| 3P | 16A | 22 kA | MTA22-3016 | 1 | 24 | 140,87 \$ |
| | 40A | | MTA22-3040 | 1 | 24 | 143,69 \$ |
| | 63A | | MTA22-3063 | 1 | 24 | 150,73 \$ |
| | 100A | | MTA22-3100 | 1 | 24 | 151,61 \$ |
| | 125A | | MTA22-3125 | 1 | 24 | 152,52 \$ |
| | 160A | | MTA22-3160 | 1 | 24 | 157,77 \$ |
| | 16A | 25 kA | MTA25-3016 | 1 | 24 | 170,01 \$ |
| | 25A | | MTA25-3025 | 1 | 24 | 170,01 \$ |
| | 32A | | MTA25-3032 | 1 | 24 | 170,01 \$ |
| | 40A | | MTA25-3040 | 1 | 24 | 174,87 \$ |
| | 50A | | MTA25-3050 | 1 | 24 | 174,86 \$ |
| | 63A | | MTA25-3063 | 1 | 24 | 187,13 \$ |
| | 80A | | MTA25-3080 | 1 | 24 | 187,13 \$ |
| | 100A | | MTA25-3100 | 1 | 24 | 193,59 \$ |
| | 125A | | MTA25-3125 | 1 | 24 | 199,35 \$ |
| | 160A | | MTA25-3160 | 1 | 24 | 204,83 \$ |
| | 100A | 35 kA | MTA35-3100 | 1 | 16 | 122,03 \$ |
| | 125A | | MTA35-3125 | 1 | 16 | 155,26 \$ |
| | 160A | | MTA35-3160 | 1 | 16 | 161,47 \$ |
| | 200A | | MTA35-3200 | 1 | 16 | 196,69 \$ |
| | 250A | | MTA35-3250 | 1 | 16 | 205,90 \$ |
| | 100A | 42 kA | MTA42-3100 | 1 | 16 | 150,00 \$ |
| | 125A | | MTA42-3125 | 1 | 16 | 153,79 \$ |
| | 160A | | MTA42-3160 | 1 | 16 | 157,48 \$ |
| | 200A | | MTA42-3200 | 1 | 16 | 188,14 \$ |
| | 250A | | MTA42-3250 | 1 | 16 | 195,86 \$ |
| | 315A | 50 kA | MTA50-30315 | 1 | 4 | 379,31 \$ |
| | 400A | | MTA50-30400 | 1 | 4 | 518,07 \$ |
| | 630A | | MTA50-30630 | 1 | 2 | 631,59 \$ |
| 800A | MTA50-30800 | | 1 | 2 | 800,24 \$ | |
| 4P | 16A | 22 kA | MTA22-4016 | 1 | 18 | 189,59 \$ |
| | 40A | | MTA22-4040 | 1 | 18 | 193,33 \$ |
| | 63A | | MTA22-4063 | 1 | 18 | 199,45 \$ |
| | 100A | | MTA22-4100 | 1 | 18 | 202,40 \$ |
| | 125A | | MTA22-4125 | 1 | 18 | 206,14 \$ |
| | 160A | | MTA22-4160 | 1 | 18 | 208,24 \$ |
| | 16A | 25 kA | MTA25-4016 | 1 | 18 | 213,89 \$ |
| | 25A | | MTA25-4025 | 1 | 18 | 213,89 \$ |
| | 32A | | MTA25-4032 | 1 | 18 | 213,89 \$ |
| | 40A | | MTA25-4040 | 1 | 18 | 219,61 \$ |
| | 63A | | MTA25-4063 | 1 | 18 | 229,03 \$ |
| | 80A | | MTA25-4080 | 1 | 18 | 235,03 \$ |
| | 100A | | MTA25-4100 | 1 | 18 | 235,03 \$ |
| | 125A | | MTA25-4125 | 1 | 18 | 239,53 \$ |
| | 160A | | MTA25-4160 | 1 | 18 | 246,97 \$ |
| | 100A | | 35 kA | MTA35-4100 | 1 | 12 |
| | 125A | MTA35-4125 | | 1 | 12 | 255,34 \$ |
| | 160A | MTA35-4160 | | 1 | 12 | 273,06 \$ |
| | 200A | MTA35-4200 | | 1 | 12 | 320,31 \$ |
| | 250A | MTA35-4250 | | 1 | 12 | 343,91 \$ |
| | 100A | 42 kA | MTA42-4100 | 1 | 12 | 221,17 \$ |
| | 125A | | MTA42-4125 | 1 | 12 | 247,59 \$ |
| | 160A | | MTA42-4160 | 1 | 12 | 307,48 \$ |
| | 200A | | MTA42-4200 | 1 | 12 | 332,59 \$ |
| | 250A | | MTA42-4250 | 1 | 12 | 355,66 \$ |
| | 315A | 50 kA | MTA50-40315 | 1 | 3 | 724,14 \$ |
| | 400A | | MTA50-40400 | 1 | 3 | 760,69 \$ |
| | 630A | | MTA50-40630 | 1 | 2 | 840,00 \$ |
| | 800A | | MTA50-40800 | 1 | 2 | 1614,52 \$ |

MTA SERİSİ



KOMPAKT TİP DEVRE KESİCİLER - TERMİK MANYETİK - KAÇAK AKIMLI

MTL SERİSİ



| Kutup Sayısı | In (A) Anma Akımı | kA | Ürün Kodu | Kutu Adedi | Koli Adedi | Fiyat (\$) |
|--------------|----------------------|-------------|-------------|------------|------------|------------|
| 2P | 40A | 18 kA | MTL18-2025 | 1 | 36 | 258,62 \$ |
| | 63A | | MTL18-2040 | 1 | 36 | 265,52 \$ |
| | 100A | | MTL18-2063 | 1 | 36 | 276,59 \$ |
| | 125A | | MTL18-2100 | 1 | 36 | 283,53 \$ |
| | 160A | | MTL18-2125 | 1 | 36 | 293,39 \$ |
| 3P | 16A | 22 kA | MTL22-3016 | 1 | 20 | 312,36 \$ |
| | 40A | | MTL22-3040 | 1 | 20 | 316,55 \$ |
| | 63A | | MTL22-3063 | 1 | 20 | 324,17 \$ |
| | 100A | | MTL22-3100 | 1 | 20 | 326,98 \$ |
| | 125A | | MTL22-3125 | 1 | 20 | 331,48 \$ |
| | 16A | 25 kA | MTL25-3016 | 1 | 20 | 288,91 \$ |
| | 25A | | MTL25-3025 | 1 | 20 | 288,91 \$ |
| | 32A | | MTL25-3032 | 1 | 20 | 288,91 \$ |
| | 40A | | MTL25-3040 | 1 | 20 | 300,71 \$ |
| | 50A | | MTL25-3050 | 1 | 20 | 310,30 \$ |
| | 63A | | MTL25-3063 | 1 | 20 | 310,30 \$ |
| | 80A | | MTL25-3080 | 1 | 20 | 317,99 \$ |
| | 100A | | MTL25-3100 | 1 | 20 | 317,99 \$ |
| | 125A | | MTL25-3125 | 1 | 20 | 327,33 \$ |
| | 100A | | 35 kA | MTL35-3100 | 1 | 10 |
| | 125A | MTL35-3125 | | 1 | 10 | 247,59 \$ |
| | 160A | MTL35-3160 | | 1 | 10 | 258,97 \$ |
| | 200A | MTL35-3200 | | 1 | 10 | 319,52 \$ |
| | 250A | MTL35-3250 | | 1 | 10 | 338,34 \$ |
| | 100A | 42 kA | MTL42-3100 | 1 | 10 | 344,58 \$ |
| | 125A | | MTL42-3125 | 1 | 10 | 379,04 \$ |
| | 160A | | MTL42-3160 | 1 | 10 | 396,27 \$ |
| | 200A | | MTL42-3200 | 1 | 10 | 413,49 \$ |
| | 250A | | MTL42-3250 | 1 | 10 | 430,72 \$ |
| | 315A | 50 kA | MTL50-30315 | 1 | 4 | 694,32 \$ |
| 400A | MTL50-30400 | | 1 | 4 | 694,32 \$ | |
| 630A | MTL50-30630 | | 1 | 2 | 715,55 \$ | |
| 800A | MTL50-30800 | | 1 | 2 | 1373,60 \$ | |
| 4P | 16A | 22 kA | MTL22-4016 | 1 | 16 | 344,65 \$ |
| | 40A | | MTL22-4025 | 1 | 16 | 360,91 \$ |
| | 63A | | MTL22-4040 | 1 | 16 | 360,91 \$ |
| | 100A | | MTL22-4063 | 1 | 16 | 366,28 \$ |
| | 125A | | MTL22-4100 | 1 | 16 | 373,76 \$ |
| | 160A | MTL22-4125 | 1 | 16 | 380,01 \$ | |
| | 16A | 25 kA | MTL25-4016 | 1 | 16 | 348,83 \$ |
| | 25A | | MTL25-4025 | 1 | 16 | 351,72 \$ |
| | 32A | | MTL25-4032 | 1 | 16 | 351,72 \$ |
| | 40A | | MTL25-4040 | 1 | 16 | 359,50 \$ |
| | 63A | | MTL25-4050 | 1 | 16 | 373,69 \$ |
| | 80A | | MTL25-4063 | 1 | 16 | 373,69 \$ |
| | 100A | | MTL25-4080 | 1 | 16 | 381,28 \$ |
| | 125A | | MTL25-4100 | 1 | 16 | 381,28 \$ |
| | 160A | | MTL25-4125 | 1 | 16 | 389,00 \$ |
| | 100A | | 35 kA | MTL35-4100 | 1 | 8 |
| | 125A | MTL35-4125 | | 1 | 8 | 284,45 \$ |
| | 160A | MTL35-4160 | | 1 | 8 | 300,37 \$ |
| | 200A | MTL35-4200 | | 1 | 8 | 372,54 \$ |
| | 250A | MTL35-4250 | | 1 | 8 | 391,65 \$ |
| | 100A | 42 kA | MTL42-4100 | 1 | 8 | 371,09 \$ |
| | 125A | | MTL42-4125 | 1 | 8 | 408,20 \$ |
| | 160A | | MTL42-4160 | 1 | 8 | 426,75 \$ |
| | 200A | | MTL42-4200 | 1 | 8 | 445,31 \$ |
| | 250A | | MTL42-4250 | 1 | 8 | 463,86 \$ |
| 315A | 50 kA | MTL50-40315 | 1 | 3 | 874,75 \$ | |
| 400A | | MTL50-40400 | 1 | 3 | 874,75 \$ | |
| 630A | | MTL50-40630 | 1 | 2 | 902,17 \$ | |
| 800A | | MTL50-40800 | 1 | 2 | 1739,78 \$ | |

KOMPAKT TİP DEVRE KESİCİLER - TERMİK MANYETİK AKSESUARLARI

| Ürün Kodu | Ürün Adı | Kutu Adedi | Koli Adedi | Fiyat (\$) |
|--------------|-------------------------------------|------------|------------|------------|
| MTAUX-11250 | 1NO+1NC 160 - 250A Yardımcı Kontakt | 30 | 720 | 23,62 \$ |
| MTAUX-22250 | 2NO+2NC 160 - 250A Yardımcı Kontakt | 30 | 540 | 38,48 \$ |
| MTALR-00160 | 160A Alarm Kontakt | 30 | 720 | 25,64 \$ |
| MTALR-00250 | 250A Alarm Kontakt | 30 | 540 | 25,64 \$ |
| MTSHT-230160 | 230V Şant Trip Bobini 160 A | 30 | 720 | 64,73 \$ |
| MTSHT-230250 | 230V Şant Trip Bobini 250 A | 30 | 540 | 66,69 \$ |

DARBE AKIM RÖLESİ

| Kontakt | In (A) Anma Akımı | Ürün Kodu | Kutu Adedi | Koli Adedi | Fiyat (\$) |
|---------|-------------------|--------------|------------|------------|------------|
| 1NO | 16A | MIR00-123016 | 1 | 120 | 23,97 \$ |
| 2NO | 16A | MIR00-223016 | 1 | 120 | 23,97 \$ |

ANALOG ZAMAN SAATİ

| Ürün Kodu | Ürün Adı | Kutu Adedi | Koli Adedi | Fiyat (\$) |
|-----------|-----------------------------|------------|------------|------------|
| MATRO-100 | 100 Saat Analog Zaman Saati | 1 | 100 | 23,45 \$ |

TOROİD AKIM TRAFOLARI

| Ölçüsü | Ürün Kodu | Kutu Adedi | Koli Adedi | Fiyat (\$) |
|--------|-----------|------------|------------|------------|
| 40 mm | MTC00-040 | 1 | 100 | 33,02 \$ |
| 80 mm | MTC00-080 | 1 | 60 | 39,00 \$ |
| 120 mm | MTC00-120 | 1 | 60 | 55,47 \$ |
| 160 mm | MTC00-160 | 1 | 30 | 101,59 \$ |
| 210 mm | MTC00-210 | 1 | 28 | 150,75 \$ |

KAÇAK AKIM ALGILAMA RÖLESİ

| Ürün Kodu | Ürün Adı | Kutu Adedi | Koli Adedi | Fiyat (\$) |
|-----------|----------------------------|------------|------------|------------|
| MELR00-01 | Kaçak Akım Algılama Rölesi | 1 | 36 | 119,28 \$ |

MIR00 SERİSİ



MATRO SERİSİ



MTC00 SERİSİ



AÇIK TİP DEVRE KESİCİLER - SABİT TİP

MTACF SERİSİ



| Kutup Sayısı | In (A) Anma Akımı | kA | Ürün Kodu | Kutu Adedi | Koli Adedi | Fiyat (\$) |
|--------------|----------------------|----------------|----------------|------------|--------------|--------------|
| 3P | 1000A | 65 kA | MTACF3-0651000 | 1 | 1 | 2.602,73 \$ |
| | 1250A | | MTACF3-0651250 | 1 | 1 | 2.825,43 \$ |
| | 1600A | | MTACF3-0651600 | 1 | 1 | 3.106,23 \$ |
| | 2000A | | MTACF3-0652000 | 1 | 1 | 3.660,08 \$ |
| | 2500A | | MTACF3-0652500 | 1 | 1 | 4.676,77 \$ |
| | 3200A | | MTACF3-0653200 | 1 | 1 | 5.490,12 \$ |
| | 4000A | 120 kA | MTACF3-1204000 | 1 | 1 | 13.460,06 \$ |
| | 5000A | | MTACF3-1205000 | 1 | 1 | 23.981,12 \$ |
| | 6300A | MTACF3-1206300 | 1 | 1 | 27.070,22 \$ | |
| 4P | 1000A | 65 kA | MTACF4-0651000 | 1 | 1 | 3.863,42 \$ |
| | 1250A | | MTACF4-0651250 | 1 | 1 | 4.066,76 \$ |
| | 1600A | | MTACF4-0651600 | 1 | 1 | 4.371,77 \$ |
| | 2000A | | MTACF4-0652000 | 1 | 1 | 4.575,10 \$ |
| | 2500A | | MTACF4-0652500 | 1 | 1 | 5.896,80 \$ |
| | 3200A | | MTACF4-0653200 | 1 | 1 | 6.913,49 \$ |
| | 4000A | 120 kA | MTACF4-1204000 | 1 | 1 | 17.535,66 \$ |
| | 5000A | | MTACF4-1205000 | 1 | 1 | 22.602,58 \$ |
| | 6300A | | MTACF4-1206300 | 1 | 1 | 24.581,42 \$ |

AÇIK TİP DEVRE KESİCİLER - ÇEKMECELİ TİP

MTACD SERİSİ



| Kutup Sayısı | In (A) Anma Akımı | kA | Ürün Kodu | Kutu Adedi | Koli Adedi | Fiyat (\$) |
|--------------|----------------------|----------------|----------------|------------|--------------|--------------|
| 3P | 1000A | 65 kA | MTACD3-0651000 | 1 | 1 | 3.290,45 \$ |
| | 1250A | | MTACD3-0651250 | 1 | 1 | 3.290,45 \$ |
| | 1600A | | MTACD3-0651600 | 1 | 1 | 3.718,18 \$ |
| | 2000A | | MTACD3-0652000 | 1 | 1 | 4.447,29 \$ |
| | 2500A | | MTACD3-0652500 | 1 | 1 | 5.694,43 \$ |
| | 3200A | | MTACD3-0653200 | 1 | 1 | 6.470,99 \$ |
| | 4000A | 120 kA | MTACD3-1204000 | 1 | 1 | 15.229,97 \$ |
| | 5000A | | MTACD3-1205000 | 1 | 1 | 18.301,38 \$ |
| | 6300A | MTACD3-1206300 | 1 | 1 | 25.574,26 \$ | |
| 4P | 1000A | 65 kA | MTACD4-0651000 | 1 | 1 | 6.011,83 \$ |
| | 1250A | | MTACD4-0651250 | 1 | 1 | 5.806,42 \$ |
| | 1600A | | MTACD4-0651600 | 1 | 1 | 5.806,42 \$ |
| | 2000A | | MTACD4-0652000 | 1 | 1 | 6.949,90 \$ |
| | 2500A | | MTACD4-0652500 | 1 | 1 | 9.770,94 \$ |
| | 3200A | | MTACD4-0653200 | 1 | 1 | 10.380,34 \$ |
| | 4000A | 120 kA | MTACD4-1204000 | 1 | 1 | 13.504,07 \$ |
| | 5000A | | MTACD4-1205000 | 1 | 1 | 24.759,45 \$ |
| | 6300A | | MTACD4-1206300 | 1 | 1 | 26.793,06 \$ |

AC KONTAKTÖRLER - 230V AC

| Kutup Sayısı | In (A) Anma Akımı | kW | Kontakt | Voltaj (V) | Ürün Kodu | Kutu Adedi | Koli Adedi | Fiyat (\$) |
|--------------|----------------------|--------|---------|------------|-------------|------------|------------|------------|
| 3P | 9A | 4kW | 1NO | 230V AC | MTMA10-3009 | 1 | 60 | 14,86 \$ |
| | 9A | 4kW | 1NC | | MTMA01-3009 | 1 | 60 | 14,86 \$ |
| | 12A | 5,5kW | 1NO | | MTMA10-3012 | 1 | 60 | 15,57 \$ |
| | 12A | 5,5kW | 1NC | | MTMA01-3012 | 1 | 60 | 15,57 \$ |
| | 18A | 7,5kW | 1NO | | MTMA10-3018 | 1 | 60 | 17,96 \$ |
| | 18A | 7,5kW | 1NC | | MTMA01-3018 | 1 | 60 | 17,96 \$ |
| | 25A | 11kW | 1NO | | MTMA10-3025 | 1 | 40 | 24,15 \$ |
| | 25A | 11kW | 1NC | | MTMA01-3025 | 1 | 40 | 24,15 \$ |
| | 32A | 15kW | 1NO | | MTMA10-3032 | 1 | 40 | 37,06 \$ |
| | 32A | 15kW | 1NC | | MTMA01-3032 | 1 | 40 | 37,06 \$ |
| | 40A | 18,5kW | 1NO | | MTMA10-3040 | 1 | 40 | 60,23 \$ |
| | 40A | 18,5kW | 1NC | | MTMA01-3040 | 1 | 40 | 60,23 \$ |
| | 50A | 22kW | 1NO+1NC | | MTMA11-3050 | 1 | 16 | 72,26 \$ |
| | 65A | 30kW | 1NO+1NC | | MTMA11-3065 | 1 | 16 | 89,33 \$ |
| | 80A | 37kW | 1NO+1NC | | MTMA11-3080 | 1 | 12 | 122,94 \$ |
| | 95A | 45kW | 1NO+1NC | | MTMA11-3095 | 1 | 12 | 127,37 \$ |

MTMA SERİSİ



AC KONTAKTÖR YARDIMCI BLOKLARI

| Ürün Kodu | Ürün Adı | Kutu Adedi | Koli Adedi | Fiyat (\$) |
|------------------|---------------------------|------------|------------|------------|
| MTMAUX-UPBLOCKA | AC-3 KONTAKTÖR ÜST BLOK A | | | 4,04 \$ |
| MTMAUX-UPBLOCKB | AC-3 KONTAKTÖR ÜST BLOK B | | | 6,64 \$ |
| MTMAUX-SIDEBLOCK | AC-3 KONTAKTÖR YAN BLOK | | | 8,72 \$ |

MINİ KONTAKTÖRLER

| Kutup Sayısı | In (A) Anma Akımı | kW | Kontakt | Voltaj (V) | Ürün Kodu | Kutu Adedi | Koli Adedi | Fiyat (\$) |
|--------------|----------------------|-------|---------|------------|-----------------|------------|------------|------------|
| 3P | 9A | 4kW | 1NO | 230V AC | MTMK10-3009 | 1 | 100 | 14,46 \$ |
| | 12A | 5,5kW | 1NO | | MTMK10-3012 | 1 | 100 | 15,26 \$ |
| | 16A | 7,5kW | 1NO | | MTMK10-3016 | 1 | 100 | 23,03 \$ |
| | 9A | 4kW | 1NC | 230V AC | MTMK01-3009 | 1 | 100 | 14,46 \$ |
| | 12A | 5,5kW | 1NC | | MTMK01-3012 | 1 | 100 | 15,26 \$ |
| | 16A | 7,5kW | 1NC | | MTMK01-3016 | 1 | 100 | 23,03 \$ |
| | 9A | 4kW | 1NO | 24V DC | MTMK10-3009DC24 | 1 | 100 | 24,19 \$ |
| | 12A | 5,5kW | 1NO | | MTMK10-3012DC24 | 1 | 100 | 26,07 \$ |
| | 16A | 7,5kW | 1NO | | MTMK10-3016DC24 | 1 | 100 | 27,85 \$ |
| | 9A | 4kW | 1NC | 24V DC | MTMK01-3009DC24 | 1 | 100 | 24,19 \$ |
| | 12A | 5,5kW | 1NC | | MTMK01-3012DC24 | 1 | 100 | 26,07 \$ |
| | 16A | 7,5kW | 1NC | | MTMK01-3016DC24 | 1 | 100 | 27,85 \$ |

MTMK SERİSİ



AC KOMPANZASYON BLOKLARI

| Kutup Sayısı | In (A) Anma Akımı | kVAr | Kontakt | Ürün Kodu | Kutu Adedi | Koli Adedi | Fiyat (\$) |
|--------------|----------------------|---------|----------|------------|------------|------------|------------|
| 3P | 18A | 7,5kVAr | 1NO+1NC | MTMAC1-318 | 1 | 32 | 54,17 \$ |
| | 25A | 12kVAr | 1NO+1NC | MTMAC1-325 | 1 | 32 | 70,88 \$ |
| | 32A | 18kVAr | 1NO+1NC | MTMAC1-332 | 1 | 32 | 100,84 \$ |
| | 43A | 20kVAr | 1NO+1NC | MTMAC1-343 | 1 | 16 | 172,41 \$ |
| | 50A | 25kVAr | 2NO +1NC | MTMAC1-350 | 1 | 16 | 178,06 \$ |
| | 65A | 30kVAr | 2NO +1NC | MTMAC1-365 | 1 | 16 | 258,62 \$ |
| | 80A | 40kVAr | 2NO +1NC | MTMAC1-380 | 1 | 16 | 273,13 \$ |
| | 95A | 50kVAr | 2NO +1NC | MTMAC1-395 | 1 | 16 | 281,78 \$ |

MTMAC SERİSİ

MODÜLER KONTAKTÖRLER

MTMCO SERİSİ



| Kutup Sayısı | In (A) Anma Akımı | Kontakt | mm | Ürün Kodu | Kutu Adedi | Koli Adedi | Fiyat (\$) | |
|--------------|----------------------|--------------|---------------|--------------|--------------|------------|------------|-----------|
| 2P | 16A | 1NO+1NC | 18 mm | MTMCO-201611 | 1 | 140 | 17,48 \$ | |
| | 16A | 2NO | | MTMCO-201620 | 1 | 140 | 17,48 \$ | |
| | 16A | 2NC | | MTMCO-201602 | 1 | 140 | 17,48 \$ | |
| | 25A | 1NO+1NC | | MTMCO-202511 | 1 | 140 | 19,21 \$ | |
| | 25A | 2NO | | MTMCO-202520 | 1 | 140 | 19,21 \$ | |
| | 25A | 2NC | | MTMCO-202502 | | 140 | 19,21 \$ | |
| | 32A | 1NO+1NC | 36 mm | MTMCO-203211 | 1 | 70 | 41,86 \$ | |
| | 32A | 2NO | | MTMCO-203220 | 1 | 70 | 41,86 \$ | |
| | 32A | 2NC | | MTMCO-203202 | 1 | 70 | 41,86 \$ | |
| | 40A | 1NO+1NC | | MTMCO-204011 | 1 | 70 | 46,55 \$ | |
| | 40A | 2NO | | MTMCO-204020 | 1 | 70 | 46,55 \$ | |
| | 40A | 2NC | | MTMCO-204002 | 1 | 70 | 46,55 \$ | |
| | 63A | 1NO+1NC | 54 mm | MTMCO-206311 | 1 | 70 | 57,76 \$ | |
| | 63A | 2NO | | MTMCO-206320 | 1 | 70 | 57,76 \$ | |
| | 63A | 2NC | | MTMCO-206302 | 1 | 70 | 57,76 \$ | |
| | 80A | 1NO+1NC | | MTMCO-208011 | 1 | 50 | 110,86 \$ | |
| | 80A | 2NO | | MTMCO-208020 | 1 | 50 | 110,86 \$ | |
| | 80A | 2NC | | MTMCO-208002 | 1 | 50 | 110,86 \$ | |
| 100A | 1NO+1NC | 54 mm | MTMCO-2010011 | 1 | 50 | 110,86 \$ | | |
| 100A | 2NO | | MTMCO-2010020 | 1 | 50 | 110,86 \$ | | |
| 100A | 2NC | | MTMCO-2010002 | 1 | 50 | 110,86 \$ | | |
| 4P | 16A | 2NO+2NC | 36 mm | MTMCO-401622 | 1 | 70 | 24,14 \$ | |
| | 16A | 3NO+1NC | | MTMCO-401631 | 1 | 70 | 24,14 \$ | |
| | 16A | 1NO+3NC | | MTMCO-401613 | 1 | 70 | 24,14 \$ | |
| | 16A | 4NO | | MTMCO-401640 | 1 | 70 | 24,14 \$ | |
| | 16A | 4NC | | MTMCO-401604 | 1 | 70 | 24,14 \$ | |
| | 25A | 2NO+2NC | | MTMCO-402522 | 1 | 70 | 31,03 \$ | |
| | 25A | 3NO+1NC | | MTMCO-402531 | 1 | 70 | 31,03 \$ | |
| | 25A | 1NO+3NC | | MTMCO-402513 | 1 | 70 | 31,03 \$ | |
| | 25A | 4NO | | MTMCO-402540 | 1 | 70 | 31,03 \$ | |
| | 25A | 4NC | MTMCO-402504 | 1 | 70 | 31,03 \$ | | |
| | 32A | 2NO+2NC | 54 mm | MTMCO-403222 | 1 | 50 | 54,48 \$ | |
| | 32A | 3NO+1NC | | MTMCO-403231 | 1 | 50 | 54,48 \$ | |
| | 32A | 1NO+3NC | | MTMCO-403213 | 1 | 50 | 54,48 \$ | |
| | 32A | 4NO | | MTMCO-403240 | 1 | 50 | 54,48 \$ | |
| | 32A | 4NC | | MTMCO-403204 | 1 | 50 | 54,48 \$ | |
| | 40A | 2NO+2NC | | MTMCO-404022 | 1 | 50 | 51,72 \$ | |
| | 40A | 3NO+1NC | | MTMCO-404031 | 1 | 50 | 51,72 \$ | |
| | 40A | 1NO+3NC | | MTMCO-404013 | 1 | 50 | 51,72 \$ | |
| | 40A | 4NO | | MTMCO-404040 | 1 | 50 | 51,72 \$ | |
| | 40A | 4NC | MTMCO-404004 | 1 | 50 | 51,72 \$ | | |
| | 63A | 2NO+2NC | 54 mm | MTMCO-406322 | 1 | 50 | 52,21 \$ | |
| | 63A | 3NO+1NC | | MTMCO-406331 | 1 | 50 | 52,21 \$ | |
| | 63A | 1NO+3NC | | MTMCO-406313 | 1 | 50 | 52,21 \$ | |
| | 63A | 4NO | | MTMCO-406340 | 1 | 50 | 51,72 \$ | |
| | 63A | 4NC | | MTMCO-406304 | 1 | 50 | 52,21 \$ | |
| | 80A | 2NO+2NC | | 108 mm | MTMCO-408022 | 1 | 30 | 179,65 \$ |
| | 80A | 3NO+1NC | | | MTMCO-408031 | 1 | 30 | 179,65 \$ |
| 80A | 1NO+3NC | MTMCO-408013 | | | 1 | 30 | 179,65 \$ | |
| 80A | 4NO | MTMCO-408080 | | | 1 | 30 | 179,65 \$ | |
| 80A | 4NC | MTMCO-408004 | 1 | | 30 | 179,65 \$ | | |
| 100A | 2NO+2NC | MTMCO-410022 | 1 | | 30 | 179,65 \$ | | |
| 100A | 3NO+1NC | MTMCO-410031 | 1 | | 30 | 179,65 \$ | | |
| 100A | 1NO+3NC | MTMCO-410013 | 1 | | 30 | 179,65 \$ | | |
| 100A | 4NO | MTMCO-410040 | 1 | | 30 | 179,65 \$ | | |
| 100A | 4NC | MTMCO-410004 | 1 | 30 | 179,65 \$ | | | |

TERMİK RÖLELER

| Termik Ayar Sahası (A) | Ürün Kodu | Kutu Adedi | Koli Adedi | Fiyat (\$) |
|------------------------|-------------|------------|------------|------------|
| 0,1 ~ 0,16A | MTTR1-M1301 | 1 | 100 | 15,32 \$ |
| 0,16 ~ 0,25A | MTTR1-M1302 | 1 | 100 | 15,32 \$ |
| 0,25 ~ 0,40A | MTTR1-M1303 | 1 | 100 | 15,32 \$ |
| 0,40 ~ 0,63A | MTTR1-M1304 | 1 | 100 | 15,32 \$ |
| 0,63 ~ 1A | MTTR1-M1305 | 1 | 100 | 15,32 \$ |
| 1 ~ 1,6A | MTTR1-M1306 | 1 | 100 | 15,32 \$ |
| 1,6 ~ 2,5A | MTTR1-M1307 | 1 | 100 | 15,32 \$ |
| 2,5 ~ 4A | MTTR1-M1308 | 1 | 100 | 15,32 \$ |
| 4 ~ 6A | MTTR1-M1310 | 1 | 100 | 15,32 \$ |
| 5,5 ~ 8A | MTTR1-M1312 | 1 | 100 | 15,32 \$ |
| 7 ~ 10A | MTTR1-M1314 | 1 | 100 | 15,32 \$ |
| 9 ~ 13A | MTTR1-M1316 | 1 | 100 | 15,32 \$ |
| 12 ~ 18A | MTTR1-M1321 | 1 | 100 | 15,32 \$ |
| 17 ~ 25A | MTTR1-M1322 | 1 | 100 | 15,32 \$ |
| 23 ~ 32A | MTTR2-M2353 | 1 | 75 | 25,23 \$ |
| 30 ~ 40A | MTTR2-M2355 | 1 | 75 | 26,38 \$ |
| 17 ~ 25A BÜYÜK | MTTR3-M3322 | 1 | 50 | 26,90 \$ |
| 23 ~ 32A BÜYÜK | MTTR3-M3353 | 1 | 50 | 26,49 \$ |
| 30 ~ 40A BÜYÜK | MTTR3-M3355 | 1 | 50 | 26,49 \$ |
| 37 ~ 50A | MTTR3-M3357 | 1 | 50 | 26,96 \$ |
| 48 ~ 65A | MTTR3-M3359 | 1 | 50 | 27,28 \$ |
| 55 ~ 70A | MTTR3-M3361 | 1 | 50 | 27,86 \$ |
| 63 ~ 80A | MTTR3-M3363 | 1 | 50 | 30,48 \$ |
| 80 ~ 93A | MTTR3-M3365 | 1 | 50 | 31,63 \$ |

MTTR SERİSİ



MOTOR KORUMA ŞALTERLERİ

| Termik Ayar Sahası (A) | Ürün Kodu | Kutu Adedi | Koli Adedi | Fiyat (\$) |
|------------------------|--------------|------------|------------|------------|
| 0,1 - 0,16A | MTPSO-250016 | 1 | 50 | 30,15 \$ |
| 0,16 - 0,25A | MTPSO-250025 | 1 | 50 | 30,15 \$ |
| 0,25 - 0,40A | MTPSO-250040 | 1 | 50 | 30,15 \$ |
| 0,40 - 0,63A | MTPSO-250063 | 1 | 50 | 31,87 \$ |
| 0,63A | MTPSO-250100 | 1 | 50 | 31,87 \$ |
| 1 - 1,6A | MTPSO-250160 | 1 | 50 | 31,87 \$ |
| 1,6 - 2,5A | MTPSO-250250 | 1 | 50 | 31,87 \$ |
| 2,5 - 4A | MTPSO-250400 | 1 | 50 | 31,87 \$ |
| 4 - 6,3A | MTPSO-250630 | 1 | 50 | 33,18 \$ |
| 6 - 10A | MTPSO-251000 | 1 | 50 | 33,18 \$ |
| 9 - 14A | MTPSO-251400 | 1 | 50 | 33,59 \$ |
| 13 - 18A | MTPSO-251800 | 1 | 50 | 34,41 \$ |
| 17 - 23A | MTPSO-252300 | 1 | 50 | 35,31 \$ |
| 20 - 25A | MTPSO-252500 | 1 | 50 | 35,31 \$ |
| 24 - 32A | MTPSO-253200 | 1 | 50 | 52,27 \$ |
| 25 - 40A | MTPS1-804000 | 1 | 50 | 99,14 \$ |
| 36 - 50A | MTPS1-805000 | 1 | 50 | 105,69 \$ |
| 40 - 63A | MTPS1-806300 | 1 | 50 | 105,69 \$ |
| 56 - 80A | MTPS1-808000 | 1 | 50 | 146,66 \$ |

MTPSO SERİSİ



MOTOR KORUMA ŞALTERİ AKSESUARLARI

| Ürün Kodu | Ürün Adı | Kutu Adedi | Koli Adedi | Fiyat (\$) |
|-------------|--|------------|------------|------------|
| MTPSO-F11 | 1NO+1NC Yardımcı Kontak - Önden Monteli | 10 | 500 | 21,88 \$ |
| MTPSO-F20 | 2NO Yardımcı Kontak - Önden Monteli | 10 | 500 | 21,88 \$ |
| MTPSO-L11 | 1NO+1NC Yardımcı Kontak - Yandan Monteli | 10 | 500 | 15,63 \$ |
| MTPSO-L20 | 2NO Yardımcı Kontak - Yandan Monteli | 10 | 500 | 15,63 \$ |
| MTPS1-L11 | 1NO+1NC Yardımcı Kontak - Yandan Monteli | 10 | 500 | 20,19 \$ |
| MTPS1-L20 | 2NO Yardımcı Kontak - Yandan Monteli | 10 | 500 | 18,79 \$ |
| MTPSO-AB | 230V Şant Açırma Bobini | 1 | 100 | 15,80 \$ |
| MTPSO-DG | 400V Düşük Gerilim Açırma Bobini | 1 | 100 | 66,69 \$ |
| MTPSO-IP55K | IP55 Kutu - Motor Koruma Şalteri | 1 | 50 | 18,05 \$ |

ANAHTAR PRİZ GRUBU



İngiliz Sistem Anahtar Prizler

 **Mutlusan**[®]
electric *41.yıl*

*Ürünlerle İlgili Detaylı Bilgi İçin Yetkili Bölge Temsilcinize Danışabilirsiniz.

MODÜLER SİSTEM anahtar prizler

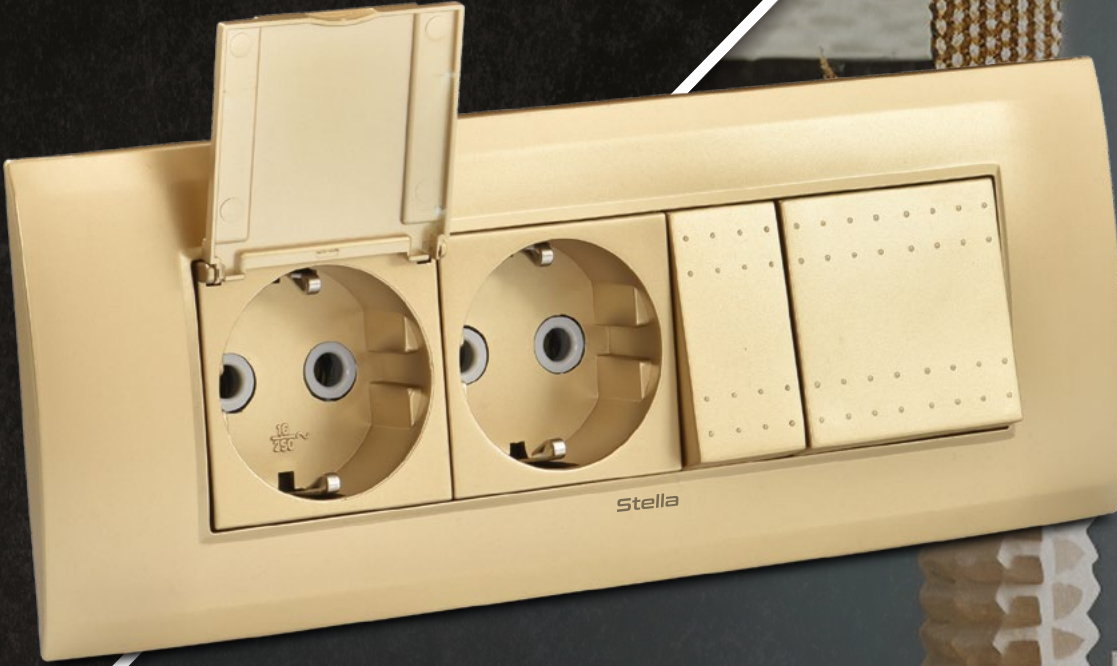

Alışkanlıkları Değiştirin...

DAHA

FAZLA OLASILIK...
FAZLA STİL...
FAZLA...

- Avrupa standartlarına uygun üretim
- Yüksek kaliteli hammadde kullanımı
- Koruma seviyesi: IP 20
- Kolay montaj
- Kişileştirilebilir modül ve çerçeveler
- Geniş dekoratif çerçeve yelpazesi
- Yeni ürünlerle sürekli gelişen ürün yelpazesi

Stella | Alessa

Renkler

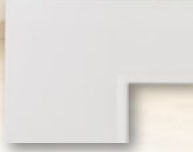

01 - BEYAZ

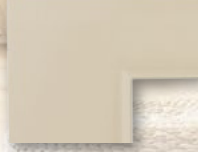

02 - KREM



62 - METALİK SİYAH



80 - ANTİK ALTIN



84 - SİYAH



86 - ANTRASİT



88 - SU YEŞİLİ



92 - ANTİK GÜMÜŞ



95 - FÜME



97 - SATEN BEJ

XX = Renk Kodlarının Karşılığıdır.

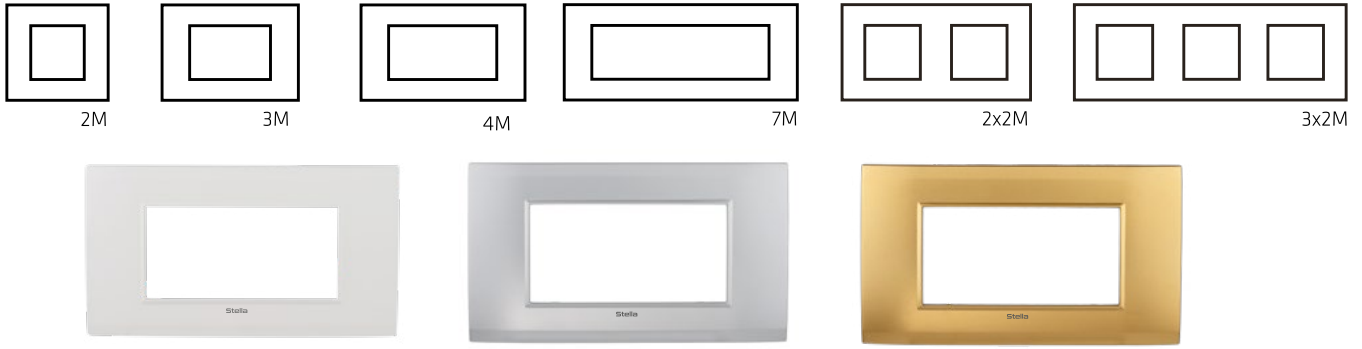

Stella

| Kod | Ürün Tanımı | Kutu Adedi | Koli Adedi | Beyaz/Krem Fiyat (₺) | Renkli Fiyat (₺) |
|---------------|---------------------|------------|------------|----------------------|------------------|
| 2440 800 12XX | Stella 2m Çerçeve | 20 | - | 109,62 | 151,47 |
| 2440 800 13XX | Stella 3m Çerçeve | 20 | - | 126,47 | 168,14 |
| 2440 800 14XX | Stella 4m Çerçeve | 10 | - | 156,92 | 197,82 |
| 2440 800 17XX | Stella 7m Çerçeve | 10 | - | 188,97 | 243,27 |
| 2430 800 12XX | Stella 2x2m Çerçeve | 10 | - | 219,23 | 302,95 |
| 2430 800 13XX | Stella 3x2m Çerçeve | 10 | - | 328,85 | 454,42 |

Alessa

| Kod | Ürün Tanımı | Kutu Adedi | Koli Adedi | Beyaz/Krem Fiyat (₺) | Renkli Fiyat (₺) |
|---------------|-----------------------------------|------------|------------|----------------------|------------------|
| 2420 801 12XX | Alessa 2M Çerçeve - Beyaz Fonlu | 20 | - | 109,62 | 151,47 |
| 2420 801 13XX | Alessa 3M Çerçeve - Beyaz Fonlu | 20 | - | 126,47 | 168,14 |
| 2420 801 14XX | Alessa 4M Çerçeve - Beyaz Fonlu | 10 | - | 156,92 | 197,82 |
| 2420 801 17XX | Alessa 7M Çerçeve - Beyaz Fonlu | 10 | - | 188,97 | 243,27 |
| 2450 801 12XX | Alessa 2x2M Çerçeve - Beyaz Fonlu | 10 | - | 219,23 | 302,95 |
| 2450 801 13XX | Alessa 3x2M Çerçeve - Beyaz Fonlu | 10 | - | 328,85 | 454,42 |

Siyah Fonlu Çerçeveler

| Kod | Ürün Tanımı | Kutu Adedi | Koli Adedi | Beyaz/Krem Fiyat (₺) | Renkli Fiyat (₺) |
|---------------|-----------------------------------|------------|------------|----------------------|------------------|
| 2420 811 12XX | Alessa 2M Çerçeve - Siyah Fonlu | 20 | - | 109,62 | 151,47 |
| 2420 811 13XX | Alessa 3M Çerçeve - Siyah Fonlu | 20 | - | 126,47 | 168,14 |
| 2420 811 14XX | Alessa 4M Çerçeve - Siyah Fonlu | 10 | - | 156,92 | 197,82 |
| 2420 811 17XX | Alessa 7M Çerçeve - Siyah Fonlu | 10 | - | 188,97 | 243,27 |
| 2450 811 12XX | Alessa 2x2M Çerçeve - Siyah Fonlu | 10 | - | 219,23 | 302,95 |
| 2450 811 13XX | Alessa 3x2M Çerçeve - Siyah Fonlu | 10 | - | 328,85 | 454,42 |

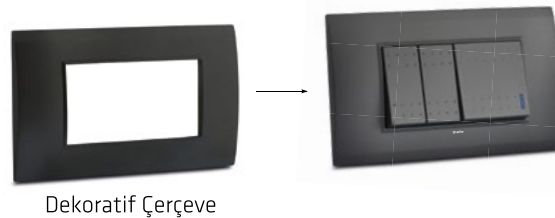
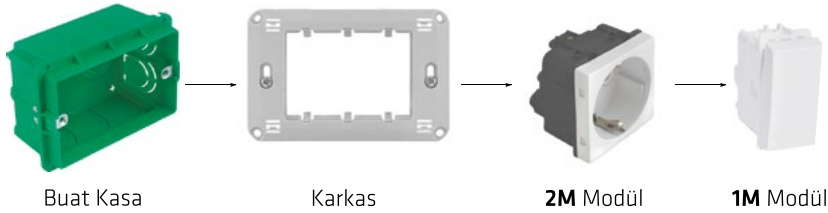

MODÜLLER

| Kod | Ürün Tanımı | Kutu Adedi | Koli Adedi | Fiyat (₺) |
|----------------|--------------------------------------|------------|------------|-----------|
| 2400 701 0200 | Anahtar (1M) | 20 | 120 | 117,69 |
| 2400 703 0200 | Vavien (1M) | 20 | 120 | 117,69 |
| 2400 708 0200 | Ara Vavien(Deviatör)(Permütatör)(1M) | 20 | 120 | 187,05 |
| 2400 705 0200 | Çift Kutuplu Anahtar (1M) | 20 | 120 | 183,31 |
| 2400 707 0200 | Light Butonu (1M) | 20 | 120 | 117,69 |
| 2400 707 0200Z | Zil Butonu (1M) | 20 | 120 | 117,69 |
| 2400 707 0200K | Kapı Otomatığı (1M) | 20 | 120 | 117,69 |
| 2400 706 0200 | Stor/Panjur (Jaluzi) (1M) | 20 | 120 | 253,27 |



| Kod | Ürün Tanımı | Kutu Adedi | Koli Adedi | BeyazKrem Fiyat (₺) | Renkli Fiyat (₺) |
|---------------|-------------------------------------|------------|------------|---------------------|------------------|
| 2400 900 02XX | Topraklı Priz (2M) | 10 | 60 | 129,12 | 181,10 |
| 2400 905 02XX | Topraklı Priz (Çocuk Korumalı) (2M) | 10 | 60 | 143,46 | 201,22 |
| 2400 910 02XX | Kapaklı Top.lı Priz (2M) | 10 | 60 | 135,23 | 190,44 |
| 2400 911 02XX | Kapaklı Top.lı Priz (Çoc.Kor.) (2M) | 10 | 60 | 150,26 | 211,60 |



| Kod | Ürün Tanımı | Kutu Adedi | Koli Adedi | BeyazKrem Fiyat (₺) | Renkli Fiyat (₺) |
|---------------|--------------------------------------|------------|------------|---------------------|------------------|
| 2400 916 02XX | Ups (Fransız) Priz (Çoc. Kor.) (2M) | 10 | 60 | 172,76 | 203,14 |
| 2400 917 02XX | Ups (Fransız) Kapaklı Priz (2M) | 10 | 60 | 172,15 | 241,46 |



| Kod | Ürün Tanımı | Kutu Adedi | Koli Adedi | BeyazKrem Fiyat (₺) | Renkli Fiyat (₺) |
|---------------|---------------------|------------|------------|---------------------|------------------|
| 2400 925 02XX | Universal Priz (1M) | 20 | 120 | 120,90 | 133,40 |
| 2400 560 02XX | Universal Priz (2M) | 10 | 60 | 454,06 | 577,44 |



| Kod | Ürün Tanımı | Kutu Adedi | Koli Adedi | BeyazKrem Fiyat (₺) | Renkli Fiyat (₺) |
|---------------|----------------------|------------|------------|---------------------|------------------|
| 2400 452 02XX | Energy Saver (2M) | 4 | 24 | 648,19 | 712,50 |
| 2400 462 02XX | Energy Saver RF (2M) | 4 | 24 | 1036,72 | 1057,52 |
| 2400 472 02XX | DND/MUR İç Ünite | 10 | 60 | 455,51 | 468,47 |



| Kod | Ürün Tanımı | Kutu Adedi | Koli Adedi | BeyazKrem Fiyat (₺) | Renkli Fiyat (₺) |
|---------------|------------------------|------------|------------|---------------------|------------------|
| 2400 550 02XX | İngiliz Tipi Priz (2M) | 10 | 60 | 373,93 | 450,40 |



| Kod | Ürün Tanımı | Kutu Adedi | Koli Adedi | BeyazKrem Fiyat (₺) | Renkli Fiyat (₺) |
|---------------|-------------------------------------|------------|------------|---------------------|------------------|
| 2400 469 02XX | USB + TYPE-C Şarj Prizi PD 20W (2M) | 10 | 60 | 961,66 | 1.140,52 |



| Kod | Ürün Tanımı | Kutu Adedi | Koli Adedi | BeyazKrem Fiyat (₺) | Renkli Fiyat (₺) |
|---------------|-------------------|------------|------------|---------------------|------------------|
| 2400 920 02XX | İtalyan Priz (1M) | 20 | 120 | 120,90 | 133,40 |



MODÜLLER



| Kod | Ürün Tanımı | Kutu Adedi | Koli Adedi | BeyazKrem Fiyat (₺) | Renkli Fiyat (₺) |
|---------------|---------------------------|------------|------------|---------------------|------------------|
| 2400 441 02XX | Dimmer 100 - 500w (1M) Rc | 20 | 120 | 1.149,86 | 1.197,77 |
| 2400 541 02XX | Dimmer 100 - 500w (1M) CE | 20 | 120 | 773,29 | 805,51 |



| Kod | Ürün Tanımı | Kutu Adedi | Koli Adedi | BeyazKrem Fiyat (₺) | Renkli Fiyat (₺) |
|---------------|---------------------------|------------|------------|---------------------|------------------|
| 2400 442 02XX | Dimmer 100 - 500w (2M) Rc | 10 | 60 | 1.219,38 | 1.270,19 |
| 2400 542 02XX | Dimmer 100 - 500w (2M) CE | 10 | 60 | 987,65 | 1.028,80 |



| Kod | Ürün Tanımı | Kutu Adedi | Koli Adedi | BeyazKrem Fiyat (₺) | Renkli Fiyat (₺) |
|---------------|-------------------------|------------|------------|---------------------|------------------|
| 2400 171 02XX | Tv Prizi (Sonlu) (1M) | 20 | 120 | 543,14 | 556,35 |
| 2400 170 02XX | Tv Prizi (Geçişli) (1M) | 20 | 120 | 543,14 | 556,35 |



| Kod | Ürün Tanımı | Kutu Adedi | Koli Adedi | BeyazKrem Fiyat (₺) | Renkli Fiyat (₺) |
|---------------|----------------------|------------|------------|---------------------|------------------|
| 2400 172 02XX | Tv Prizi F Dişi (1M) | 20 | 120 | 227,88 | 251,15 |



| Kod | Ürün Tanımı | Kutu Adedi | Koli Adedi | BeyazKrem Fiyat (₺) | Renkli Fiyat (₺) |
|---------------|---------------------------|------------|------------|---------------------|------------------|
| 2400 125 02XX | Telefon Prizi (Cat3) (1M) | 20 | 120 | 214,42 | 225,90 |
| 2400 140 02XX | Data Prizi (Cat6) (1M) | 20 | 120 | 255,13 | 276,35 |



| Kod | Ürün Tanımı | Kutu Adedi | Koli Adedi | BeyazKrem Fiyat (₺) | Renkli Fiyat (₺) |
|---------------|----------------------|------------|------------|---------------------|------------------|
| 2400 482 02XX | RCA Çıkışı 2'li (1M) | 20 | 120 | 197,82 | 520,38 |



| Kod | Ürün Tanımı | Kutu Adedi | Koli Adedi | BeyazKrem Fiyat (₺) | Renkli Fiyat (₺) |
|---------------|----------------|------------|------------|---------------------|------------------|
| 2400 121 02XX | Kör Kapak (1M) | 20 | 120 | 19,87 | 42,18 |



| Kod | Ürün Tanımı | Kutu Adedi | Koli Adedi | Fiyat (₺) |
|---------------|-------------|------------|------------|-----------|
| 2400 000 0001 | Mavi Lamba | 50 | - | 66,67 |

TUŞLAR

| Kod | Ürün Tanımı | Kutu Adedi | Koli Adedi | BeyazKrem Fiyat (₺) | Renkli Fiyat (₺) |
|----------------|------------------------------|------------|------------|---------------------|------------------|
| 2410 701 01XX | 1M Anahtar Tuş | 40 | - | 19,87 | 42,18 |
| 2410 701 02XX | 2M Anahtar Tuş | 20 | - | 28,14 | 55,64 |
| Kod | Ürün Tanımı | Kutu Adedi | Koli Adedi | BeyazKrem Fiyat (₺) | Renkli Fiyat (₺) |
| 2410 703 01XX | 1M VavienTuş | 40 | - | 19,87 | 42,18 |
| 2410 703 02XX | 2M Vavien Tuş | 20 | - | 28,14 | 55,64 |
| Kod | Ürün Tanımı | Kutu Adedi | Koli Adedi | BeyazKrem Fiyat (₺) | Renkli Fiyat (₺) |
| 2410 708 01XX | 1M Ara VavienTuş | 40 | - | 19,87 | 42,18 |
| 2410 708 02XX | 2M Ara Vavien Tuş | 20 | - | 28,14 | 55,64 |
| Kod | Ürün Tanımı | Kutu Adedi | Koli Adedi | BeyazKrem Fiyat (₺) | Renkli Fiyat (₺) |
| 2410 707 01XX | 1M Çağırma Light Tuş | 40 | - | 19,87 | 42,18 |
| 2410 707 02XX | 2M Çağırma Light Tuş | 20 | - | 28,14 | 55,64 |
| Kod | Ürün Tanımı | Kutu Adedi | Koli Adedi | BeyazKrem Fiyat (₺) | Renkli Fiyat (₺) |
| 2410 707 01XX | 1M Zil Anahtarı Tuş | 40 | - | 19,87 | 42,18 |
| 2410 707 02XX | 2M Zil Anahtarı Tuş | 20 | - | 28,14 | 55,64 |
| Kod | Ürün Tanımı | Kutu Adedi | Koli Adedi | BeyazKrem Fiyat (₺) | Renkli Fiyat (₺) |
| 2410 707 01XXX | 1M Kapı Otomatığı Tuş | 40 | - | 19,87 | 42,18 |
| 2410 707 02XXX | 2M Kapı Otomatığı Tuş | 20 | - | 28,14 | 55,64 |
| Kod | Ürün Tanımı | Kutu Adedi | Koli Adedi | BeyazKrem Fiyat (₺) | Renkli Fiyat (₺) |
| 2410 706 01XX | 1M Jaluzi Tuş | 40 | - | 19,87 | 42,18 |
| 2410 706 02XX | 2M Jaluzi Tuş | 20 | - | 28,14 | 55,64 |
| Kod | Ürün Tanımı | Kutu Adedi | Koli Adedi | BeyazKrem Fiyat (₺) | Renkli Fiyat (₺) |
| 2410 715 01XX | 1M Işıklı Anahtar Tuş | 40 | - | 19,87 | 42,18 |
| 2410 715 02XX | 2M Işıklı Anahtar Tuş | 20 | - | 28,14 | 55,64 |
| Kod | Ürün Tanımı | Kutu Adedi | Koli Adedi | BeyazKrem Fiyat (₺) | Renkli Fiyat (₺) |
| 2410 716 01XX | 1M Işıklı Vavien Anahtar Tuş | 40 | - | 19,87 | 42,18 |
| 2410 716 02XX | 2M Işıklı Vavien Anahtar Tuş | 20 | - | 28,14 | 55,64 |
| Kod | Ürün Tanımı | Kutu Adedi | Koli Adedi | BeyazKrem Fiyat (₺) | Renkli Fiyat (₺) |
| 2410 717 01XX | 1M Çağırma Light Işıklı Tuş | 40 | - | 19,87 | 42,18 |
| 2410 717 02XX | 2M Çağırma Light Işıklı Tuş | 20 | - | 28,14 | 55,64 |
| Kod | Ürün Tanımı | Kutu Adedi | Koli Adedi | BeyazKrem Fiyat (₺) | Renkli Fiyat (₺) |
| 2410 717 01XXZ | 1M Işıklı Zil Anahtar Tuş | 40 | - | 19,87 | 42,18 |
| 2410 717 02XXZ | 2M Işıklı Zil Anahtar Tuş | 20 | - | 28,14 | 55,64 |
| Kod | Ürün Tanımı | Kutu Adedi | Koli Adedi | BeyazKrem Fiyat (₺) | Renkli Fiyat (₺) |
| 2410 717 01XXX | 1M Işıklı Kapı Anahtar Tuş | 40 | - | 19,87 | 42,18 |
| 2410 717 02XXX | 2M Işıklı Kapı Anahtar Tuş | 20 | - | 28,14 | 55,64 |





TAŞIYICI KAİDELER

| Kod | Ürün Tanımı | Kutu Adedi | Koli Adedi | Fiyat (₺) |
|---------------|---------------------|------------|------------|-----------|
| 2400 500 0217 | Taşıyıcı Kaide (2M) | 10 | - | 44,60 |
| 2400 500 0317 | Taşıyıcı Kaide (3M) | 10 | - | 46,19 |
| 2400 500 0417 | Taşıyıcı Kaide (4M) | 10 | - | 51,79 |
| 2400 500 0717 | Taşıyıcı Kaide (7M) | 10 | - | 79,35 |

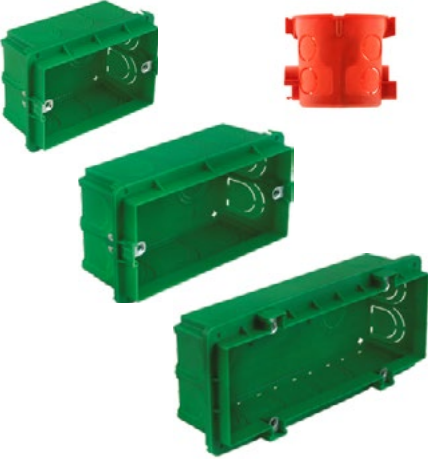

SIVA ALTI BUAT KASALAR

| Kod | Ürün Tanımı | Kutu Adedi | Koli Adedi | Fiyat (₺) |
|----------------------|--|------------|------------|-----------|
| 001 046 180101 00 12 | Çift Kilitlemeli Geçmeli Derin Kasa (2M) | 300 | - | 21,22 |
| 2400 812 1315 | Siva Altı Buat Kasa (3M) | 165 | - | 42,56 |
| 2400 812 1415 | Siva Altı Buat Kasa (4M) | 135 | - | 57,27 |
| 2400 812 1715 | Siva Altı Buat Kasa (7M) | 90 | - | 72,10 |

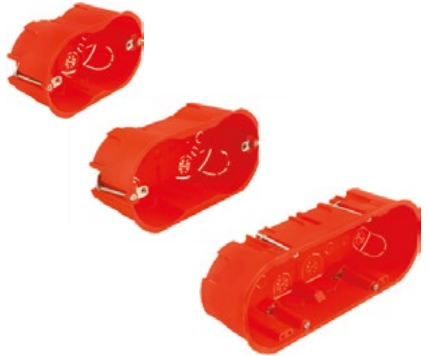

ALÇIPAN KASA

| Kod | Ürün Tanımı | Kutu Adedi | Koli Adedi | Fiyat (₺) |
|---------------|-------------------|------------|------------|-----------|
| 2400 813 1312 | Alçıpan Kasa (3M) | 180 | - | 73,65 |
| 2400 813 1412 | Alçıpan Kasa (4M) | 150 | - | 93,27 |
| 2400 813 1712 | Alçıpan Kasa (7M) | 114 | - | 150,51 |



SIVA ALTI BAĞLANTI APARATI

| Kod | Ürün Tanımı | Kutu Adedi | Koli Adedi | Fiyat (₺) |
|---------------|----------------------------|------------|------------|-----------|
| 2400 818 0011 | Siva Altı Bağlantı Aparatı | 40 | - | 22,93 |

Ritä



Modern tasarımlar,
kusursuz çözümler...



**ANAHA TAR
GRUBU
VİDALI TİP**



2220 401 02XX
Anahtar



2220 402 02XX
Komütatör



2220 403 02XX
Vavien (iki Yollu Anahtar)



2220 404 02XX
Komütatör Vavien



2220 405 02XX
Çift Kutuplu Anahtar



2220 406 02XX
Jalu zi Anahtar



2220 407 02XX
Çağırma



2220 407 02XXX
Kapı Otomatığı Anahtar



2220 407 02XXZ
Zil Anahtar



2220 408 02XX
Deviatör(Ara Vavien)



2220 409 02XX
Uçlu Anahtar



2220 411 02XX
Şofben Anahtar



2220 415 02XX
Işıkli Anahtar (220V)



2220 416 02XX
Işıkli Vavien (220V)



2220 417 02XX
Işıkli Çağırma (220V)



2220 418 02XX
Işıkli Etik. Anahtar (220V)



2220 419 02XX
Işıkli Etik. Çağırma (220V)



2220 422 02XX
Işıkli Zil Etik. Çağırma (12V)



2220 425 02XX
Tek Tuşlu Jalu zi Anahtar (Vidalı)



2220 426 02XX
Işıkli Komütatör



2220 436 02XX
Jalu zi Anahtar (Yaysız - Vidalı)

**ANAHA TAR
GRUBU
KLİPSLİ TİP
(KOLAY BAĞLANTI)**

2220 401 01XX
Anahtar

2220 402 01XX
Komütatör

2220 403 01XX
Vavien (iki Yollu Anahtar)

2220 404 01XX
Komütatör Vavien



2220 405 01XX
Çift Kutuplu Anahtar

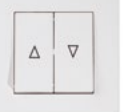

2220 406 01XX
Jalu zi Anahtar



2220 407 01XX
Çağırma



2220 407 01XXX
Kapı Otomatığı Anahtar



2220 407 01XXZ
Zil Anahtar



2220 408 01XX
Deviatör(Ara Vavien)



2220 409 01XX
Uçlu Anahtar



2220 415 01XX
Işıkli Anahtar (220V)



2220 416 01XX
Işıkli Vavien (220V)



2220 417 01XX
Işıkli Çağırma (220V)



2220 418 01XX
Işıkli Etik. Anahtar (220V)



2220 419 01XX
Işıkli Etik. Çağırma (220V)



2220 422 01XX
Işıkli Zil Etik. Çağırma (12V)



2220 426 01XX
Işıkli Komütatör



2220 436 01XX
Jalu zi Anahtar (Yaysız - Klipsli)



**DİMMER
GRUBU**



2220 440 02XX
RL Işıkli Dimmer 600W

2220 444 02XX
RL Işıkli Dimmer 1000W



2220 447 02XX
RC Dimmer 325W



2220 450 01XX
Energy Saver G.sız Işıkli



2220 452 01XX
Energy Saver Gecikmeli Işıkli



2220 470 02XX
Müzik Yayın Anahtar



2220 480 01XX
Hoparlör Prizi

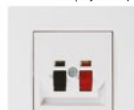

2220 485 02XX
Uyarı Zili



2220 495 02XX
Hareket Sensörü



2220 600 02XX
Tonraklı Priz



2220 601 02XX
Tonraksız Priz



2220 605 02XX
Topraklı Priz (Ç.K.)



2220 606 02XX
Topraksız Priz (Ç.K.)



2220 610 02XX
Kapaklı Topraklı Priz



2220 611 02XX
Kapaklı Topraklı Priz (Ç.K.)



2220 615 02XX
Ups (Fransız) Prizi



2220 616 02XX
Ups (Fransız) Prizi (Ç.K.)



2220 617 02XX
Ups Kapaklı (Fransız) Priz



2220 200 02XX
İkili Topraklı Priz Porselen



2220 201 02XX
İkili Tonraksız Priz Porselen



2220 202 02XX
İkili Tonraklı Priz



2220 203 02XX
İkili Tonraksız Priz



2220 215 01XX



2220 219 02XX
İkili Usb (2.4A) Topraklı Priz



2220 229 02XX
Usb + Type C'li Topraklı Priz

**İLETİŞİM
GRUBU**



2220 125 01XX
Telefon Prizi 1Xrj12 (Cat3)



2220 126 01XX
Telefon Prizi 2Xrj12 (Cat3)



2220 128 01XX
Etiketli Tlf Data Priz (Kon.süz)



2220 135 01XX
Data Prizi 1*Rj45 (Kon.süz)

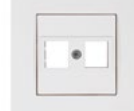

2220 136 01XX
Data Prizi 1*Rj45 (Cat5e)



2220 137 01XX
Data Prizi 2*Rj45 (Kon.süz)



2220 139 01XX
Tlf Data Priz (Rj12 Cat3 + Cat5e)



2220 138 01XX
Data Prizi 2*Rj45 (Cat5e)



2220 140 01XX
Data Prizi 1*Rj45 (Cat6)



2220 141 01XX
Data Prizi 2*Rj45 (Cat6)



2220 455 01XX
Data Prizi 1*Usb



2220 456 01XX
Data Prizi 2*Usb



2220 457 01XX
Data Prizi 1*Hdmi



2220 459 01XX
Data Prizi 1*Usb+1*Hdmi



2220 460 01XX
VGA Priz



2220 461 01XX
İki Çıkışlı Fiber Optik Priz



2220 121 02XX
Kör Kapak

**TV / SAT
GRUBU**



2220 156 02XX
Tv-Sat Prizi (Geçişli) 40B/F Kon.



2220 157 02XX
Tv-Sat Prizi (Sonlu)



2220 166 01XX
Sat Prizi (Geçişli) 40B/F Kon.



2220 167 01XX
Sat Prizi (Sonlu)



2220 170 01XX
Tv Prizi (Geçişli) 110B



2220 171 01XX
Tv Prizi (Sonlu)



2220 172 01XX
Tv Prizi F Dişi



NATURAL



01 - BEYAZ

02 - KREM

AHŞAP

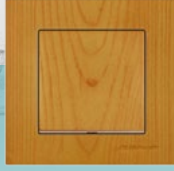
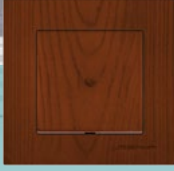

56 - KIRAZ

57 - CEVİZ

58 - MEŞE

METALİK



80 - A.ALTIN

82 - İNOX

83 - TİTANYUM

84 - SİYAH

85 - DORE

86 - ANTRASİT

95 - FÜME

PASTEL



03 - GRİ

04 - KIRMIZI

06 - TURUNCU

08 - SARI

09 - LACİVERT

10 - YEŞİL

11 - PEMBE



12 - MAVİ

25 - MOR

YENİ
RENGİMİZ

| Kod | Ürün Tanımı | Kutu Adedi | Koli Adedi | Beyaz/Krem Fiyat (₺) | Metalik Fiyat (₺) | Ahşap Fiyat (₺) |
|-----|-------------|------------|------------|----------------------|-------------------|-----------------|
|-----|-------------|------------|------------|----------------------|-------------------|-----------------|

Anahtar Grubu Vidalı Tip

* Çoklu çerçeve ile kullanılamaz.

| | | | | | | |
|----------------|--|----|-----|--------|--------|--------|
| 2200 401 02XX | Mek+Tuş Anahtar (Vidalı) | 12 | 120 | 75,81 | 90,14 | 120,17 |
| 2200 402 02XX | Mek+Tuş Komütatör (Vidalı) | 12 | 120 | 101,46 | 123,06 | 138,87 |
| 2200 403 02XX | Mek+Tuş Vavien (İki Yollu Anahtar)(Vidalı) | 12 | 120 | 100,61 | 114,76 | 133,68 |
| 2200 404 02XX | Mek+Tuş Komütatör Vavien (Vidalı) | 12 | 120 | 174,12 | 192,96 | 205,54 |
| 2200 405 02XX | Mek+Tuş Çift Kutuplu Anahtar (Vidalı) | 12 | 120 | 114,41 | 133,20 | 145,89 |
| 2200 406 02XX | Mek+Tuş Jaluzi Anahtarı (Vidalı) | 12 | 120 | 143,74 | 199,78 | 214,45 |
| 2200 407 02XX | Mek+Tuş Çağırma (Vidalı) | 12 | 120 | 85,00 | 126,90 | 131,85 |
| 2200 407 02XXK | Mek+Tuş Kapı Otomatığı Anahtarı (Vidalı) | 12 | 120 | 85,00 | 126,90 | 131,85 |
| 2200 407 02XXZ | Mek+Tuş Zil Anahtarı (Vidalı) | 12 | 120 | 85,00 | 126,90 | 131,85 |
| 2200 408 02XX | Mek+Tuş Deviyatör(Ara Vavien)(Vidalı) | 12 | 120 | 160,81 | 196,41 | 210,62 |
| 2200 409 02XX | Mek+Tuş Üçlü Anahtar (Vidalı) | 12 | 120 | 132,80 | 160,97 | 212,55 |
| 2200 411 02XX | Mek+Tuş Şofben Anahtarı (Vidalı) | 12 | 120 | 155,53 | 194,36 | 211,52 |
| 2200 415 02XX | Mek+Tuş Işıklı Anahtar (220V) (Vidalı) | 12 | 120 | 141,59 | 170,13 | 182,97 |
| 2200 416 02XX | Mek+Tuş Işıklı Vavien (220V) (Vidalı) | 12 | 120 | 180,89 | 207,80 | 268,64 |
| 2200 417 02XX | Mek+Tuş Işıklı Çağırma (220V)(Vidalı) | 12 | 120 | 148,78 | 218,37 | 226,73 |
| 2200 418 02XX | Mek+Tuş Işıklı Etik. Anahtar (220V)(Vidalı) | 12 | 120 | 163,12 | 170,70 | 195,83 |
| 2200 419 02XX | Mek+Tuş Işıklı Etik. Çağırma (220V)(Vidalı) | 12 | 120 | 152,99 | 184,96 | 199,65 |
| 2200 422 02XX | Mek+Tuş Işıklı Zil Etik. Çağırma (12V)(Vidalı) | 12 | 120 | 215,82 | 240,99 | 277,64 |
| 2200 425 02XX | Mek+Tuş Tek Tuşlu Jaluzi Anahtarı (Vidalı) | 12 | 120 | 171,17 | 212,17 | 232,77 |
| 2200 426 02XX | Mek+Tuş Işıklı Komütatör (Vidalı) | 12 | 120 | 192,34 | 236,94 | 251,40 |
| 2200 436 02XX | Mek+Tuş Jaluzi Anahtarı (Yaysız)(Vidalı) | 12 | 120 | 157,89 | 205,33 | 226,70 |

Anahtar Grubu Klipsli Tip (Kolay Bağlantı)

| | | | | | | |
|----------------|---|----|-----|--------|--------|--------|
| 2200 401 01XX | Mek+Tuş Anahtar (Klipsli) | 12 | 120 | 75,81 | 90,14 | 120,17 |
| 2200 402 01XX | Mek+Tuş Komütatör (Klipsli) | 12 | 120 | 101,46 | 123,06 | 138,87 |
| 2200 403 01XX | Mek+Tuş Vavien (İki Yollu Anahtar)(Klipsli) | 12 | 120 | 100,61 | 114,76 | 133,68 |
| 2200 404 01XX | Mek+Tuş Komütatör Vavien (Klipsli) | 12 | 120 | 174,12 | 192,96 | 205,54 |
| 2200 405 01XX | Mek+Tuş Çift Kutuplu Anahtar (Klipsli) | 12 | 120 | 114,41 | 133,20 | 145,89 |
| 2200 406 01XX | Mek+Tuş Jaluzi Anahtarı (Klipsli) | 12 | 120 | 143,74 | 199,78 | 214,45 |
| 2200 407 01XX | Mek+Tuş Çağırma (Klipsli) | 12 | 120 | 85,00 | 126,90 | 131,85 |
| 2200 407 01XXK | Mek+Tuş Kapı Otomatığı Anahtarı (Klipsli) | 12 | 120 | 85,00 | 126,90 | 131,85 |
| 2200 407 01XXZ | Mek+Tuş Zil Anahtarı (Klipsli) | 12 | 120 | 85,00 | 126,90 | 131,85 |
| 2200 408 01XX | Mek+Tuş Deviyatör(Ara Vavien)(Klipsli) | 12 | 120 | 160,81 | 196,41 | 210,62 |
| 2200 409 01XX | Mek+Tuş Üçlü Anahtar (Klipsli) | 12 | 120 | 132,80 | 160,97 | 212,55 |
| 2200 415 01XX | Mek+Tuş Işıklı Anahtar (220V) (Klipsli) | 12 | 120 | 141,59 | 170,13 | 182,97 |
| 2200 416 01XX | Mek+Tuş Işıklı Vavien (220V) (Klipsli) | 12 | 120 | 180,89 | 207,80 | 268,64 |
| 2200 417 01XX | Mek+Tuş Işıklı Çağırma (220V)(Klipsli) | 12 | 120 | 148,78 | 218,37 | 226,73 |
| 2200 418 01XX | Mek+Tuş Işıklı Etik. Anahtar (220V)(Klipsli) | 12 | 120 | 163,12 | 170,70 | 195,83 |
| 2200 419 01XX | Mek+Tuş Işıklı Etik. Çağırma (220V)(Klipsli) | 12 | 120 | 152,99 | 184,96 | 199,65 |
| 2200 422 01XX | Mek+Tuş Işıklı Zil Etik. Çağırma (12V)(Klipsli) | 12 | 120 | 215,82 | 240,99 | 277,64 |
| 2200 426 01XX | Mek+Tuş Işıklı Komütatör (Klipsli) | 12 | 120 | 192,34 | 236,94 | 251,40 |
| 2200 436 01XX | Mek+Tuş Jaluzi Anahtarı (Yaysız)(Klipsli) | 12 | 120 | 157,89 | 205,33 | 226,70 |

Dimmer Grubu

| | | | | | | |
|---------------|--------------------------------|---|----|----------|----------|----------|
| 2200 440 02XX | Mek+Tuş RL Işıklı Dimmer 600W | 8 | 80 | 448,67 | 549,27 | 681,87 |
| 2200 444 02XX | Mek+Tuş RL Işıklı Dimmer 1000W | 8 | 80 | 570,87 | 884,08 | 964,37 |
| 2200 447 02XX | Mek+Tuş RC Dimmer 325W | 8 | 80 | 1.180,73 | 2.134,98 | 2.339,33 |

Elektronik Grubu

| | | | | | | |
|---------------|---------------------------------------|---|----|----------|----------|----------|
| 2200 450 01XX | Mek+Tuş Energy Saver G.siz Işıklı | 8 | 80 | 671,08 | 767,88 | 823,09 |
| 2200 452 01XX | Mek+Tuş Energy Saver Gecikmeli Işıklı | 8 | 80 | 697,69 | 795,06 | 834,18 |
| 2200 470 02XX | Mek+Tuş Müzik Yayın Anahtarı | 8 | 80 | 911,16 | 956,25 | 1.009,68 |
| 2200 480 01XX | Mek+Tuş Hoparlör Prizi | 8 | 80 | 193,34 | 302,97 | 336,29 |
| 2200 485 02XX | Mek+Tuş Uyarı Zili | 8 | 80 | 1.168,06 | 1.249,80 | 1.281,54 |
| 2200 495 02XX | Mek+Tuş Hareket Sensörü | 8 | 80 | 1.466,19 | 1.709,34 | 1.896,46 |

Priz Grubu

| | | | | | | |
|---------------|---|----|-----|--------|----------|----------|
| 2200 600 02XX | Mek+Tuş Topraklı Priz | 12 | 120 | 97,80 | 139,84 | 158,47 |
| 2200 601 02XX | Mek+Tuş Topraksız Priz | 12 | 120 | 84,48 | 117,68 | 147,51 |
| 2200 605 02XX | Mek+Tuş Topraklı Priz (Ç.K.) | 12 | 120 | 119,09 | 142,21 | 230,09 |
| 2200 606 02XX | Mek+Tuş Topraksız Priz (Ç.K.) | 12 | 120 | 95,47 | 122,17 | 171,99 |
| 2200 610 02XX | Mek+Tuş Kapaklı Topraklı Priz | 12 | 120 | 126,78 | 150,81 | 169,86 |
| 2200 611 02XX | Mek+Tuş Kapaklı Topraklı Priz (Ç.K.) | 12 | 120 | 135,28 | 174,34 | 202,25 |
| 2200 615 02XX | Mek+Tuş Ups (Fransız) Prizi | 12 | 120 | 125,45 | 164,25 | 243,43 |
| 2200 616 02XX | Mek+Tuş Ups (Fransız) Prizi (Ç.K.) | 12 | 120 | 179,27 | 216,84 | 242,28 |
| 2200 617 02XX | Mek+Tuş Ups Kapaklı (Fransız) Priz | 12 | 120 | 133,79 | 206,09 | 234,01 |
| 2200 618 02XX | Mek+Tuş Ups Kapaklı (Fr.) Priz (Ç.K.) | 12 | 120 | 190,30 | 211,53 | 239,46 |
| 2200 200 02XX | Mek+Tuş İkili Topraklı Priz Porselen | 5 | 50 | 216,48 | 314,71 | 326,18 |
| 2200 201 02XX | Mek+Tuş İkili Topraksız Priz Porselen | 5 | 50 | 163,79 | 215,06 | 254,91 |
| 2200 202 02XX | Mek+Tuş İkili Topraklı Priz | 5 | 50 | 178,18 | 235,30 | 286,60 |
| 2200 203 02XX | Mek+Tuş İkili Topraksız Priz | 5 | 50 | 142,90 | 188,48 | 232,76 |
| 2200 215 02XX | Mek+Tuş İkili Ups Priz | 5 | 50 | 168,85 | 173,27 | 220,03 |
| 2200 448 01XX | Mek+Tuş Tekli Usb Şarj Prizi | 5 | 50 | 453,74 | 550,14 | 602,20 |
| 2200 449 01XX | Mek+Tuş İkili Usb Şarj Prizi | 5 | 50 | 575,28 | 629,02 | 754,16 |
| 2200 619 02XX | İkili Usb Topraklı Priz (Çerçeve Dahil) | 8 | - | 590,43 | 1.022,28 | 1.078,90 |
| 2200 629 02XX | Rita Usb +Type-C li Topraklı Priz (Çerçeve Dahil) | 8 | - | 696,71 | 1.052,94 | 1.140,18 |



| Kod | Ürün Tanımı | Kutu Adedi | Koli Adedi | Beyaz/Krem Fiyat (₺) | Metalik Fiyat (₺) | Ahşap Fiyat (₺) |
|-----|-------------|------------|------------|----------------------|-------------------|-----------------|
|-----|-------------|------------|------------|----------------------|-------------------|-----------------|

İletişim Grubu

| | | | | | | |
|---------------|---|----|-----|--------|----------|----------|
| 2200 125 01XX | Mek+Tuş Telefon Prizi 1Xrj12 (Cat3) | 12 | 120 | 108,83 | 166,11 | 191,45 |
| 2200 126 01XX | Mek+Tuş Telefon Prizi 2Xrj12 (Cat3) | 12 | 120 | 180,81 | 239,05 | 246,13 |
| 2200 128 01XX | Mek+Tuş Etiketli Tlf Data Priz (Kon.süz) | 12 | 120 | 88,27 | 109,56 | 132,41 |
| 2200 135 01XX | Mek+Tuş Data Prizi 1 *Rj45 (Kon.süz) | 12 | 120 | 67,43 | 92,23 | 135,73 |
| 2200 136 01XX | Mek+Tuş Data Prizi 1 *Rj45 (Cat5e) | 12 | 120 | 254,19 | 371,66 | 386,17 |
| 2200 137 01XX | Mek+Tuş Data Prizi 2 *Rj45 (Kon.süz) | 12 | 120 | 81,90 | 103,86 | 147,24 |
| 2200 138 01XX | Mek+Tuş Data Prizi 2 *Rj45 (Cat5e) | 12 | 120 | 441,53 | 526,88 | 552,01 |
| 2200 139 01XX | Mek+Tuş Tlf Data Priz (Rj12 Cat3 + Cat5e) | 12 | 120 | 301,15 | 487,83 | 508,97 |
| 2200 140 01XX | Mek+Tuş Data Prizi 1 *Rj45 (Cat6) | 12 | 120 | 239,78 | 374,73 | 385,47 |
| 2200 141 01XX | Mek+Tuş Data Prizi 2 *Rj45 (Cat6) | 12 | 120 | 443,00 | 575,74 | 615,83 |
| 2200 455 01XX | Mek+Tuş Data Prizi 1 *Usb | 12 | 120 | 319,59 | 346,86 | 392,34 |
| 2200 456 01XX | Mek+Tuş Data Prizi 2 *Usb | 12 | 120 | 564,41 | 608,01 | 710,56 |
| 2200 457 01XX | Mek+Tuş Data Prizi 1 *Hdmi | 12 | 120 | 439,61 | 452,25 | 497,27 |
| 2200 458 01XX | Mek+Tuş Data Prizi 2 *Hdmi | 12 | 120 | 793,21 | 831,60 | 866,31 |
| 2200 459 01XX | Mek+Tuş Data Prizi 1 *Usb/1 *Hdmi | 12 | 120 | 680,91 | 698,06 | 746,51 |
| 2200 460 01XX | Mek+Tuş VGA Priz | 12 | 120 | 644,63 | 1.039,01 | 1.112,30 |
| 2200 147 01XX | Mek+Tuş Bir Çıkışlı Fiber Optik Priz (RJ45) | 12 | 120 | 220,13 | 291,48 | 320,19 |
| 2200 461 01XX | Mek+Tuş İki Çıkışlı Fiber Optik Priz | 12 | 120 | 256,24 | 317,59 | 348,87 |
| 2200 121 02XX | Mek+Tuş Kör Kapak | 12 | 120 | 59,44 | 125,76 | 135,05 |

TV / SAT Grubu

| | | | | | | |
|---------------|---|----|-----|--------|--------|--------|
| 2200 156 02XX | Mek+Tuş Tv-Sat Prizi (Geçişli) 4DB/F Kon. | 12 | 120 | 506,67 | 596,22 | 763,33 |
| 2200 157 02XX | Mek+Tuş Tv-Sat Prizi (Sonlu) | 12 | 120 | 506,67 | 596,22 | 763,33 |
| 2200 166 01XX | Mek+Tuş Sat Prizi (Geçişli) 4DB/F Kon. | 12 | 120 | 446,61 | 514,94 | 579,17 |
| 2200 167 01XX | Mek+Tuş Sat Prizi (Sonlu) | 12 | 120 | 446,61 | 514,94 | 579,17 |
| 2200 170 01XX | Mek+Tuş Tv Prizi (Geçişli) 11DB | 12 | 120 | 159,50 | 212,44 | 262,72 |
| 2200 171 01XX | Mek+Tuş Tv Prizi (Sonlu) | 12 | 120 | 159,50 | 212,44 | 262,72 |
| 2200 172 01XX | Mek+Tuş Tv Prizi F Dişi | 12 | 120 | 108,12 | 117,56 | 125,07 |

Çerçeveler

| | | | | | | |
|---------------|---|----|-----|--------|--------|--------|
| 2220 800 11XX | Tekli Çerçeve | 20 | 400 | 9,34 | 37,79 | 41,04 |
| 2220 800 12XX | İkili Yatay Çerçeve | 10 | 200 | 48,38 | 74,09 | 84,12 |
| 2220 800 13XX | Üçlü Yatay Çerçeve | 10 | 50 | 75,00 | 108,71 | 137,44 |
| 2220 800 14XX | Dörtlü Yatay Çerçeve | 10 | 50 | 80,29 | 131,13 | 156,71 |
| 2220 800 15XX | Beşli Yatay Çerçeve | 10 | 50 | 93,24 | 213,01 | 248,23 |
| 2220 800 16XX | Altılı Yatay Çerçeve | 10 | 50 | 107,82 | 236,62 | 263,90 |
| 2220 800 22XX | İkili Dikey Çerçeve | 10 | 50 | 48,38 | 74,09 | 84,12 |
| 2220 800 23XX | Üçlü Dikey Çerçeve | 10 | 50 | 75,00 | 108,71 | 137,44 |
| 2220 800 24XX | Dörtlü Dikey Çerçeve | 10 | 50 | 80,29 | 131,13 | 156,71 |
| 2220 800 25XX | Beşli Dikey Çerçeve | 10 | 50 | 93,24 | 213,01 | 248,23 |
| 2220 800 26XX | Altılı Dikey Çerçeve | 10 | 50 | 107,82 | 236,62 | 263,90 |
| 2220 820 12XX | İkili Priz Çerçeve | 12 | 60 | 32,92 | 73,53 | 80,94 |
| 2100 000 11XX | Sıva Üstü Kasa | 12 | 60 | 41,73 | 97,78 | 127,37 |
| 2200 000 11XX | Sıva Üstü Anahtar Kasası (Geçmeli) | - | - | 69,41 | 163,47 | 187,21 |
| 2200 800 00XX | Telefon Tutucu | 24 | 240 | 18,13 | - | - |
| 2200 000 0001 | IP44 Kapaklı Priz Conta (Resmi Sayfa 30'da) | 24 | 120 | 16,87 | - | - |

RİTA PASTEL

Çerçeveler

| | | | | | | |
|---------------|----------------------|----|-----|--|--|--------|
| 2220 800 11XX | Tekli Çerçeve | 20 | 400 | | | 16,48 |
| 2220 800 12XX | İkili Yatay Çerçeve | 10 | 200 | | | 67,37 |
| 2220 800 13XX | Üçlü Yatay Çerçeve | 10 | 50 | | | 110,87 |
| 2220 800 14XX | Dörtlü Yatay Çerçeve | 10 | 50 | | | 138,58 |
| 2220 800 15XX | Beşli Yatay Çerçeve | 10 | 50 | | | 152,68 |
| 2220 800 16XX | Altılı Yatay Çerçeve | 10 | 50 | | | 174,50 |
| 2220 800 22XX | İkili Dikey Çerçeve | 10 | 50 | | | 67,37 |
| 2220 800 23XX | Üçlü Dikey Çerçeve | 10 | 50 | | | 110,87 |
| 2220 800 24XX | Dörtlü Dikey Çerçeve | 10 | 50 | | | 138,58 |
| 2220 800 25XX | Beşli Dikey Çerçeve | 10 | 50 | | | 152,68 |
| 2220 800 26XX | Altılı Dikey Çerçeve | 10 | 50 | | | 174,50 |

Pastel Fiyat (₺)

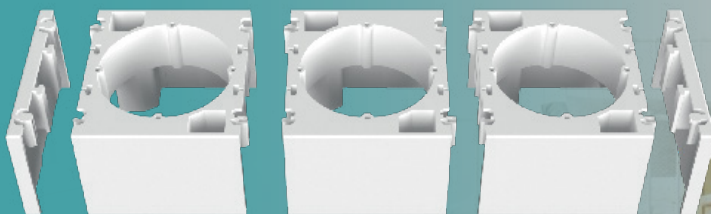

Sıva üstü kasa uygulaması ile istediğiniz kadar "Anahtar Priz Uygulaması" yapabilirsiniz.



Elitra | Plus

Uyum ve zarafet
bir arada...



Elitra | Plus

Elitra Glass



XXX-811



XXX-814



BEYAZ / SİYAH

| Kod | Ürün Tanımı | Kutu Adedi | Fiyat (₺) |
|---------------|----------------------|------------|-----------|
| 2170 XXX 11XX | Tekli Çerçeve | 10 | 510,85 |
| 2170 XXX 12XX | Yatay İkili Çerçeve | 10 | 1.186,59 |
| 2170 XXX 13XX | Yatay Üçlü Çerçeve | 10 | 1.974,53 |
| 2170 XXX 14XX | Yatay Dörtlü Çerçeve | 10 | 2.417,04 |
| 2170 XXX 15XX | Yatay Beşli Çerçeve | 10 | 3.583,70 |
| 2170 XXX 22XX | Dikey İkili Çerçeve | 10 | 1.186,59 |
| 2170 XXX 23XX | Dikey Üçlü Çerçeve | 10 | 1.974,53 |
| 2170 XXX 24XX | Dikey Dörtlü Çerçeve | 10 | 2.417,04 |
| 2170 XXX 25XX | Dikey Beşli Çerçeve | 10 | 3.583,70 |

Elitra Chrome



XXX-821



XXX-822



XXX-824

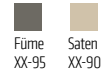

KROM / PASLANMAZ ÇELİK / ALTIN

| Kod | Ürün Tanımı | Kutu Adedi | Fiyat (₺) |
|---------------|----------------------|------------|-----------|
| 2170 XXX 11XX | Tekli Çerçeve | 10 | 1.025,38 |
| 2170 XXX 12XX | Yatay İkili Çerçeve | 10 | 1.580,71 |
| 2170 XXX 13XX | Yatay Üçlü Çerçeve | 10 | 2.130,89 |
| 2170 XXX 14XX | Yatay Dörtlü Çerçeve | 10 | 2.344,70 |
| 2170 XXX 15XX | Yatay Beşli Çerçeve | 10 | 3.034,19 |
| 2170 XXX 16XX | Yatay Altılı Çerçeve | 10 | 4.050,23 |
| 2170 XXX 22XX | Dikey İkili Çerçeve | 10 | 1.580,71 |
| 2170 XXX 23XX | Dikey Üçlü Çerçeve | 10 | 2.130,89 |
| 2170 XXX 24XX | Dikey Dörtlü Çerçeve | 10 | 2.344,70 |
| 2170 XXX 25XX | Dikey Beşli Çerçeve | 10 | 3.034,19 |
| 2170 XXX 26XX | Dikey Altılı Çerçeve | 10 | 4.050,23 |

Elitra | Plus

Elitra Chrome



XXX-825



XXX-825



GÜMÜŞ - PARLAK FÜME

| Kod | Ürün Tanımı | Kutu Adedi | Fiyat (₺) |
|---------------|----------------------|------------|-----------|
| 2170 825 11XX | Tekli Çerçeve | 10 | 685,06 |
| 2170 825 12XX | Yatay İkili Çerçeve | 10 | 1.207,36 |
| 2170 825 13XX | Yatay Üçlü Çerçeve | 10 | 1.753,85 |
| 2170 825 14XX | Yatay Dörtlü Çerçeve | 10 | 2.164,06 |
| 2170 825 15XX | Yatay Beşli Çerçeve | 10 | 2.447,99 |
| 2170 825 16XX | Yatay Altılı Çerçeve | 10 | 2.827,96 |
| 2170 825 22XX | Dikey İkili Çerçeve | 10 | 1.207,36 |
| 2170 825 23XX | Dikey Üçlü Çerçeve | 10 | 1.753,85 |
| 2170 825 24XX | Dikey Dörtlü Çerçeve | 10 | 2.164,06 |
| 2170 825 25XX | Dikey Beşli Çerçeve | 10 | 2.447,99 |
| 2170 825 26XX | Dikey Altılı Çerçeve | 10 | 2.827,96 |

Elitra Chrome



XXX-827



XXX-828



MAT ALÜMİNYUM - MAT SATEN

| Kod | Ürün Tanımı | Kutu Adedi | Fiyat (₺) |
|---------------|----------------------|------------|-----------|
| 2170 XXX 11XX | Tekli Çerçeve | 10 | 636,07 |
| 2170 XXX 12XX | Yatay İkili Çerçeve | 10 | 996,77 |
| 2170 XXX 13XX | Yatay Üçlü Çerçeve | 10 | 1.349,47 |
| 2170 XXX 14XX | Yatay Dörtlü Çerçeve | 10 | 1.639,27 |
| 2170 XXX 15XX | Yatay Beşli Çerçeve | 10 | 2.089,89 |
| 2170 XXX 16XX | Yatay Altılı Çerçeve | 10 | 2.819,48 |
| 2170 XXX 22XX | Dikey İkili Çerçeve | 10 | 996,77 |
| 2170 XXX 23XX | Dikey Üçlü Çerçeve | 10 | 1.349,47 |
| 2170 XXX 24XX | Dikey Dörtlü Çerçeve | 10 | 1.639,27 |
| 2170 XXX 25XX | Dikey Beşli Çerçeve | 10 | 2.089,89 |
| 2170 XXX 26XX | Dikey Altılı Çerçeve | 10 | 2.819,48 |

Elitra | Plus

Elitra Wood



KAYIN / KIRAZ / VENGE

| Kod | Ürün Tanımı | Kutu Adedi | Fiyat (₺) |
|---------------|----------------------|------------|-----------|
| 2170 XXX 11XX | Tekli Çerçeve | 10 | 621,66 |
| 2170 XXX 12XX | Yatay İkili Çerçeve | 10 | 991,42 |
| 2170 XXX 13XX | Yatay Üçlü Çerçeve | 10 | 1.435,52 |
| 2170 XXX 14XX | Yatay Dörtlü Çerçeve | 10 | 1.876,85 |
| 2170 XXX 15XX | Yatay Beşli Çerçeve | 10 | 2.309,18 |
| 2170 XXX 22XX | Dikey İkili Çerçeve | 10 | 991,42 |
| 2170 XXX 23XX | Dikey Üçlü Çerçeve | 10 | 1.435,52 |
| 2170 XXX 24XX | Dikey Dörtlü Çerçeve | 10 | 1.876,85 |
| 2170 XXX 25XX | Dikey Beşli Çerçeve | 10 | 2.309,18 |

Elitra Marble

BLACK QUARTZ / SAND STONE



| Kod | Ürün Tanımı | Kutu Adedi | Fiyat (₺) |
|---------------|----------------------|------------|-----------|
| 2170 XXX 11XX | Tekli Çerçeve | 10 | 773,93 |
| 2170 XXX 12XX | Yatay İkili Çerçeve | 10 | 856,79 |
| 2170 XXX 13XX | Yatay Üçlü Çerçeve | 10 | 1.321,23 |
| 2170 XXX 14XX | Yatay Dörtlü Çerçeve | 10 | 1.725,86 |
| 2170 XXX 15XX | Yatay Beşli Çerçeve | 10 | 2.123,90 |
| 2170 XXX 22XX | Dikey İkili Çerçeve | 10 | 856,79 |
| 2170 XXX 23XX | Dikey Üçlü Çerçeve | 10 | 1.321,23 |
| 2170 XXX 24XX | Dikey Dörtlü Çerçeve | 10 | 1.725,86 |
| 2170 XXX 25XX | Dikey Beşli Çerçeve | 10 | 2.123,90 |

Elitra Ale

NATURAL / SATEN / MAT FÜME



| Kod | Ürün Tanımı | Kutu Adedi | Fiyat (₺) |
|---------------|----------------------|------------|-----------|
| 2170 XXX 11XX | Tekli Çerçeve | 10 | 498,96 |
| 2170 XXX 12XX | Yatay İkili Çerçeve | 10 | 870,56 |
| 2170 XXX 13XX | Yatay Üçlü Çerçeve | 10 | 1.397,92 |
| 2170 XXX 14XX | Yatay Dörtlü Çerçeve | 10 | 1.784,41 |
| 2170 XXX 15XX | Yatay Beşli Çerçeve | 10 | 2.181,59 |
| 2170 XXX 16XX | Yatay Altılı Çerçeve | 10 | 4.078,73 |
| 2170 XXX 22XX | Dikey İkili Çerçeve | 10 | 870,56 |
| 2170 XXX 23XX | Dikey Üçlü Çerçeve | 10 | 1.397,92 |
| 2170 XXX 24XX | Dikey Dörtlü Çerçeve | 10 | 1.784,41 |
| 2170 XXX 25XX | Dikey Beşli Çerçeve | 10 | 2.181,59 |
| 2170 XXX 26XX | Dikey Altılı Çerçeve | 10 | 4.078,73 |

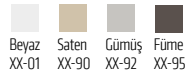

| Kod | Ürün Tanımı | Kutu Adedi | Fiyat (₺) |
|---|---|------------|-----------|
| Anahtar Grubu Vidalı Tip | | | |
| 2270 401 02XX | Mek+Tuş Anahtar | 12 | 90,14 |
| 2270 402 02XX | Mek+Tuş Komütatör | 12 | 123,06 |
| 2270 403 02XX | Mek+Tuş Vavien (İki Yollu Anahtar) | 12 | 114,76 |
| 2270 404 02XX | Mek+Tuş Komütatör Vavien | 12 | 192,96 |
| 2270 405 02XX | Mek+Tuş Çift Kutuplu Anahtar | 12 | 133,20 |
| 2270 406 02XX | Mek+Tuş Jaluzi Anahtarı-Yaylı | 12 | 199,78 |
| 2270 407 02XX | Mek+Tuş Light (Çağırma) | 12 | 126,90 |
| 2270 407 02XXZ | Mek+Tuş Zil Anahtarı | 12 | 126,90 |
| 2270 407 02XXK | Mek+Tuş Kapı Otomatığı Anahtarı | 12 | 126,90 |
| 2270 408 02XX | Mek+Tuş Deviyatör (Ara Vavien) | 12 | 196,41 |
| 2270 409 02XX | Mek+Tuş Üçlü Anahtar | 12 | 160,97 |
| 2270 411 02XX | Mek+Tuş Şöfben Anahtarı | 12 | 194,36 |
| 2270 415 02XX | Mek+Tuş Işıklı Anahtar (220V) | 12 | 170,13 |
| 2270 416 02XX | Mek+Tuş Işıklı Vavien (220V) | 12 | 207,80 |
| 2270 417 02XX | Mek+Tuş Işıklı Çağırma (220V) | 12 | 218,37 |
| 2270 418 02XX | Mek+Tuş Işıklı Etiketli Anahtar (220V) | 12 | 170,70 |
| 2270 419 02XX | Mek+Tuş Işıklı Etiketli Çağırma (220V) | 12 | 184,96 |
| 2270 422 02XX | Mek+Tuş Işıklı Zil Etiketli Çağırma (12V) | 12 | 240,99 |
| 2270 426 02XX | Mek+Tuş Işıklı Komütatör | 12 | 236,94 |
| Anahtar Grubu Klipsli Tip (Kolay Bağlantı) | | | |
| 2270 401 01XX | Mek+Tuş Anahtar | 12 | 90,14 |
| 2270 402 01XX | Mek+Tuş Komütatör | 12 | 123,06 |
| 2270 403 01XX | Mek+Tuş Vavien (İki Yollu Anahtar) | 12 | 114,76 |
| 2270 404 01XX | Mek+Tuş Komütatör Vavien | 12 | 192,96 |
| 2270 405 01XX | Mek+Tuş Çift Kutuplu Anahtar | 12 | 133,20 |
| 2270 406 01XX | Mek+Tuş Jaluzi Anahtarı-Yaylı | 12 | 199,78 |
| 2270 407 01XX | Mek+Tuş Light (Çağırma) | 12 | 126,90 |
| 2270 407 01XXZ | Mek+Tuş Zil Anahtarı | 12 | 126,90 |
| 2270 407 01XXK | Mek+Tuş Kapı Otomatığı Anahtarı | 12 | 126,90 |
| 2270 408 01XX | Mek+Tuş Deviyatör (Ara Vavien) | 12 | 196,41 |
| 2270 409 01XX | Mek+Tuş Üçlü Anahtar | 12 | 160,97 |
| 2270 415 01XX | Mek+Tuş Işıklı Anahtar (220V) | 12 | 170,13 |
| 2270 416 01XX | Mek+Tuş Işıklı Vavien (220V) | 12 | 207,80 |
| 2270 417 01XX | Mek+Tuş Işıklı Çağırma (220V) | 12 | 218,37 |
| 2270 418 01XX | Mek+Tuş Işıklı Etiketli Anahtar (220V) | 12 | 170,70 |
| 2270 419 01XX | Mek+Tuş Işıklı Etiketli Çağırma (220V) | 12 | 184,96 |
| 2270 422 01XX | Mek+Tuş Işıklı Zil Etiketli Çağırma (12V) | 12 | 240,99 |
| 2270 426 01XX | Mek+Tuş Işıklı Komütatör | 12 | 236,94 |
| Dimmer Grubu | | | |
| 2270 440 02XX | Mek+Tuş Işıklı Dimmer 600W | 8 | 549,27 |
| 2270 444 02XX | Mek+Tuş Işıklı Dimmer 1000W | 8 | 884,08 |
| 2270 447 02XX | Mek+Tuş RC Dimmer 325W | 8 | 2.134,98 |
| Elektronik Grubu | | | |
| 2270 450 01XX | Mek+Tuş Energy Saver Gecikmesiz Işıklı | 8 | 767,88 |
| 2270 452 01XX | Mek+Tuş Energy Saver Gecikmeli | 8 | 795,06 |
| 2270 470 02XX | Mek+Tuş Müzik Yayın Anahtarı | 8 | 956,25 |
| 2270 480 01XX | Mek+Tuş Hoparlör Prizi | 8 | 302,97 |
| 2270 485 02XX | Mek+Tuş Uyarı Zili | 8 | 1.249,80 |
| 2270 495 02XX | Mek+Tuş Hareket Sensörü | 8 | 1.709,34 |
| Priz Grubu | | | |
| 2270 600 02XX | Mek+Tuş Topraklı Priz | 12 | 139,84 |
| 2270 601 02XX | Mek+Tuş Topraksız Priz | 12 | 117,68 |
| 2270 605 02XX | Mek+Tuş Topraklı Priz (Ç.K.) | 12 | 142,21 |
| 2270 606 02XX | Mek+Tuş Topraksız Priz (Ç.K.) | 12 | 122,17 |
| 2270 610 02XX | Mek+Tuş Kapaklı Topraklı Priz | 12 | 150,81 |
| 2270 611 02XX | Mek+Tuş Kapaklı Topraklı Priz (Ç.K.) | 12 | 174,34 |
| 2270 615 02XX | Mek+Tuş Ups (Fransız) Prizi | 12 | 164,25 |
| 2270 616 02XX | Mek+Tuş Ups (Fransız) Prizi(Ç.K.) | 12 | 216,84 |
| 2270 617 02XX | Mek+Tuş Ups Kapaklı (Fransız) Priz | 12 | 206,09 |
| 2270 618 02XX | Mek+Tuş Ups Kap. (Fransız) Priz (Ç.K.) | 12 | 211,53 |
| 2270 121 02XX | Mek+Tuş Kör Kapak | 12 | 125,76 |
| 2270 448 01XX | Mek+Tuş Tekli Usb Şarj Prizi | 5 | 550,14 |
| 2270 449 01XX | Mek+Tuş İkili Usb Şarj Prizi | 5 | 629,02 |
| İletişim Grubu | | | |
| 2270 455 01XX | Mek+Tuş Data Prizi 1*Usb | 12 | 346,86 |
| 2270 456 01XX | Mek+Tuş Data Prizi 2*Usb | 12 | 608,01 |
| 2270 457 01XX | Mek+Tuş Data Prizi 1*Hdmi | 12 | 452,25 |
| 2270 458 01XX | Mek+Tuş Data Prizi 2*Hdmi | 12 | 831,60 |
| 2270 459 01XX | Mek+Tuş Data Prizi 1*Usb/1*Hdmi | 12 | 698,06 |
| 2270 125 01XX | Mek+Tuş Telefon Prizi 1*Rj12 Cat3 | 12 | 166,11 |
| 2270 126 01XX | Mek+Tuş Telefon Prizi 2*Rj12 Cat3 | 12 | 239,05 |
| 2270 128 01XX | Mek+Tuş Etiketli Tlf+Data Priz (Kon.süz) | 12 | 109,56 |
| 2270 135 01XX | Mek+Tuş Data Prizi 1*Rj45 (Kon.süz) | 12 | 92,23 |
| 2270 136 01XX | Mek+Tuş Data Prizi 1*Rj45 (Cat5e) | 12 | 371,66 |
| 2270 137 01XX | Mek+Tuş Data Prizi 2*Rj45 (Kon.süz) | 12 | 103,86 |
| 2270 138 01XX | Mek+Tuş Data Prizi 2*Rj45 (Cat5e) | 12 | 526,88 |
| 2270 139 01XX | Mek+Tuş Tlf+Data Priz (Rj12 Cat3+Cat5e) | 12 | 487,83 |
| 2270 140 01XX | Mek+Tuş Data Prizi 1*Rj45 (Cat6) | 12 | 374,73 |
| 2270 141 01XX | Mek+Tuş Data Prizi 2*Rj45 (Cat6) | 12 | 575,74 |
| TV / SAT Grubu | | | |
| 2270 156 02XX | Mek+Tuş Tv-Sat Prizi (Geçişli) 4DB/F Kon. | 12 | 596,22 |
| 2270 157 02XX | Mek+Tuş Tv-Sat Prizi (Sonlu) | 12 | 596,22 |
| 2270 166 01XX | Mek+Tuş Sat Prizi (Geçişli) 4DB/F Konnektör | 12 | 514,94 |
| 2270 167 01XX | Mek+Tuş Sat Prizi (Sonlu) | 12 | 514,94 |
| 2270 170 01XX | Mek+Tuş Tv Prizi (Geçişli) 11DB | 12 | 212,44 |
| 2270 171 01XX | Mek+Tuş Tv Prizi (Sonlu) | 12 | 212,44 |
| 2270 172 01XX | Mek+Tuş Tv Prizi F Dişi | 12 | 117,56 |

Candelä

Şık Çözümler için...



ANAHTAR GRUBU VİDALI TİP



ANAHTAR GRUBU KLİPSLİ TİP (KOLAY BAĞLANTI)

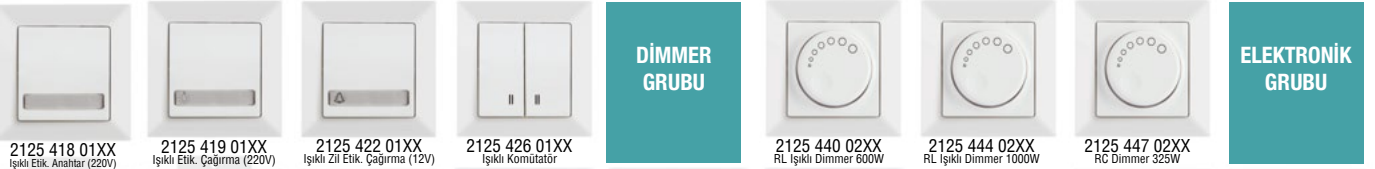

DİMMER GRUBU

ELEKTRONİK GRUBU

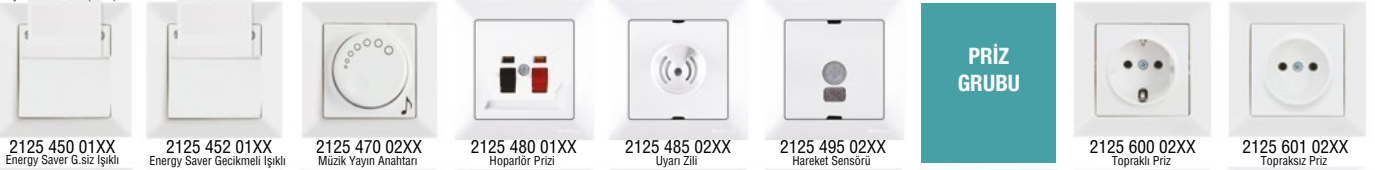

PRİZ GRUBU



İLETİŞİM GRUBU

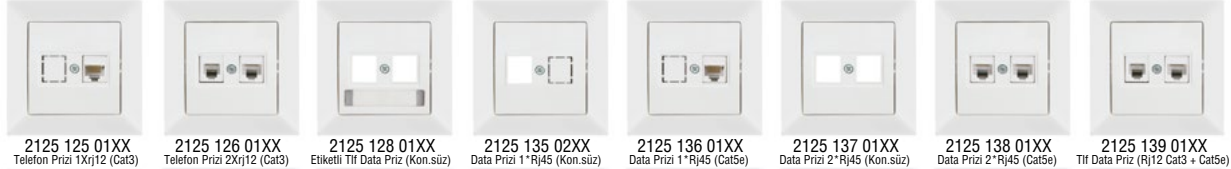

TV / SAT GRUBU



NATURAL



01 -BEYAZ

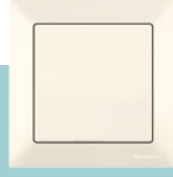

02 -KREM

AHŞAP



56 -KIRAZ



57 -CEVİZ



58 -MEŞE

METALİK



80 -A.ALTIN



82 -İNOX



83 -TİTANYUM



84 -SİYAH



85 -DORE

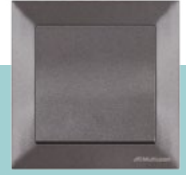

95 -FÜME



| Kod | Ürün Tanımı | Kutu Adedi | Koli Adedi | Beyaz/Krem Fiyat (₺) | Metalik Fiyat (₺) | Ahşap Fiyat (₺) |
|-----|-------------|------------|------------|----------------------|-------------------|-----------------|
|-----|-------------|------------|------------|----------------------|-------------------|-----------------|

Anahtar Grubu Vidalı Tip

| | | | | | | |
|----------------|--|----|-----|--------|--------|--------|
| 2100 401 02XX | Mek+Tuş Anahtar (Vidalı) | 12 | 120 | 75,81 | 90,14 | 120,17 |
| 2100 402 02XX | Mek+Tuş Komütatör (Vidalı) | 12 | 120 | 101,46 | 123,06 | 138,87 |
| 2100 403 02XX | Mek+Tuş Vavien (İki Yollu Anahtar)(Vidalı) | 12 | 120 | 100,61 | 114,76 | 133,68 |
| 2100 404 02XX | Mek+Tuş Komütatör Vavien (Vidalı) | 12 | 120 | 174,12 | 192,96 | 205,54 |
| 2100 405 02XX | Mek+Tuş Çift Kutuplu Anahtar (Vidalı) | 12 | 120 | 114,41 | 133,20 | 145,89 |
| 2100 406 02XX | Mek+Tuş Jalu Anahtarı (Vidalı) | 12 | 120 | 143,74 | 199,78 | 214,45 |
| 2100 407 02XX | Mek+Tuş Çağırma (Vidalı) | 12 | 120 | 85,00 | 126,90 | 131,85 |
| 2100 407 02XXK | Mek+Tuş Kapı Otomatığı Anahtarı (Vidalı) | 12 | 120 | 85,00 | 126,90 | 131,85 |
| 2100 407 02XXZ | Mek+Tuş Zil Anahtarı (Vidalı) | 12 | 120 | 85,00 | 126,90 | 131,85 |
| 2100 408 02XX | Mek+Tuş Deviatör(Ara Vavien)(Vidalı) | 12 | 120 | 160,81 | 196,41 | 210,62 |
| 2100 409 02XX | Mek+Tuş Üçlü Anahtar (Vidalı) | 12 | 120 | 132,80 | 160,97 | 212,55 |
| 2100 411 02XX | Mek+Tuş Şofben Anahtarı (Vidalı) | 12 | 120 | 155,53 | 194,36 | 211,52 |
| 2100 415 02XX | Mek+Tuş Işıklı Anahtar (220V) (Vidalı) | 12 | 120 | 141,59 | 170,13 | 182,97 |
| 2100 416 02XX | Mek+Tuş Işıklı Vavien (220V) (Vidalı) | 12 | 120 | 180,89 | 207,80 | 268,64 |
| 2100 417 02XX | Mek+Tuş Işıklı Çağırma (220V)(Vidalı) | 12 | 120 | 148,78 | 218,37 | 226,73 |
| 2100 418 02XX | Mek+Tuş Işıklı Etik. Anahtar (220V)(Vidalı) | 12 | 120 | 163,12 | 170,70 | 195,83 |
| 2100 419 02XX | Mek+Tuş Işıklı Etik. Çağırma (220V)(Vidalı) | 12 | 120 | 152,99 | 184,96 | 199,65 |
| 2100 422 02XX | Mek+Tuş Işıklı Zil Etik. Çağırma (12V)(Vidalı) | 12 | 120 | 215,82 | 240,99 | 277,64 |
| 2100 426 02XX | Mek+Tuş Işıklı Komütatör (Vidalı) | 12 | 120 | 192,34 | 236,94 | 251,40 |
| 2100 436 02XX | Mek+Tuş Jalu Anahtarı (Yaysız)(Vidalı) | 12 | 120 | 157,89 | 205,33 | 226,70 |

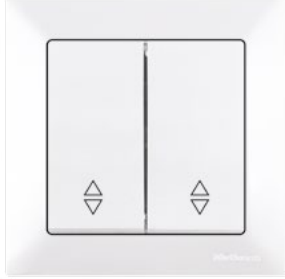

Anahtar Grubu Klipsli Tip (Kolay Bağlantı)

| | | | | | | |
|----------------|---|----|-----|--------|--------|--------|
| 2100 401 01XX | Mek+Tuş Anahtar (Klipsli) | 12 | 120 | 75,81 | 90,14 | 120,17 |
| 2100 402 01XX | Mek+Tuş Komütatör (Klipsli) | 12 | 120 | 101,46 | 123,06 | 138,87 |
| 2100 403 01XX | Mek+Tuş Vavien (İki Yollu Anahtar)(Klipsli) | 12 | 120 | 100,61 | 114,76 | 133,68 |
| 2100 404 01XX | Mek+Tuş Komütatör Vavien (Klipsli) | 12 | 120 | 174,12 | 192,96 | 205,54 |
| 2100 405 01XX | Mek+Tuş Çift Kutuplu Anahtar (Klipsli) | 12 | 120 | 114,41 | 133,20 | 145,89 |
| 2100 406 01XX | Mek+Tuş Jalu Anahtarı (Klipsli) | 12 | 120 | 143,74 | 199,78 | 214,45 |
| 2100 407 01XX | Mek+Tuş Çağırma (Klipsli) | 12 | 120 | 85,00 | 126,90 | 131,85 |
| 2100 407 01XXK | Mek+Tuş Kapı Otomatığı Anahtarı (Klipsli) | 12 | 120 | 85,00 | 126,90 | 131,85 |
| 2100 407 01XXZ | Mek+Tuş Zil Anahtarı (Klipsli) | 12 | 120 | 85,00 | 126,90 | 131,85 |
| 2100 408 01XX | Mek+Tuş Deviatör(Ara Vavien)(Klipsli) | 12 | 120 | 160,81 | 196,41 | 210,62 |
| 2100 409 01XX | Mek+Tuş Üçlü Anahtar (Klipsli) | 12 | 120 | 132,80 | 160,97 | 212,55 |
| 2100 415 01XX | Mek+Tuş Işıklı Anahtar (220V) (Klipsli) | 12 | 120 | 141,59 | 170,13 | 182,97 |
| 2100 416 01XX | Mek+Tuş Işıklı Vavien (220V) (Klipsli) | 12 | 120 | 180,89 | 207,80 | 268,64 |
| 2100 417 01XX | Mek+Tuş Işıklı Çağırma (220V)(Klipsli) | 12 | 120 | 148,78 | 218,37 | 226,73 |
| 2100 418 01XX | Mek+Tuş Işıklı Etik. Anahtar (220V)(Klipsli) | 12 | 120 | 163,12 | 170,70 | 195,83 |
| 2100 419 01XX | Mek+Tuş Işıklı Etik. Çağırma (220V)(Klipsli) | 12 | 120 | 152,99 | 184,96 | 199,65 |
| 2100 422 01XX | Mek+Tuş Işıklı Zil Etik. Çağırma (12V)(Klipsli) | 12 | 120 | 215,82 | 240,99 | 277,64 |
| 2100 426 01XX | Mek+Tuş Işıklı Komütatör (Vidalı) | 12 | 120 | 192,34 | 236,94 | 251,40 |
| 2100 436 01XX | Mek+Tuş Jalu Anahtarı (Yaysız)(Klipsli) | 12 | 120 | 157,89 | 205,33 | 224,94 |



Dimmer Grubu

| | | | | | | |
|---------------|--------------------------------|---|----|----------|----------|----------|
| 2100 440 02XX | Mek+Tuş RL Işıklı Dimmer 600W | 8 | 80 | 448,67 | 549,27 | 681,87 |
| 2100 444 02XX | Mek+Tuş RL Işıklı Dimmer 1000W | 8 | 80 | 570,87 | 884,08 | 964,37 |
| 2100 447 02XX | Mek+Tuş RC Dimmer 325W | 8 | 80 | 1.180,73 | 2.134,98 | 2.339,33 |



Elektronik Grubu

| | | | | | | |
|---------------|---------------------------------------|---|----|----------|----------|----------|
| 2100 450 01XX | Mek+Tuş Energy Saver G.siz Işıklı | 8 | 80 | 671,08 | 767,88 | 823,09 |
| 2100 452 01XX | Mek+Tuş Energy Saver Gecikmeli Işıklı | 8 | 80 | 697,69 | 795,06 | 834,18 |
| 2100 470 02XX | Mek+Tuş Müzik Yayın Anahtarı | 8 | 80 | 911,16 | 956,25 | 1.009,68 |
| 2100 480 01XX | Mek+Tuş Hoparlör Prizi | 8 | 80 | 193,34 | 302,97 | 336,29 |
| 2100 485 02XX | Mek+Tuş Uyarı Zili | 8 | 80 | 1.168,06 | 1.249,80 | 1.281,54 |
| 2100 495 02XX | Mek+Tuş Hareket Sensörü | 8 | 80 | 1.466,19 | 1.709,34 | 1.896,46 |

Priz Grubu

| | | | | | | |
|---------------|---------------------------------------|----|-----|--------|--------|--------|
| 2100 600 02XX | Mek+Tuş Topraklı Priz | 12 | 120 | 97,80 | 139,84 | 158,47 |
| 2100 601 02XX | Mek+Tuş Topraksız Priz | 12 | 120 | 84,48 | 117,68 | 147,51 |
| 2100 605 02XX | Mek+Tuş Topraklı Priz (Ç.K.) | 12 | 120 | 119,09 | 142,21 | 230,09 |
| 2100 606 02XX | Mek+Tuş Topraksız Priz (Ç.K.) | 12 | 120 | 95,47 | 122,17 | 171,99 |
| 2100 610 02XX | Mek+Tuş Kapaklı Topraklı Priz | 12 | 120 | 126,78 | 150,81 | 169,86 |
| 2100 611 02XX | Mek+Tuş Kapaklı Topraklı Priz (Ç.K.) | 12 | 120 | 135,28 | 174,34 | 202,25 |
| 2100 615 02XX | Mek+Tuş Ups (Fransız) Prizi | 12 | 120 | 125,45 | 164,25 | 243,43 |
| 2100 616 02XX | Mek+Tuş Ups (Fransız) Prizi (Ç.K.) | 12 | 120 | 179,27 | 216,84 | 242,28 |
| 2100 617 02XX | Mek+Tuş Ups Kapaklı (Fransız) Priz | 12 | 120 | 133,79 | 206,09 | 234,01 |
| 2100 618 02XX | Mek+Tuş Ups Kapaklı (Fr.) Priz (Ç.K.) | 12 | 120 | 190,30 | 211,53 | 239,46 |
| 2100 200 02XX | Mek+Tuş İkili Topraklı Priz Porselen | 5 | 50 | 216,48 | 314,71 | 326,18 |
| 2100 201 02XX | Mek+Tuş İkili Topraksız Priz Porselen | 5 | 50 | 163,79 | 215,06 | 254,91 |
| 2100 202 02XX | Mek+Tuş İkili Topraklı Priz | 5 | 50 | 178,18 | 235,30 | 286,60 |
| 2100 203 02XX | Mek+Tuş İkili Topraksız Priz | 5 | 50 | 142,90 | 188,48 | 232,76 |
| 2100 215 01XX | Mek+Tuş İkili Ups Priz | 5 | 50 | 168,85 | 173,27 | 220,03 |
| 2100 448 01XX | Mek+Tuş Tekli Usb Şarj Prizi | 5 | 50 | 453,74 | 550,14 | 602,20 |
| 2100 449 01XX | Mek+Tuş İkili Usb Şarj Prizi | 5 | 50 | 575,28 | 629,02 | 754,16 |

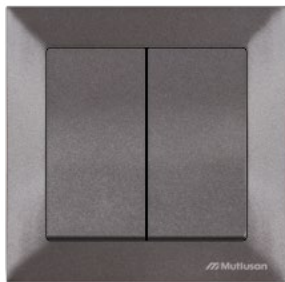

Candelä

Mekanizma + Tuş Ürün Listesi

| Kod | Ürün Tanımı | Kutu Adedi | Koli Adedi | Beyaz/Krem Fiyat (₺) | Metalik Fiyat (₺) | Ahşap Fiyat (₺) |
|-----|-------------|------------|------------|----------------------|-------------------|-----------------|
|-----|-------------|------------|------------|----------------------|-------------------|-----------------|

İletişim Grubu

| | | | | | | |
|---------------|---|----|-----|--------|----------|----------|
| 2100 125 01XX | Mek+Tuş Telefon Prizi 1Xrj12 (Cat3) | 12 | 120 | 108,83 | 166,11 | 191,45 |
| 2100 126 01XX | Mek+Tuş Telefon Prizi 2Xrj12 (Cat3) | 12 | 120 | 180,81 | 239,05 | 246,13 |
| 2100 128 01XX | Mek+Tuş Etiketli Tlf Data Priz (Kon.süz) | 12 | 120 | 88,27 | 109,56 | 132,41 |
| 2100 135 01XX | Mek+Tuş Data Prizi 1*Rj45 (Kon.süz) | 12 | 120 | 67,43 | 92,23 | 135,73 |
| 2100 136 01XX | Mek+Tuş Data Prizi 1*Rj45 (Cat5e) | 12 | 120 | 254,19 | 371,66 | 386,17 |
| 2100 137 01XX | Mek+Tuş Data Prizi 2*Rj45 (Kon.süz) | 12 | 120 | 81,90 | 103,86 | 147,24 |
| 2100 138 01XX | Mek+Tuş Data Prizi 2*Rj45 (Cat5e) | 12 | 120 | 441,53 | 526,88 | 552,01 |
| 2100 139 01XX | Mek+Tuş Tlf Data Priz (Rj12 Cat3 + Cat5e) | 12 | 120 | 301,15 | 487,83 | 508,97 |
| 2100 140 01XX | Mek+Tuş Data Prizi 1*Rj45 (Cat6) | 12 | 120 | 239,78 | 374,73 | 385,47 |
| 2100 141 01XX | Mek+Tuş Data Prizi 2*Rj45 (Cat6) | 12 | 120 | 443,00 | 575,74 | 615,83 |
| 2100 455 01XX | Mek+Tuş Data Prizi 1*Usb | 12 | 120 | 319,59 | 346,86 | 392,34 |
| 2100 456 01XX | Mek+Tuş Data Prizi 2*Usb | 12 | 120 | 564,41 | 608,01 | 710,56 |
| 2100 457 01XX | Mek+Tuş Data Prizi 1*Hdmi | 12 | 120 | 439,61 | 452,25 | 497,27 |
| 2100 458 01XX | Mek+Tuş Data Prizi 2*Hdmi | 12 | 120 | 793,21 | 831,60 | 866,31 |
| 2100 459 01XX | Mek+Tuş Data Prizi 1*Usb/1*Hdmi | 12 | 120 | 680,91 | 698,06 | 746,51 |
| 2100 460 01XX | Mek+Tuş VGA Priz | 12 | 120 | 644,63 | 1.039,01 | 1.112,30 |
| 2100 121 02XX | Mek+Tuş Kör Kapak | 12 | 120 | 59,44 | 125,76 | 135,05 |

TV / SAT Grubu

| | | | | | | |
|---------------|---|----|-----|--------|--------|--------|
| 2100 156 02XX | Mek+Tuş Tv-Sat Prizi (Geçişli) 4DB/F Kon. | 12 | 120 | 506,67 | 596,22 | 763,33 |
| 2100 157 02XX | Mek+Tuş Tv-Sat Prizi (Sonlu) | 12 | 120 | 506,67 | 596,22 | 763,33 |
| 2100 166 01XX | Mek+Tuş Sat Prizi (Geçişli) 4DB/F Kon. | 12 | 120 | 446,61 | 514,94 | 579,17 |
| 2100 167 01XX | Mek+Tuş Sat Prizi (Sonlu) | 12 | 120 | 446,61 | 514,94 | 579,17 |
| 2100 170 01XX | Mek+Tuş Tv Prizi (Geçişli) 11DB | 12 | 120 | 159,50 | 212,44 | 262,72 |
| 2100 171 01XX | Mek+Tuş Tv Prizi (Sonlu) | 12 | 120 | 159,50 | 212,44 | 262,72 |
| 2100 172 01XX | Mek+Tuş Tv Prizi F Dişi | 12 | 120 | 108,12 | 117,56 | 125,07 |

Çerçeveseler

| | | | | | | |
|---------------|---|----|-----|--------|--------|--------|
| 2125 800 11XX | Tekli Çerçeve | 20 | 400 | 9,34 | 37,79 | 41,04 |
| 2125 800 12XX | İkili Yatay Çerçeve | 10 | 200 | 48,38 | 74,09 | 84,12 |
| 2125 800 13XX | Üçlü Yatay Çerçeve | 10 | 50 | 75,00 | 108,71 | 137,44 |
| 2125 800 14XX | Dörtlü Yatay Çerçeve | 10 | 50 | 80,29 | 131,13 | 156,71 |
| 2125 800 15XX | Beşli Yatay Çerçeve | 10 | 50 | 93,24 | 213,01 | 248,23 |
| 2125 800 16XX | Altılı Yatay Çerçeve | 10 | 50 | 107,82 | 236,62 | 263,90 |
| 2125 800 22XX | İkili Dikey Çerçeve | 10 | 50 | 48,38 | 74,09 | 84,12 |
| 2125 800 23XX | Üçlü Dikey Çerçeve | 10 | 50 | 75,00 | 108,71 | 137,44 |
| 2125 800 24XX | Dörtlü Dikey Çerçeve | 10 | 50 | 80,29 | 131,13 | 156,71 |
| 2125 800 25XX | Beşli Dikey Çerçeve | 10 | 50 | 93,24 | 213,01 | 248,23 |
| 2125 800 26XX | Altılı Dikey Çerçeve | 10 | 50 | 107,82 | 236,62 | 263,90 |
| 2125 820 12XX | İkili Priz Çerçeve | 12 | 60 | 32,92 | 73,53 | 80,94 |
| 2100 000 11XX | Sıva Üstü Kasa | 12 | 60 | 41,73 | 97,78 | 127,37 |
| 2200 000 0001 | IP44 Kapaklı Priz Conta (Resmi Sayfa 30'da) | 24 | 120 | 16,87 | | |

İngiliz Tip

| | | | | | | |
|---------------|-----------------------------------|----|-----|--------|---|---|
| 2190 500 0201 | İngiliz Tipi Anahtarlı Priz Beyaz | 12 | 120 | 205,33 | - | - |
|---------------|-----------------------------------|----|-----|--------|---|---|

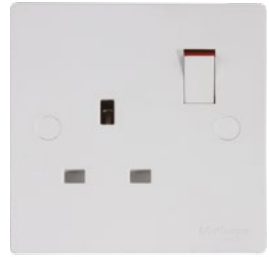

Candelä





SPEAKHONE

RCA

3,5 SES JAKI

XLR ERKEK

XLR DIŐI

USB PRINTER

RİTA MODÜLER SİSTEM

| Kod | Ürün Tanımı | Kutu Adedi | Fiyat |
|---------------|---------------------------|------------|---|
| 2200 250 01XX | Mek+Tuş Speakhone Prizi | 1 | MÜŐTERİ TEMSİLCİSİNE FİYAT SORUNUZ |
| 2200 251 01XX | Mek+Tuş RCA Prizi | 1 | |
| 2200 252 01XX | Mek+Tuş 3,5 Ses Jaki | 1 | |
| 2200 253 01XX | Mek+Tuş XLR Erkek Prizi | 1 | |
| 2200 254 01XX | Mek+Tuş XLR Diőı Prizi | 1 | |
| 2200 255 01XX | Mek+Tuş Usb Printer Prizi | 1 | |

ENERGY SAVER ÜRÜN LİSTESİ

| Kod | Ürün Tanımı | Kutu Adedi | Fiyat |
|---------------|---|------------|---|
| 2110 052 0001 | Energy Saver Kapak | 1 | MÜŐTERİ TEMSİLCİSİNE FİYAT SORUNUZ |
| 2100 012 01XX | Mek+Tuş Impuls Anahtar | 12 | |
| 2100 023 01XX | Mek+Tuş Impuls Komütatör | 12 | |
| 2100 024 01XX | Mek+Tuş Impuls Işıklı Anahtar (220V) | 12 | |
| 2100 027 01XX | Mek+Tuş Impuls Işıklı Komütatör | 12 | |
| 2125 010 0101 | Otel Uyarı İç Ünitesi Komütatörü (Mekanik) Işıklı | 12 | |
| 2220 010 0101 | Rita Otel Uyarı İç Ünitesi Komütatörü (Mekanik) Işıklı | 12 | |
| 2220 010 0201 | Rita Otel Uyarı İç Ünitesi Komütatörü (Mekanik) Işıklı Vidalı | 12 | |
| 2200 412 01XX | Rita Mek Tuş Impuls Anahtar (Klipsli) | 12 | |
| 2200 412 02XX | Rita Mek Tuş Impuls Anahtar (Vidalı) | 12 | |
| 2200 423 01XX | Rita Mek Tuş Impuls Komütatör (Klipsli) | 12 | |
| 2200 423 02XX | Rita Mek Tuş Impuls Komütatör (Vidalı) | 12 | |
| 2200 424 01XX | Rita Mek Tuş Impuls Işıklı Anahtar(Klipsli) | 12 | |
| 2200 424 02XX | Rita Mek Tuş Impuls Işıklı Anahtar (Vidalı) | 12 | |
| 2200 427 01XX | Rita Mek Tuş Impuls Işıklı Komütatör (Klipsli) | 12 | |
| 2200 427 02XX | Rita Mek Tuş Impuls Işıklı Komütatör (Vidalı) | 12 | |

BELLA

YENİ



Uzun ömürlü, nemli mekanlarda güvenli kullanım...





BELLA Serisi

Beyaz / Gri Ürün Listesi

| Kod | Ürün Tanımı | Kutu Adedi | Koli Adedi | Fiyat (₺) |
|----------------------|-----------------------------------|------------|------------|-----------|
| Anahtar Grubu | | | | |
| 2151 001 02XX | Anahtar | 8 | 80 | 111,85 |
| 2151 002 02XX | Komütatör | 8 | 80 | 143,96 |
| 2151 003 02XX | Vavien (İki Yollu Anahtar) | 8 | 80 | 128,80 |
| 2151 005 02XX | Çift Kutuplu Anahtar | 8 | 80 | 144,85 |
| 2151 006 02XX | Jaluzi Anahtarı | 8 | 80 | 173,04 |
| 2151 007 02XXK | Kapı Otomatığı Anahtarı | 8 | 80 | 128,08 |
| 2151 007 02XXZ | Zil Anahtarı | 8 | 80 | 128,08 |
| 2151 007 02XX | Çağırma Anahtarı | 8 | 80 | 128,08 |
| 2151 008 02XX | Deviatör (Ara Vavien) | 8 | 80 | 183,02 |
| Priz Grubu | | | | |
| 2151 180 02XX | Kapaklı Topraklı Priz | 8 | 80 | 122,00 |
| 2151 210 02XX | Kapaklı Topraklı İkili Priz | 8 | 80 | 230,65 |
| 2151 220 02XX | Kapaklı Topraklı İkili Dikey Priz | 8 | 80 | 266,63 |
| 2151 511 02XX | İkili Anahtar + Topraklı Priz | 4 | 40 | 241,54 |
| 2151 521 02XX | İkili Komitatör + Topraklı Priz | 4 | 40 | 263,81 |
| Buat Grubu | | | | |
| 2151 000 01XX | 6 Çıkış Buat | 8 | 80 | 79,99 |

Beyaz 01

Gri 03



BELLA Serisi

Ahşap Ürün Listesi

| Kod | Ürün Tanımı | Kutu Adedi | Koli Adedi | Fiyat (₺) |
|----------------------|-----------------------------------|------------|------------|-----------|
| Anahtar Grubu | | | | |
| 2151 001 02XX | Anahtar Ahşap | 8 | 80 | 145,41 |
| 2151 002 02XX | Komütatör Ahşap | 8 | 80 | 187,15 |
| 2151 003 02XX | Vavien (İki Yollu Anahtar) Ahşap | 8 | 80 | 167,44 |
| 2151 005 02XX | Çift Kutuplu Anahtar Ahşap | 8 | 80 | 188,31 |
| 2151 006 02XX | Jaluzi Anahtarı Ahşap | 8 | 80 | 224,95 |
| 2151 007 02XX | Çağırma Anahtarı Ahşap | 8 | 80 | 166,50 |
| 2151 007 02XXK | Kapı Otomatığı Anahtarı Ahşap | 8 | 80 | 166,50 |
| 2151 007 02XXZ | Zil Anahtarı Ahşap | 8 | 80 | 166,50 |
| Priz Grubu | | | | |
| 2151 180 02XX | Kapaklı Topraklı Priz | 8 | 80 | 158,60 |
| 2151 210 02XX | Kapaklı Topraklı İkili Priz | 8 | 80 | 299,85 |
| 2151 220 02XX | Kapaklı Topraklı İkili Dikey Priz | 8 | 80 | 346,62 |
| 2151 511 02XX | İkili Anahtar + Topraklı Priz | 4 | 40 | 314,00 |
| 2151 521 02XX | İkili Komitatör + Topraklı Priz | 4 | 40 | 342,95 |
| Buat Grubu | | | | |
| 2151 000 01XX | 6 Çıkış Buat | 8 | 80 | 103,99 |

A. Kayın 40

K. Ceviz 41

Maun 44

Armut 49

NORA

YENİ



Riskleri minimize eden, şık ve kullanışlı tasarım.

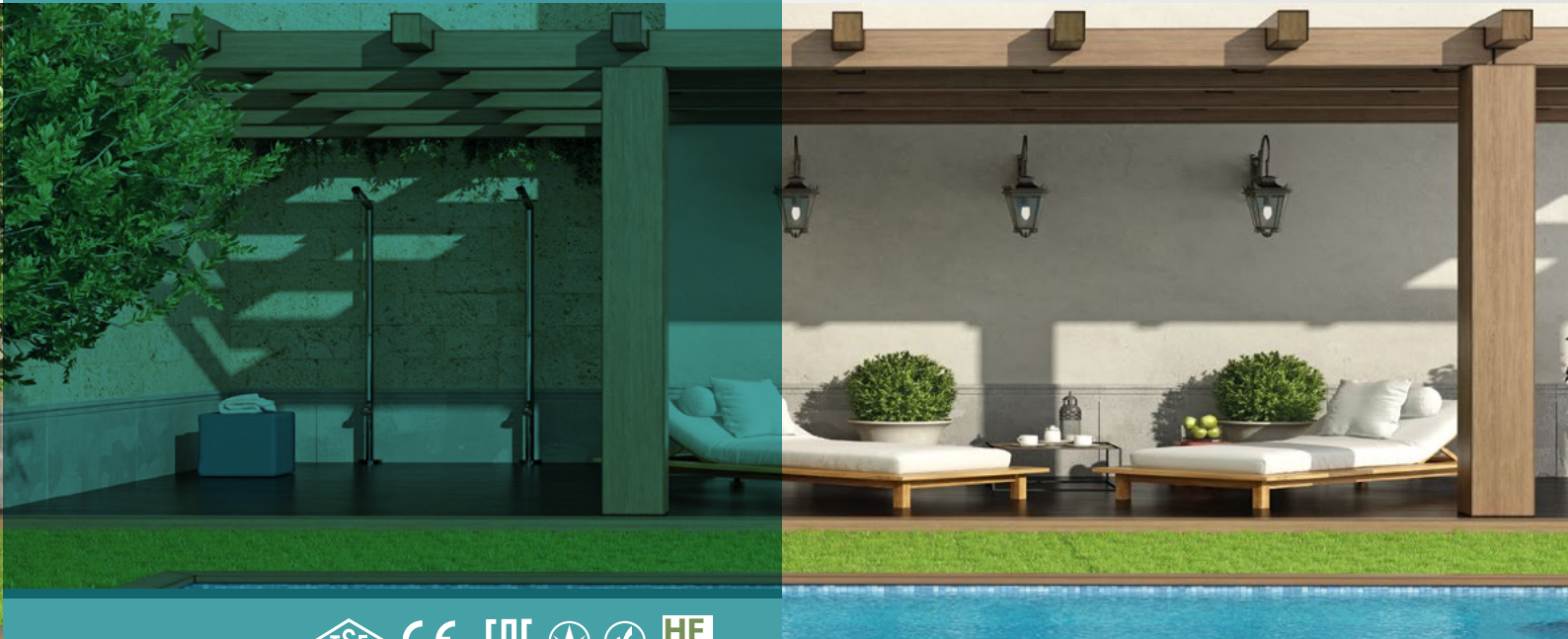



NORA Serisi

Beyaz / Gri Ürün Listesi

| Kod | Ürün Tanımı | Kutu Adedi | Koli Adedi | Fiyat (₺) |
|----------------------|----------------------------|------------|------------|-----------|
| Anahtar Grubu | | | | |
| 2155 001 02XX | Anahtar | 8 | 80 | 117,73 |
| 2155 002 02XX | Komütatör | 8 | 80 | 151,63 |
| 2155 003 02XX | Vavien (iki Yollu Anahtar) | 8 | 80 | 135,58 |
| 2155 004 02XX | Komütatör Vavien | 8 | 80 | 181,71 |
| 2155 005 02XX | Çift Kutuplu Anahtar | 8 | 80 | 156,11 |
| 2155 007 02XX | Çağırma Anahtarı | 8 | 80 | 134,89 |
| 2155 007 02XXZ | Zil Anahtarı | 8 | 80 | 134,89 |
| 2155 008 02XX | Deviatör (Ara Vavien) | 8 | 80 | 192,64 |
| 2155 025 02XX | Jaluzi Anahtarı | 8 | 80 | 176,62 |
| 2155 037 02XX | Acil Çağırma (İpli) | 8 | 80 | 217,93 |

Priz Grubu

| | | | | |
|---------------|--|---|----|--------|
| 2155 180 02XX | Kapaklı Topraklı Priz | 8 | 80 | 129,03 |
| 2155 187 02XX | Kapaklı Topraklı UPS Priz | 8 | 80 | 130,40 |
| 2155 188 02XX | Kapaklı Topraklı UPS Priz (Çocuk Korumalı) | 8 | 80 | 141,56 |
| 2155 210 02XX | Kapaklı Topraklı İkili Priz | 4 | 40 | 242,86 |
| 2155 217 02XX | Kapaklı Topraklı İkili UPS Priz | 4 | 40 | 213,21 |
| 2155 220 02XX | Kapaklı Topraklı İkili Dikey Priz | 4 | 40 | 234,12 |
| 2155 227 02XX | Kapaklı Topraklı İkili Dikey UPS Priz | 4 | 40 | 241,58 |
| 2155 511 02XX | İkili Anahtar + Topraklı Priz | 4 | 40 | 254,25 |
| 2155 521 02XX | İkili Komitatör + Topraklı Priz | 4 | 40 | 277,69 |

Buat Grubu

| | | | | |
|---------------|--------------|---|----|-------|
| 2155 000 01XX | 4 Çıkış Buat | 8 | 80 | 66,66 |
|---------------|--------------|---|----|-------|



BRON

Sıva üstü uygulamalarda
sorunsuz işlevsel çözümler...



BRON Natural

Sıva Üstü Anahtar Priz Serisi

Beyaz / Krem Ürün Listesi



Beyaz 01
Krem 02

| Kod | Ürün Tanımı | Kutu Adedi | Koli Adedi | Fiyat (₺) |
|---------------|--|------------|------------|-----------|
| 2160 301 02XX | Bron S/Ü Anahtar | 12 | 120 | 98,04 |
| 2160 302 02XX | Bron S/Ü Komütatör | 12 | 120 | 117,62 |
| 2160 303 02XX | Bron S/Ü Vavien | 12 | 120 | 119,02 |
| 2160 307 02XX | Bron S/Ü Light (Çağırma) | 12 | 120 | 99,14 |
| 2160 315 02XX | Bron S/Ü Işıklı Anahtar (220V) | 12 | 120 | 154,33 |
| 2160 316 02XX | Bron S/Ü Işıklı Vavien (220V) | 12 | 120 | 169,11 |
| 2160 317 02XX | Bron S/Ü Işıklı Light (Çağırma) (220V) | 12 | 120 | 157,80 |
| 2160 326 02XX | Bron S/Ü Işıklı Komütatör | 12 | 120 | 154,86 |
| 2160 100 02XX | Bron S/Ü Topraklı Priz | 12 | 120 | 122,32 |
| 2160 101 02XX | Bron S/Ü Topraksız Priz | 12 | 120 | 115,44 |
| 2160 103 02XX | Bron S/Ü Topraklı Priz Porselen | 12 | 120 | 153,58 |
| 2160 104 02XX | Bron S/Ü Topraksız Priz Porselen | 12 | 120 | 113,72 |
| 2160 110 02XX | Bron S/Ü Kapaklı Topraklı Priz | 10 | 100 | 135,94 |
| 2160 113 02XX | Bron S/Ü Kapaklı Topraklı Priz Porselen | 10 | 100 | 157,65 |
| 2160 115 02XX | Bron S/Ü Ups (Fransız) Priz | 12 | 120 | 120,17 |
| 2160 125 02XX | Bron S/Ü Telefon Prizi 1*Rj12 Cat3 | 12 | 120 | 117,34 |
| 2160 136 02XX | Bron S/Ü Data Prizi 1*Rj45 (Cat5) | 12 | 120 | 129,48 |
| 2160 140 02XX | Bron S/Ü Data Prizi 1*Rj45 (Cat6) | 12 | 120 | 163,29 |
| 2160 166 02XX | Bron S/Ü Sat Prizi (Geçişli) 4Db/F Konnektör | 12 | 120 | 292,11 |
| 2160 167 02XX | Bron S/Ü Sat Prizi (Sonlu) | 12 | 120 | 292,11 |
| 2160 170 02XX | Bron S/Ü Tv Prizi (Geçişli) | 12 | 120 | 246,89 |
| 2160 171 02XX | Bron S/Ü Tv Prizi (Sonlu) | 12 | 120 | 246,89 |
| 2160 200 02XX | Bron S/Ü İkili Topraklı Priz Porselen | 6 | 60 | 202,14 |
| 2160 201 02XX | Bron İkili Topraksız Priz Porselen | 6 | 60 | 161,28 |
| 2160 202 02XX | Bron S/Ü İkili Topraklı Priz | 6 | 60 | 185,21 |
| 2160 203 02XX | Bron S/Ü İkili Topraksız Priz | 6 | 60 | 148,36 |
| 2160 215 02XX | Bron S/Ü İkili Ups (Fransız) Priz | 6 | 60 | 153,38 |

BRON Ahşap

Sıva Üstü Anahtar Priz Serisi

Meşe / Ceviz Ürün Listesi



Meşe 58
Ceviz 57

| Kod | Ürün Tanımı | Kutu Adedi | Koli Adedi | Fiyat (₺) |
|---------------|--|------------|------------|-----------|
| 2160 301 02XX | Bron S/Ü Anahtar | 12 | 120 | 129,38 |
| 2160 302 02XX | Bron S/Ü Komütatör | 12 | 120 | 150,19 |
| 2160 303 02XX | Bron S/Ü Vavien | 12 | 120 | 153,87 |
| 2160 307 02XX | Bron S/Ü Light (Çağırma) | 12 | 120 | 133,47 |
| 2160 315 02XX | Bron S/Ü Işıklı Anahtar (220V) | 12 | 120 | 174,23 |
| 2160 316 02XX | Bron S/Ü Işıklı Vavien (220V) | 12 | 120 | 189,11 |
| 2160 317 02XX | Bron S/Ü Işıklı Light (Çağırma) (220V) | 12 | 120 | 177,56 |
| 2160 326 02XX | Bron S/Ü Işıklı Komütatör | 12 | 120 | 192,51 |
| 2160 100 02XX | Bron S/Ü Topraklı Priz | 12 | 120 | 183,75 |
| 2160 101 02XX | Bron S/Ü Topraksız Priz | 12 | 120 | 140,32 |
| 2160 103 02XX | Bron S/Ü Topraklı Priz Porselen | 12 | 120 | 173,50 |
| 2160 104 02XX | Bron S/Ü Topraksız Priz Porselen | 12 | 120 | 144,33 |
| 2160 110 02XX | Bron S/Ü Kapaklı Topraklı Priz | 10 | 100 | 178,25 |
| 2160 113 02XX | Bron S/Ü Kapaklı Topraklı Priz Porselen | 10 | 100 | 199,96 |
| 2160 115 02XX | Bron S/Ü Ups (Fransız) Priz | 12 | 120 | 150,82 |
| 2160 125 02XX | Bron S/Ü Telefon Prizi 1*Rj12 Cat3 | 12 | 120 | 161,51 |
| 2160 136 02XX | Bron S/Ü Data Prizi 1*Rj45 (Cat5) | 12 | 120 | 228,66 |
| 2160 140 02XX | Bron S/Ü Data Prizi 1*Rj45 (Cat6) | 12 | 120 | 245,91 |
| 2160 166 02XX | Bron S/Ü Sat Prizi (Geçişli) 4Db/F Konnektör | 12 | 120 | 327,39 |
| 2160 167 02XX | Bron S/Ü Sat Prizi (Sonlu) | 12 | 120 | 327,39 |
| 2160 170 02XX | Bron S/Ü Tv Prizi (Geçişli) | 12 | 120 | 275,06 |
| 2160 171 02XX | Bron S/Ü Tv Prizi (Sonlu) | 12 | 120 | 275,06 |
| 2160 200 02XX | Bron S/Ü İkili Topraklı Priz Porselen | 6 | 60 | 312,13 |
| 2160 201 02XX | Bron İkili Topraksız Priz Porselen | 6 | 60 | 232,19 |
| 2160 202 02XX | Bron S/Ü İkili Topraklı Priz | 6 | 60 | 308,95 |
| 2160 203 02XX | Bron S/Ü İkili Topraksız Priz | 6 | 60 | 229,18 |
| 2160 215 02XX | Bron S/Ü İkili Ups (Fransız) Priz | 6 | 60 | 353,77 |

Fiş Prizler Grup Prizler



Taşınabilir enerji ihtiyacınız için en kullanışlı seçenekler...



Ri-tech Grup Prizler

| Kod | Ürün Tanımı | Kutu Adedi | Fiyat (₺) |
|----------------------|---|------------|-----------|
| 001 175 210001 00 00 | İKİLİ TOP.LI GRUP PRİZ(Ç.K.)(KLEMENSLİ) | 25 | 128,63 |
| 001 175 210002 01 00 | İKİLİ TOP.LI GRUP PRİZ(Ç.K.)(1 MT) | 12 | 249,68 |
| 001 175 210002 02 00 | İKİLİ TOP.LI GRUP PRİZ(Ç.K.)(2 MT) | 12 | 314,25 |
| 001 175 210002 03 00 | İKİLİ TOP.LI GRUP PRİZ(Ç.K.)(3 MT) | 12 | 378,80 |
| 001 175 210002 05 00 | İKİLİ TOP.LI GRUP PRİZ(Ç.K.)(5 MT) | 12 | 532,56 |
| 001 175 220001 00 00 | İKİLİ ANAHT. TOP.LI GRUP PRİZ(Ç.K.)(KLEMENSLİ) | 25 | 274,53 |
| 001 175 220002 01 00 | İKİLİ ANAHT. TOP.LI GRUP PRİZ(Ç.K.)(1 MT) | 12 | 397,89 |
| 001 175 220002 02 00 | İKİLİ ANAHT. TOP.LI GRUP PRİZ(Ç.K.)(2 MT) | 12 | 462,46 |
| 001 175 220002 03 00 | İKİLİ ANAHT. TOP.LI GRUP PRİZ(Ç.K.)(3 MT) | 12 | 527,02 |
| 001 175 220002 05 00 | İKİLİ ANAHT. TOP.LI GRUP PRİZ(Ç.K.)(5 MT) | 12 | 657,25 |
| 001 175 310001 00 00 | ÜÇLÜ TOP.LI GRUP PRİZ(Ç.K.)(KLEMENSLİ) | 25 | 166,41 |
| 001 175 310002 01 00 | ÜÇLÜ TOP.LI GRUP PRİZ(Ç.K.)(1 MT) | 12 | 276,53 |
| 001 175 310002 02 00 | ÜÇLÜ TOP.LI GRUP PRİZ(Ç.K.)(2 MT) | 12 | 341,10 |
| 001 175 310002 03 00 | ÜÇLÜ TOP.LI GRUP PRİZ(Ç.K.)(3 MT) | 12 | 405,72 |
| 001 175 310002 05 00 | ÜÇLÜ TOP.LI GRUP PRİZ(Ç.K.)(5 MT) | 12 | 535,48 |
| 001 175 320001 00 00 | ÜÇLÜ ANAHT. TOP.LI GRUP PRİZ(Ç.K.)(KLEMENSLİ) | 25 | 324,37 |
| 001 175 320002 01 00 | ÜÇLÜ ANAHT. TOP.LI GRUP PRİZ(Ç.K.)(1 MT) | 12 | 439,21 |
| 001 175 320002 02 00 | ÜÇLÜ ANAHT. TOP.LI GRUP PRİZ(Ç.K.)(2 MT) | 12 | 501,16 |
| 001 175 320002 03 00 | ÜÇLÜ ANAHT. TOP.LI GRUP PRİZ(Ç.K.)(3 MT) | 12 | 566,09 |
| 001 175 320002 05 00 | ÜÇLÜ ANAHT. TOP.LI GRUP PRİZ(Ç.K.)(5 MT) | 12 | 695,29 |
| 001 175 350001 00 00 | ÜÇLÜ USB ANAHT. TOP.LI GRUP PRİZ(Ç.K.)(KLEMENSLİ) | 25 | 701,42 |
| 001 175 350002 02 00 | ÜÇLÜ USB ANAHT. TOP.LI GRUP PRİZ(Ç.K.)(2 MT) | 12 | 949,70 |
| 001 175 350002 03 00 | ÜÇLÜ USB ANAHT. TOP.LI GRUP PRİZ(Ç.K.)(3 MT) | 12 | 1.032,70 |
| 001 175 350002 05 00 | ÜÇLÜ USB ANAHT. TOP.LI GRUP PRİZ(Ç.K.)(5 MT) | 12 | 1.218,36 |
| 001 175 410001 00 00 | DÖRTLÜ TOP.LI GRUP PRİZ(Ç.K.)(KLEMENSLİ) | 25 | 207,27 |
| 001 175 410002 01 00 | DÖRTLÜ TOP.LI GRUP PRİZ(Ç.K.)(1 MT) | 12 | 317,51 |
| 001 175 410002 02 00 | DÖRTLÜ TOP.LI GRUP PRİZ(Ç.K.)(2 MT) | 12 | 378,38 |
| 001 175 410002 03 00 | DÖRTLÜ TOP.LI GRUP PRİZ(Ç.K.)(3 MT) | 12 | 452,30 |
| 001 175 410002 05 00 | DÖRTLÜ TOP.LI GRUP PRİZ(Ç.K.)(5 MT) | 12 | 578,02 |
| 001 175 420001 00 00 | DÖRTLÜ ANAHT. TOP.LI GRUP PRİZ(Ç.K.)(KLEMENSLİ) | 25 | 395,03 |
| 001 175 420002 01 00 | DÖRTLÜ ANAHT. TOP.LI GRUP PRİZ(Ç.K.)(1 MT) | 12 | 488,58 |
| 001 175 420002 02 00 | DÖRTLÜ ANAHT. TOP.LI GRUP PRİZ(Ç.K.)(2 MT) | 12 | 546,20 |
| 001 175 420002 03 00 | DÖRTLÜ ANAHT. TOP.LI GRUP PRİZ(Ç.K.)(3 MT) | 12 | 626,33 |
| 001 175 420002 05 00 | DÖRTLÜ ANAHT. TOP.LI GRUP PRİZ(Ç.K.)(5 MT) | 12 | 740,91 |
| 001 175 610001 00 00 | ALTILI TOP.LI GRUP PRİZ(Ç.K.)(KLEMENSLİ) | 25 | 282,40 |
| 001 175 610002 01 00 | ALTILI TOP.LI GRUP PRİZ(Ç.K.)(1 MT) | 12 | 404,40 |
| 001 175 610002 02 00 | ALTILI TOP.LI GRUP PRİZ(Ç.K.)(2 MT) | 12 | 527,59 |
| 001 175 610002 03 00 | ALTILI TOP.LI GRUP PRİZ(Ç.K.)(3 MT) | 12 | 627,91 |
| 001 175 610002 05 00 | ALTILI TOP.LI GRUP PRİZ(Ç.K.)(5 MT) | 12 | 815,96 |
| 001 175 620001 00 00 | ALTILI ANAHT. TOP.LI GRUP PRİZ(Ç.K.)(KLEMENSLİ) | 25 | 493,30 |
| 001 175 620002 01 00 | ALTILI ANAHT. TOP.LI GRUP PRİZ(Ç.K.)(1 MT) | 12 | 593,21 |
| 001 175 620002 02 00 | ALTILI ANAHT. TOP.LI GRUP PRİZ(Ç.K.)(2 MT) | 12 | 680,27 |
| 001 175 620002 03 00 | ALTILI ANAHT. TOP.LI GRUP PRİZ(Ç.K.)(3 MT) | 12 | 772,66 |
| 001 175 620002 05 00 | ALTILI ANAHT. TOP.LI GRUP PRİZ(Ç.K.)(5 MT) | 12 | 981,10 |
| 001 175 650001 00 00 | ALTILI USB ANAHT. TOP.LI GRUP PRİZ(Ç.K.)(KLEMENSLİ) | 25 | 771,18 |
| 001 175 650002 02 00 | ALTILI USB ANAHT. TOP.LI GRUP PRİZ(Ç.K.)(2 MT) | 12 | 1.121,98 |
| 001 175 650002 03 00 | ALTILI USB ANAHT. TOP.LI GRUP PRİZ(Ç.K.)(3 MT) | 12 | 1.235,10 |
| 001 175 650002 05 00 | ALTILI USB ANAHT. TOP.LI GRUP PRİZ(Ç.K.)(5 MT) | 12 | 1.423,38 |



Ri-tech Grup Prizler

| Kod | Ürün Tanımı | Kutu Adedi | Fiyat (₺) |
|----------------------|---|------------|-----------|
| 001 175 330001 00 00 | ÜÇLÜ UPS GRUP PRİZ(Ç.K.)(KLEMENSLİ) | 25 | 198,10 |
| 001 175 330002 02 00 | ÜÇLÜ UPS GRUP PRİZ(Ç.K.)(2 MT) | 12 | 435,61 |
| 001 175 330002 03 00 | ÜÇLÜ UPS GRUP PRİZ(Ç.K.)(3 MT) | 12 | 517,95 |
| 001 175 330002 05 00 | ÜÇLÜ UPS GRUP PRİZ(Ç.K.)(5 MT) | 12 | 674,22 |
| 001 175 340001 00 00 | ÜÇLÜ ANAHT. UPS GRUP PRİZ(Ç.K.)(KLEMENSLİ) | 25 | 348,29 |
| 001 175 340002 02 00 | ÜÇLÜ ANAHT. UPS GRUP PRİZ(Ç.K.)(2 MT) | 12 | 509,19 |
| 001 175 340002 03 00 | ÜÇLÜ ANAHT. UPS GRUP PRİZ(Ç.K.)(3 MT) | 12 | 616,44 |
| 001 175 340002 05 00 | ÜÇLÜ ANAHT. UPS GRUP PRİZ(Ç.K.)(5 MT) | 12 | 763,95 |
| 001 175 430001 00 00 | DÖRTLÜ UPS GRUP PRİZ(Ç.K.)(KLEMENSLİ) | 25 | 291,91 |
| 001 175 430002 02 00 | DÖRTLÜ UPS GRUP PRİZ(Ç.K.)(2 MT) | 12 | 544,01 |
| 001 175 430002 03 00 | DÖRTLÜ UPS GRUP PRİZ(Ç.K.)(3 MT) | 12 | 619,56 |
| 001 175 430002 05 00 | DÖRTLÜ UPS GRUP PRİZ(Ç.K.)(5 MT) | 12 | 854,74 |
| 001 175 440001 00 00 | DÖRTLÜ ANAHT. UPS GRUP PRİZ(Ç.K.)(KLEMENSLİ) | 25 | 461,96 |
| 001 175 440002 02 00 | DÖRTLÜ ANAHT. UPS GRUP PRİZ(Ç.K.)(2 MT) | 12 | 761,59 |
| 001 175 440002 03 00 | DÖRTLÜ ANAHT. UPS GRUP PRİZ(Ç.K.)(3 MT) | 12 | 825,22 |
| 001 175 440002 05 00 | DÖRTLÜ ANAHT. UPS GRUP PRİZ(Ç.K.)(5 MT) | 12 | 1.074,64 |
| 001 175 630001 00 00 | ALTI Lİ UPS GRUP PRİZ(Ç.K.)(KLEMENSLİ) | 25 | 402,12 |
| 001 175 630002 02 00 | ALTI Lİ UPS GRUP PRİZ(Ç.K.)(2 MT) | 12 | 711,49 |
| 001 175 630002 03 00 | ALTI Lİ UPS GRUP PRİZ(Ç.K.)(3 MT) | 12 | 923,01 |
| 001 175 630002 05 00 | ALTI Lİ UPS GRUP PRİZ(Ç.K.)(5 MT) | 12 | 1.183,52 |
| 001 175 640001 00 00 | ALTI Lİ ANAHT. UPS GRUP PRİZ(Ç.K.)(KLEMENSLİ) | 25 | 588,65 |
| 001 175 640002 02 00 | ALTI Lİ ANAHT. UPS GRUP PRİZ(Ç.K.)(2 MT) | 12 | 895,22 |
| 001 175 640002 03 00 | ALTI Lİ ANAHT. UPS GRUP PRİZ(Ç.K.)(3 MT) | 12 | 1.014,55 |
| 001 175 640002 05 00 | ALTI Lİ ANAHT. UPS GRUP PRİZ(Ç.K.)(5 MT) | 12 | 1.344,07 |



ALTI Lİ ŞOK KORUMALI
USB ANAHTAR TOPRAKLI
GRUP PRİZ



ÜÇLÜ ŞOK KORUMALI
ANAHTAR TOPRAKLI
GRUP PRİZ

Ri-tech Akım (Şok) Korumalı Grup Priz

| Kod | Ürün Tanımı | Kutu Adedi | Fiyat (₺) |
|----------------------|---|------------|-----------|
| 001 175 660002 15 00 | ALTI Lİ ŞOK.KORUMA USB ANAHT. TOPLI GRUP PRİZ(Ç.K.) (3X1.5 1.5 MT) | 12 | 1.660,59 |
| 001 175 670002 15 00 | ALTI Lİ ŞOK.KORUMA ANAHT. TOPLI GRUP PRİZ(Ç.K.) (3X1.5 1.5 MT) | 12 | 1.298,12 |
| 001 175 370002 15 00 | ÜÇLÜ ŞOK.KORUMA ANAHT. TOPLI GRUP PRİZ(Ç.K.) (3X1.5 1.5 MT) | 12 | 1.085,20 |
| 001 888 100004 00 00 | TEKLİ ŞOK KORUMALI PRİZ | 12 | 537,78 |



USB + TYPE-C
ŞARJ ADAPTÖR



TEKLİ ŞOK KORUMALI PRİZ

Ri-tech USB Şarj

| Kod | Ürün Tanımı | Kutu Adedi | Fiyat (₺) |
|----------------------|--------------------------------|------------|-----------|
| 001 888 100002 00 00 | 2'Lİ USB ŞARJ ADAPTÖR 2,4A | 20 | 296,49 |
| 001 888 100003 00 00 | USB + TYPE-C ŞARJ ADAPTÖR 2,4A | 20 | 320,51 |

| Kod | Ürün Tanımı | Kutu Adedi | Koli Adedi | Beyaz/Krem Fiyat (₺) | Metalik Fiyat (₺) | Ahşap Fiyat (₺) |
|---------------|---|------------|------------|----------------------|-------------------|-----------------|
| 2220 629 02XX | RİTA USB +TYPE-C'Lİ TOPRAKLI PRİZ (ÇERÇEVE DAHİL) | 8 | - | 696,71 | 1.052,94 | 1.140,18 |



* Çoklu çerçeve ile kullanılamaz.



Yeniliklerin müjdecisi...

Artık daha teknolojik bir hayat var...
Ri-tech serisi yenilikçi ürünleri ile
hayatınızı kolaylaştırmak için
yanıbaşınızda...

Olimpia Grup Prizler

Ürün Listesi

| Kod | Ürün Tanımı | Kutu Adedi | Fiyat (₺) |
|----------------------|---|------------|-----------|
| 001 171 290001 00 00 | İkili Topraksız Grup Priz (Klemensli) Olimpia | 25 | 88,90 |
| 001 171 290002 02 00 | İkili Topraksız Grup Priz (2Mt) Olimpia | 12 | 229,47 |
| 001 171 290002 03 00 | İkili Topraksız Grup Priz (3Mt) Olimpia | 12 | 270,53 |
| 001 171 290002 05 00 | İkili Topraksız Grup Priz (5Mt) Olimpia | 12 | 351,08 |
| 001 171 210001 00 00 | İkili Topraklı Grup Priz (Klemensli) Olimpia | 25 | 122,20 |
| 001 171 210002 02 00 | İkili Topraklı Grup Priz (2Mt) Olimpia | 12 | 298,54 |
| 001 171 210002 03 00 | İkili Topraklı Grup Priz (3M) Olimpia | 12 | 359,86 |
| 001 171 210002 05 00 | İkili Topraklı Grup Priz (5M) Olimpia | 12 | 505,93 |
| 001 171 390001 00 00 | Üçlü Topraksız Grup Priz (Klemensli) Olimpia | 25 | 133,12 |
| 001 171 390002 02 00 | Üçlü Topraksız Grup Priz (2Mt) Olimpia | 12 | 270,18 |
| 001 171 390002 03 00 | Üçlü Topraksız Grup Priz(3Mt) Olimpia | 12 | 311,30 |
| 001 171 390002 05 00 | Üçlü Topraksız Grup Priz (5Mt) Olimpia | 12 | 396,71 |
| 001 171 310001 00 00 | Üçlü Grup Priz Topraklı (Klemensli) Olimpia | 25 | 158,09 |
| 001 171 310002 02 00 | Üçlü Topraklı Grup Priz (2Mt) Olimpia | 12 | 324,05 |
| 001 171 310002 03 00 | Üçlü Topraklı Grup Priz (3Mt) Olimpia | 12 | 385,43 |
| 001 171 310002 05 00 | Üçlü Topraklı Grup Priz (5Mt) Olimpia | 12 | 508,70 |
| 001 171 320001 00 00 | Üçlü Topraklı Grup Priz (Klemensli Anahtarlı) Olimpia | 25 | 308,16 |
| 001 171 320002 02 00 | Üçlü Topraklı Grup Priz (Anahtarlı 2 Mt) Olimpia | 12 | 476,11 |
| 001 171 320002 03 00 | Üçlü Topraklı Grup Priz (Anahtarlı 3 Mt) Olimpia | 12 | 537,79 |
| 001 171 320002 05 00 | Üçlü Topraklı Grup Priz (Anahtarlı 5 Mt) Olimpia | 12 | 660,53 |
| 001 171 340001 00 00 | Üçlü Ups Grup Priz (Klemensli) Olimpia | 25 | 188,19 |
| 001 171 330001 02 00 | Üçlü Ups Grup Priz (2Mt) Olimpia | 12 | 413,83 |
| 001 171 330001 03 00 | Üçlü Ups Grup Priz (3Mt) Olimpia | 12 | 492,05 |
| 001 171 330001 05 00 | Üçlü Ups Grup Priz (5Mt) Olimpia | 12 | 640,51 |
| 001 171 410001 00 00 | Dörtlü Topraklı Grup Priz (Klemensli) Olimpia | 25 | 196,91 |
| 001 171 410001 02 00 | Dörtlü Topraklı Grup Priz (2Mt) Olimpia | 12 | 359,46 |
| 001 171 410001 03 00 | Dörtlü Topraklı Grup Priz (3Mt) Olimpia | 12 | 429,69 |
| 001 171 410001 05 00 | Dörtlü Topraklı Grup Priz (5Mt) Olimpia | 12 | 549,12 |
| 001 171 410002 00 00 | Dörtlü Topraklı Grup Priz (Klemensli-Anah. Olimpia) | 25 | 375,28 |
| 001 171 410002 02 00 | Dörtlü Topraklı Grup Priz (Anahtarlı 2 Mt) Olimpia | 12 | 518,89 |
| 001 171 410002 03 00 | Dörtlü Topraklı Grup Priz (Anahtarlı 3 Mt) Olimpia | 12 | 595,02 |
| 001 171 410002 05 00 | Dörtlü Topraklı Grup Priz (Anahtarlı 5 Mt) Olimpia | 12 | 703,87 |
| 001 171 610001 00 00 | Altılı Grup Priz Topraklı (Klemensli) Olimpia | 25 | 268,28 |
| 001 171 610001 02 00 | Altılı Topraklı Grup Priz (2 Mt) Olimpia | 12 | 501,21 |
| 001 171 610001 03 00 | Altılı Topraklı Grup Priz (3 Mt) Olimpia | 12 | 596,51 |
| 001 171 610001 05 00 | Altılı Topraklı Grup Priz (5 Mt) Olimpia | 12 | 775,16 |
| 001 171 610002 00 00 | Altılı Topraklı Grup Priz (Klemensli-Anahtarlı) Olimpia | 25 | 468,63 |
| 001 171 610002 02 00 | Altılı Topraklı Grup Priz (Anahtarlı 2 Mt) Olimpia | 12 | 646,25 |
| 001 171 610002 03 00 | Altılı Topraklı Grup Priz (Anahtarlı 3 Mt) Olimpia | 12 | 734,03 |
| 001 171 610002 05 00 | Altılı Topraklı Grup Priz (Anahtarlı 5 Mt) Olimpia | 12 | 932,05 |
| 001 170 110001 00 00 | 10'lu Topraklı Grup Priz (Klemensli) | 20 | 1.102,64 |

Olimpiā Fiş Prizler

Ürün Listesi



CE

| | |
|------------|---------------------------------------|
| Ürün Kodu | 001 170 012001 00 00 |
| Ürün Adı | Olimpia Topraklı Erkek Fiş (Kuyruklu) |
| Kutu Adedi | 50 |
| Fiyatı | 72,22 ₺ |



CE

| | |
|------------|----------------------|
| Ürün Kodu | 001 170 010001 00 00 |
| Ürün Adı | Olimpia Erkek Fiş |
| Kutu Adedi | 50 |
| Fiyatı | 55,56 ₺ |



CE

| | |
|------------|---|
| Ürün Kodu | 001 170 013001 00 00 |
| Ürün Adı | Olimpia Topraklı Erkek Fiş Ups (Kuyruklu) |
| Kutu Adedi | 50 |
| Fiyatı | 77,78 ₺ |



CE

| | |
|------------|----------------------|
| Ürün Kodu | 001 170 020001 00 00 |
| Ürün Adı | Olimpia Dişi Fiş |
| Kutu Adedi | 50 |
| Fiyatı | 38,61 ₺ |



CE

| | |
|------------|----------------------------|
| Ürün Kodu | 001 170 011001 00 00 |
| Ürün Adı | Olimpia Topraklı Erkek Fiş |
| Kutu Adedi | 50 |
| Fiyatı | 69,44 ₺ |



CE

| | |
|------------|---------------------------|
| Ürün Kodu | 001 170 021001 00 00 |
| Ürün Adı | Olimpia Topraklı Dişi Fiş |
| Kutu Adedi | 25 |
| Fiyatı | 63,91 ₺ |



CE

| | |
|------------|--------------------------------|
| Ürün Kodu | 001 170 014001 00 00 |
| Ürün Adı | Olimpia Topraklı Erkek Fiş Ups |
| Kutu Adedi | 50 |
| Fiyatı | 75,00 ₺ |



CE

| | |
|------------|------------------------------|
| Ürün Kodu | 001 888 000001 00 00 |
| Ürün Adı | Prizmatik Priz Koruma Kapağı |
| Kutu Adedi | 100 |
| Fiyatı | 31,11 ₺ |



CE

| | |
|------------|---|
| Ürün Kodu | 001 170 033006 00 00 |
| Ürün Adı | Olimpia ikili Topraklı Fiş-Priz (Düz Tip Beyaz) |
| Kutu Adedi | 28 |
| Fiyatı | 163,79 ₺ |



CE

| | |
|------------|---|
| Ürün Kodu | 001 170 033007 00 00 |
| Ürün Adı | Olimpia ikili Topraklı Fiş-Priz (Düz Tip Beyaz Anahtarlı) |
| Kutu Adedi | 28 |
| Fiyatı | 293,43 ₺ |



CE

| | |
|------------|---|
| Ürün Kodu | 001 170 033006 00 11 |
| Ürün Adı | Olimpia ikili Topraklı Fiş-Priz (Düz Tip Siyah) |
| Kutu Adedi | 28 |
| Fiyatı | 163,79 ₺ |



CE

| | |
|------------|---|
| Ürün Kodu | 001 170 033007 00 11 |
| Ürün Adı | Olimpia ikili Topraklı Fiş-Priz (Düz Tip Siyah Anahtarlı) |
| Kutu Adedi | 28 |
| Fiyatı | 293,43 ₺ |

Plus Fiş Prizler

Ürün Listesi



CE

| | |
|------------|-------------------------|
| Ürün Kodu | 001 170 051001 00 00 |
| Ürün Adı | Plus Topraklı Erkek Fiş |
| Kutu Adedi | 50/600 |
| Fiyatı | 67,47 ₺ |



CE

| | |
|------------|------------------------|
| Ürün Kodu | 001 170 061001 00 00 |
| Ürün Adı | Plus Topraklı Dişi Fiş |
| Kutu Adedi | 50 |
| Fiyatı | 75,90 ₺ |



| | |
|------------|----------------------|
| Ürün Kodu | 001 170 050001 00 00 |
| Ürün Adı | Plus Erkek Fiş |
| Kutu Adedi | 50/600 |
| Fiyatı | 46,38 ₺ |



CE

| | |
|------------|----------------------|
| Ürün Kodu | 001 170 060001 00 00 |
| Ürün Adı | Plus Dişi Fiş |
| Kutu Adedi | 50/600 |
| Fiyatı | 33,73 ₺ |



CE

| | |
|------------|--------------------------------|
| Ürün Kodu | 001 170 011002 00 00 |
| Ürün Adı | Plus Kulplu Topraklı Erkek Fiş |
| Kutu Adedi | 50 |
| Fiyatı | 69,58 ₺ |



| | |
|------------|--------------------------------------|
| Ürün Kodu | 001 170 030002 00 00 |
| Ürün Adı | Plus Adaptör Fiş, Priz (İngiliz Tip) |
| Kutu Adedi | 50/500 |
| Fiyatı | 92,09 ₺ |



CE

| | |
|------------|---|
| Ürün Kodu | 001 170 033001 00 00 |
| Ürün Adı | Plus Topraklı Üçlü Fiş-Priz (Yonca Tip) (S/A) |
| Kutu Adedi | 12/144 |
| Fiyatı | 265,65 ₺ |



CE

| | |
|------------|---|
| Ürün Kodu | 001 170 033002 00 00 |
| Ürün Adı | Plus Topraklı Üçlü Fiş-Priz (Yonca Tip) (S/Ü) |
| Kutu Adedi | 36 |
| Fiyatı | 259,33 ₺ |



CE

| | |
|------------|--|
| Ürün Kodu | 001 170 033003 00 00 |
| Ürün Adı | Plus İkili Topraklı Fiş-Priz (Düz Tip) |
| Kutu Adedi | 48 |
| Fiyatı | 250,89 ₺ |



CE

| | |
|------------|---------------------------------------|
| Ürün Kodu | 001 170 033005 00 00 |
| Ürün Adı | Plus Üçlü Topraklı Fiş-Priz (Düz Tip) |
| Kutu Adedi | 40 |
| Fiyatı | 303,60 ₺ |



CE

| | |
|------------|----------------------|
| Ürün Kodu | 001 170 030001 00 00 |
| Ürün Adı | Plus Arapuar Anahtar |
| Kutu Adedi | 50/600 |
| Fiyatı | 36,90 ₺ |



CE

| | |
|------------|---|
| Ürün Kodu | 001 170 033004 00 00 |
| Ürün Adı | Plus Üçlü Topraklı Fiş-Priz (Düz Tip Anahtarlı) |
| Kutu Adedi | 36 |
| Fiyatı | 415,34 ₺ |

Plus Fiş Prizler

Ürün Listesi



CE

| | |
|------------|--------------------------------------|
| Ürün Kodu | 001 170 011002 00 11 |
| Ürün Adı | Plus Kulplu Topraklı Erkek Fiş Siyah |
| Kutu Adedi | 50 |
| Fiyatı | 69,58 ₺ |



CE

| | |
|------------|----------------------|
| Ürün Kodu | 001 170 050001 00 11 |
| Ürün Adı | Plus Erkek Fiş Siyah |
| Kutu Adedi | 50 |
| Fiyatı | 46,38 ₺ |



CE

| | |
|------------|-------------------------------|
| Ürün Kodu | 001 170 051001 00 11 |
| Ürün Adı | Plus Topraklı Erkek Fiş Siyah |
| Kutu Adedi | 50 |
| Fiyatı | 67,47 ₺ |



CE

| | |
|------------|----------------------|
| Ürün Kodu | 001 170 060001 00 11 |
| Ürün Adı | Plus Dişi Fiş Siyah |
| Kutu Adedi | 50 |
| Fiyatı | 33,73 ₺ |



CE

| | |
|------------|------------------------------|
| Ürün Kodu | 001 170 061001 00 11 |
| Ürün Adı | Plus Topraklı Dişi Fiş Siyah |
| Kutu Adedi | 50 |
| Fiyatı | 75,90 ₺ |



CE

| | |
|------------|----------------------------|
| Ürün Kodu | 001 170 030001 00 11 |
| Ürün Adı | Plus Arapuar Anahtar Siyah |
| Kutu Adedi | 50 |
| Fiyatı | 36,90 ₺ |



CE

| | |
|------------|---|
| Ürün Kodu | 001 170 033002 00 11 |
| Ürün Adı | Plus Topraklı Üçlü Fiş-Priz (Yonca Tip) Siyah |
| Kutu Adedi | 36 |
| Fiyatı | 259,33 ₺ |



CE

| | |
|------------|--|
| Ürün Kodu | 001 170 033003 00 11 |
| Ürün Adı | Plus İkili Topraklı Fiş-Priz Düz Tip Siyah |
| Kutu Adedi | 48 |
| Fiyatı | 250,89 ₺ |



CE

| | |
|------------|---|
| Ürün Kodu | 001 170 033005 00 11 |
| Ürün Adı | Plus Üçlü Topraklı Fiş-Priz (Düz Tip) Siyah |
| Kutu Adedi | 40 |
| Fiyatı | 303,60 ₺ |



CE

| | |
|------------|---|
| Ürün Kodu | 001 170 033004 00 11 |
| Ürün Adı | Plus Üçlü Topraklı Anahtarlı Fiş-Priz (Düz Tip) Siyah |
| Kutu Adedi | 36 |
| Fiyatı | 415,34 ₺ |



CE

| | |
|------------|--|
| Ürün Kodu | 001 170 030002 00 11 |
| Ürün Adı | Plus Adaptör Fiş, Priz (İngiliz Tip) Siyah |
| Kutu Adedi | 50 |
| Fiyatı | 92,09 ₺ |

KABLO KANALLARI, PLASTİK GRUBU,
TESİSAT GRUBU ve
AYDINLATMA GRUBU

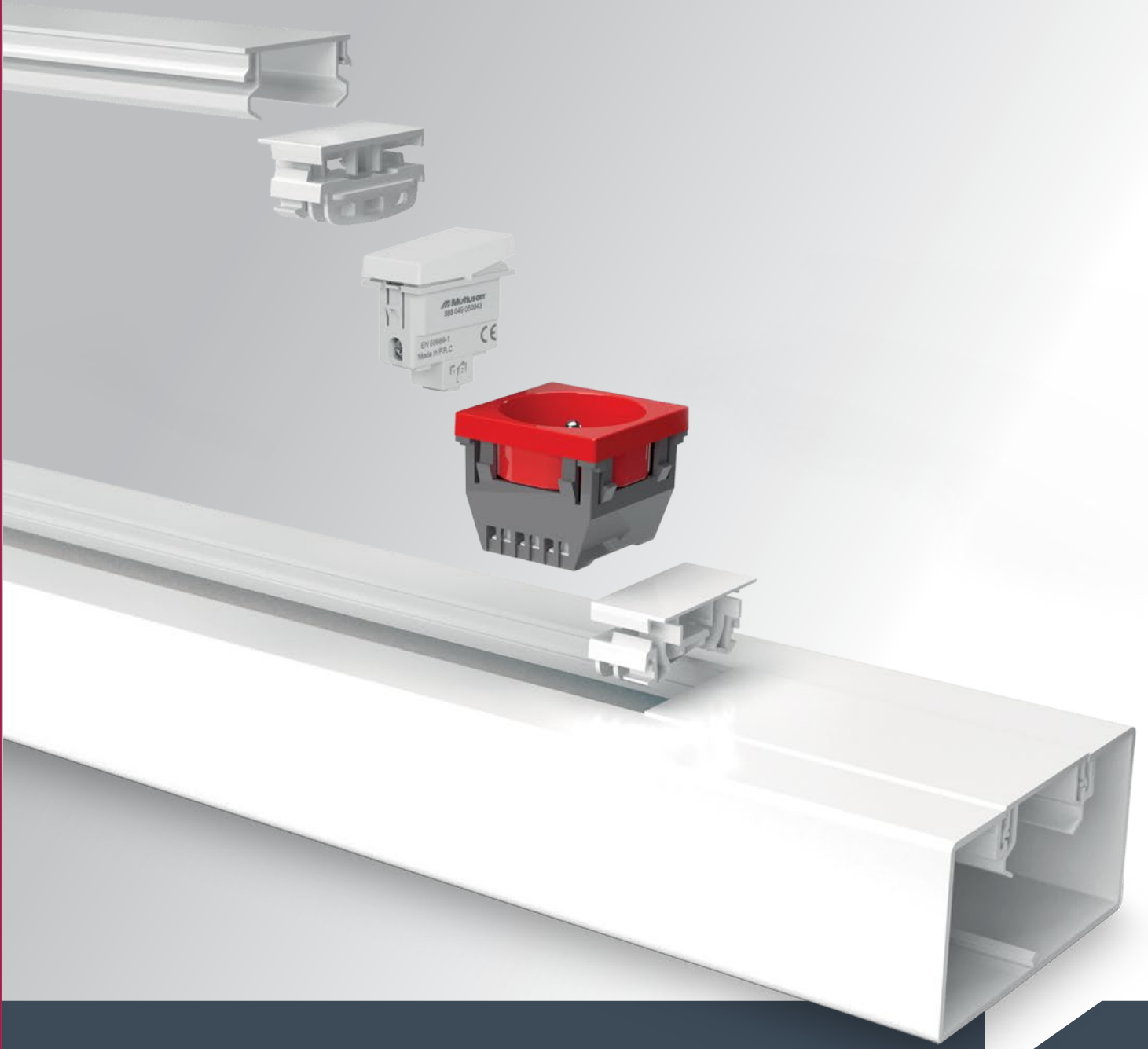

UÇ TAPA



T KÖŞE



İÇ KÖŞE



EK PARÇA



DIŞ KÖŞE



L KÖŞE

KABLO KANALLARI ve AKSESUARLARI

YENİ PRİZ MONTAJ SETLERİMİZ YENİ TIRNAK YAPISI İLE DAHA SAĞLAM DAHA GÜVENLİ

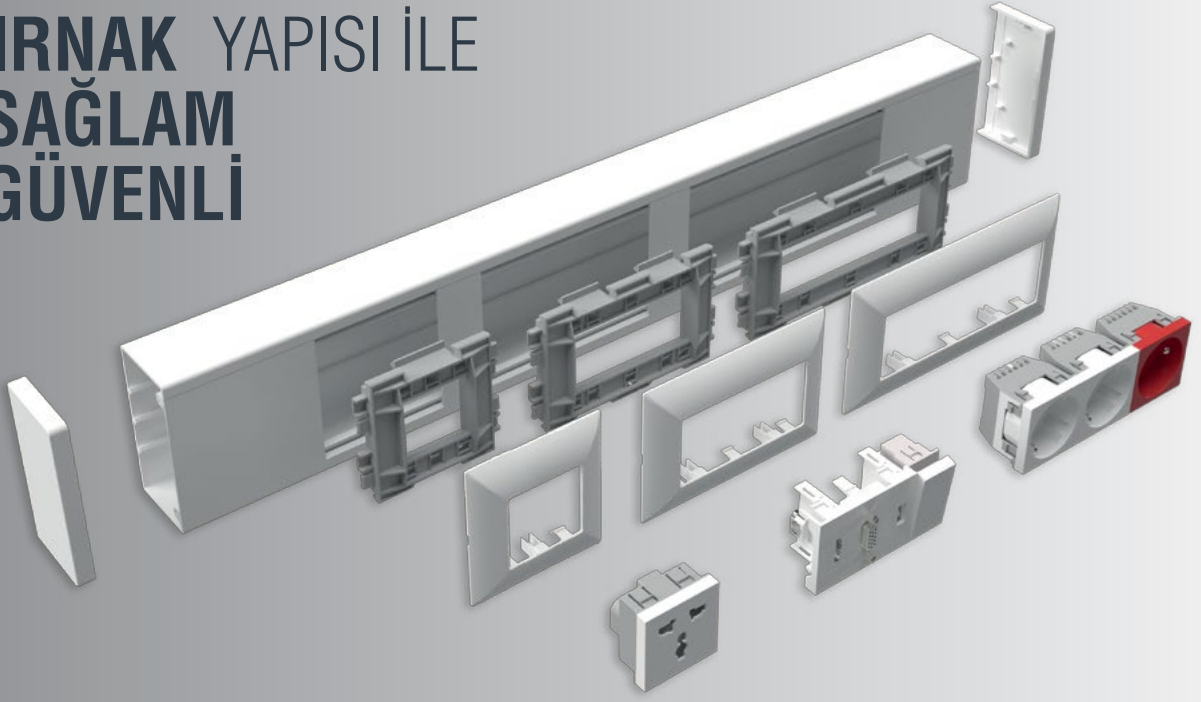

“Ofisinizde, evinizde düzensiz kablo karmaşasını düzenlemek için her zaman iyi bir seçimdir.”

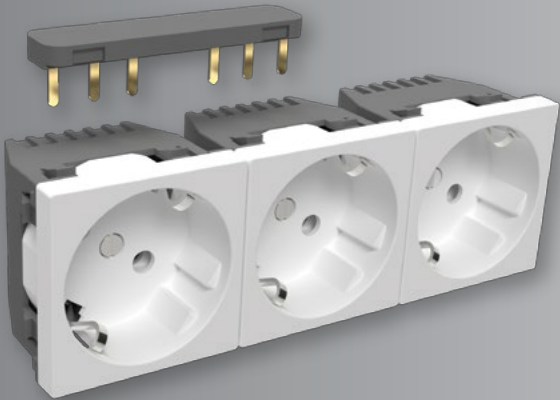

| Ürün Kodu | Ürün Adı | Amb. (Kutu) | Amb. Birimi | Fiyat (₺) |
|--|--|-------------|-------------|-----------|
| LED İÇİN KENDİNDEN KAPAKLI KABLO KANALI | | | | |
| 001 004 013012 20 44 | 13x12,5 MM KABLO KANALI ŞEFFAF KANAL (LED İÇİN) | 300 | mt. | 52,70 |
| CANALEX SERİSİ TSE'Lİ KAPALI TİP KABLO KANALLARI (KUTULU) | | | | |
| 001 156 012012 20 00 | 12x12 MM KABLO KANALI (CANALEX) | 250 | mt. | 14,40 |
| 001 156 015010 20 00 | 15x10 MM KABLO KANALI (CANALEX) | 250 | mt. | 15,30 |
| 001 156 016016 20 00 | 16x16 MM KABLO KANALI (CANALEX) | 250 | mt. | 17,10 |
| 001 156 020010 20 00 | 20x10 MM KABLO KANALI (CANALEX) | 200 | mt. | 17,70 |
| 001 156 020015 20 00 | 20x15 MM KABLO KANALI (CANALEX) | 200 | mt. | 25,30 |
| 001 156 025016 20 00 | 25x16 MM KABLO KANALI (CANALEX) | 150 | mt. | 26,20 |
| 001 156 025025 20 00 | 25x25 MM KABLO KANALI (CANALEX) | 100 | mt. | 35,60 |
| 001 156 040016 20 00 | 40x16 MM KABLO KANALI (CANALEX) | 100 | mt. | 43,40 |
| 001 156 040025 20 00 | 40x25 MM KABLO KANALI (CANALEX) | 80 | mt. | 48,50 |
| 001 156 040040 20 00 | 40x40 MM KABLO KANALI (CANALEX) | 50 | mt. | 61,90 |
| 001 156 060040 20 00 | 60x40 MM KABLO KANALI (CANALEX) | 40 | mt. | 89,00 |
| 001 156 060060 20 00 | 60x60 MM KABLO KANALI (CANALEX) | 32 | mt. | 136,70 |
| 001 156 080040 20 00 | 80x40 MM KABLO KANALI (CANALEX) | 30 | mt. | 138,50 |
| 001 156 080060 20 00 | 80x60 MM KABLO KANALI (CANALEX) | 24 | mt. | 163,80 |
| 001 156 100040 20 00 | 100x40 MM KABLO KANALI (CANALEX) | 24 | mt. | 170,10 |
| 001 156 100060 20 00 | 100x60 MM KABLO KANALI (CANALEX) | 20 | mt. | 238,40 |
| CANALEX SERİSİ KAPALI TİP KABLO KANALLARI (YAPIŞKAN BANTLI) | | | | |
| 001 157 012012 20 00 | 12x12 MM KABLO KANALI CANALEX (YAPIŞKAN BANTLI) | 250 | mt. | 17,20 |
| 001 157 015010 20 00 | 15x10 MM KABLO KANALI CANALEX (YAPIŞKAN BANTLI) | 230 | mt. | 17,90 |
| 001 157 016016 20 00 | 16x16 MM KABLO KANALI CANALEX (YAPIŞKAN BANTLI) | 240 | mt. | 20,90 |
| 001 157 020010 20 00 | 20x10 MM KABLO KANALI CANALEX (YAPIŞKAN BANTLI) | 200 | mt. | 21,10 |
| 001 157 020015 20 00 | 20x15 MM KABLO KANALI CANALEX (YAPIŞKAN BANTLI) | 180 | mt. | 30,80 |
| 001 157 025016 20 00 | 25x16 MM KABLO KANALI CANALEX (YAPIŞKAN BANTLI) | 150 | mt. | 32,20 |
| 001 157 025025 20 00 | 25x25 MM KABLO KANALI CANALEX (YAPIŞKAN BANTLI) | 100 | mt. | 42,30 |
| 001 157 040016 20 00 | 40x16 MM KABLO KANALI CANALEX (YAPIŞKAN BANTLI) | 100 | mt. | 54,20 |
| 001 157 040025 20 00 | 40x25 MM KABLO KANALI CANALEX (YAPIŞKAN BANTLI) | 80 | mt. | 60,00 |
| 001 157 040040 20 00 | 40x40 MM KABLO KANALI CANALEX (YAPIŞKAN BANTLI) | 50 | mt. | 75,40 |
| 001 157 060040 20 00 | 60x40 MM KABLO KANALI CANALEX (YAPIŞKAN BANTLI) | 40 | mt. | 104,50 |
| EKO SERİSİ TSE'Lİ KAPALI TİP KABLO KANALLARI | | | | |
| 001 014 010008 20 00 | 10x08 MM KABLO KANALI EKO | 330 | mt. | 15,60 |
| 001 014 012012 20 00 | 12x12 MM KABLO KANALI EKO | 250 | mt. | 16,60 |
| 001 014 015010 20 00 | 15x10 MM KABLO KANALI EKO | 250 | mt. | 16,90 |
| 001 014 015015 20 00 | 15x15 MM KABLO KANALI EKO | 250 | mt. | 23,70 |
| 001 014 016016 20 00 | 16x16 MM KABLO KANALI EKO | 250 | mt. | 25,60 |
| 001 014 020010 20 00 | 20x10 MM KABLO KANALI EKO | 200 | mt. | 20,80 |
| 001 014 025016 20 00 | 25x16 MM KABLO KANALI EKO | 150 | mt. | 32,90 |
| 001 014 025025 20 00 | 25x25 MM KABLO KANALI EKO | 100 | mt. | 43,10 |
| 001 014 025040 20 00 | 25x40 MM KABLO KANALI EKO | 80 | mt. | 83,30 |
| 001 014 930010 20 00 | 30x10 MM KABLO KANALI EKO (BÖLMELİ) | 140 | mt. | 43,10 |
| 001 014 030015 20 00 | 30x15 MM KABLO KANALI EKO | 140 | mt. | 37,80 |
| 001 014 930016 20 00 | 30x16 MM KABLO KANALI EKO (BÖLMELİ) | 140 | mt. | 51,20 |
| 001 014 030016 20 00 | 30x16 MM KABLO KANALI EKO | 140 | mt. | 44,30 |
| 001 014 030025 20 00 | 30x25 MM KABLO KANALI EKO | 80 | mt. | 62,90 |
| 001 014 030030 20 00 | 30x30 MM KABLO KANALI EKO | 80 | mt. | 58,10 |
| 001 014 940016 20 00 | 40x16 MM KABLO KANALI EKO (BÖLMELİ) | 100 | mt. | 63,50 |
| 001 014 040016 20 00 | 40x16 MM KABLO KANALI EKO | 100 | mt. | 49,20 |
| 001 014 040025 20 00 | 40x25 MM KABLO KANALI EKO | 80 | mt. | 65,60 |
| 001 014 040040 20 00 | 40x40 MM KABLO KANALI EKO | 50 | mt. | 72,70 |
| 001 014 040060 20 00 | 40x60 MM KABLO KANALI EKO | 40 | mt. | 162,50 |
| 001 014 960025 20 00 | 60x25 MM KABLO KANALI EKO (BÖLMELİ) | 40 | mt. | 111,20 |
| 001 014 060040 20 00 | 60x40 MM KABLO KANALI EKO | 40 | mt. | 119,10 |
| 001 014 050050 20 00 | 50x50 MM KABLO KANALI EKO | 30 | mt. | 141,20 |
| 001 014 060060 20 00 | 60x60 MM KABLO KANALI EKO | 32 | mt. | 157,80 |
| 001 014 075075 20 00 | 75x75 MM KABLO KANALI EKO | 28 | mt. | 233,40 |
| 001 014 080040 20 00 | 80x40 MM KABLO KANALI EKO | 30 | mt. | 177,30 |
| 001 014 080060 20 00 | 80x60 MM KABLO KANALI EKO | 24 | mt. | 196,90 |
| 001 014 100040 20 00 | 100x40 MM KABLO KANALI EKO (PRİZ SETİ TAKILABİLİR) | 24 | mt. | 200,00 |
| 001 014 100037 20 00 | 100x37 MM KABLO KANALI İÇTEN KAPAKLI KANAL EKO FOLYOLU (PRİZ SETİ TAKILABİLİR) | 30 | mt. | 223,90 |
| 001 014 100050 20 00 | 100x50 MM KABLO KANALI İÇTEN KAPAKLI KANAL EKO FOLYOLU (PRİZ SETİ TAKILABİLİR) | 20 | mt. | 224,40 |
| 001 014 100060 20 00 | 100x60 MM KABLO KANALI EKO (PRİZ SETİ TAKILABİLİR) | 20 | mt. | 257,90 |
| 001 014 120060 20 00 | 120x60 MM KABLO KANALI EKO | 16 | mt. | 379,80 |
| 001 014 100100 20 00 | 100x100 MM KABLO KANALI EKO | 20 | mt. | 453,50 |
| EKO SERİSİ KAPALI TİP KABLO KANALLARI (YAPIŞKAN BANTLI) | | | | |
| 001 004 009005 20 00 | 9x5 MM KABLO KANALI KEN.KAPAKLI | 500 | mt. | 23,70 |
| 001 004 010007 20 44 | 9,5x7 MM KABLO KANALI ŞEFFAF KANAL | 500 | mt. | 33,70 |
| 001 004 012007 20 00 | 12x7,5 MM KABLO KANALI KENDİNDEN KAPAKLI | 350 | mt. | 24,80 |
| 001 004 013012 20 00 | 13x12,5 MM KABLO KANALI KENDİNDEN KAPAKLI | 300 | mt. | 30,40 |
| 001 004 010008 20 00 | 10x8 MM KABLO KANALI EKO (YAPIŞKAN BANTLI) | 330 | mt. | 17,20 |
| 001 004 010010 20 00 | 10x10 MM KABLO KANALI EKO KENDİNDEN KAPAKLI (YAPIŞKAN BANTLI) | 320 | mt. | 25,10 |
| 001 004 012012 20 00 | 12x12 MM KABLO KANALI EKO (YAPIŞKAN BANTLI) | 250 | mt. | 19,40 |
| 001 004 015010 20 00 | 15x10 MM KABLO KANALI EKO (YAPIŞKAN BANTLI) | 230 | mt. | 20,40 |
| 001 004 016016 20 00 | 16x16 MM KABLO KANALI EKO (YAPIŞKAN BANTLI) | 240 | mt. | 27,70 |
| 001 004 020010 20 00 | 20x10 MM KABLO KANALI EKO (YAPIŞKAN BANTLI) | 180 | mt. | 24,20 |
| 001 004 025016 20 00 | 25x16 MM KABLO KANALI EKO (YAPIŞKAN BANTLI) | 150 | mt. | 39,00 |
| 001 004 025025 20 00 | 25x25 MM KABLO KANALI EKO (YAPIŞKAN BANTLI) | 100 | mt. | 48,30 |
| 001 004 025040 20 00 | 25x40 MM KABLO KANALI EKO (YAPIŞKAN BANTLI) | 80 | mt. | 89,40 |
| 001 004 930010 20 00 | 30x10 MM KABLO KANALI EKO (YAPIŞKAN BANTLI) (BÖLMELİ) | 140 | mt. | 47,70 |
| 001 004 030016 20 00 | 30x16 MM KABLO KANALI EKO (YAPIŞKAN BANTLI) | 140 | mt. | 49,40 |
| 001 004 030025 20 00 | 30x25 MM KABLO KANALI EKO (YAPIŞKAN BANTLI) | 80 | mt. | 66,50 |
| 001 004 040016 20 00 | 40x16 MM KABLO KANALI EKO (YAPIŞKAN BANTLI) | 100 | mt. | 56,60 |
| 001 004 040025 20 00 | 40x25 MM KABLO KANALI EKO (YAPIŞKAN BANTLI) | 80 | mt. | 80,40 |
| 001 004 040040 20 00 | 40x40 MM KABLO KANALI EKO (YAPIŞKAN BANTLI) | 50 | mt. | 86,40 |
| 001 004 060040 20 00 | 60x40 MM KABLO KANALI EKO (YAPIŞKAN BANTLI) | 40 | mt. | 130,60 |

YENİ

LED
İÇİN ÖZEL
13x12,5mm



Kendinden Kapaklı
Intrinsic Cover

Kendinden Yapışkanlı
Self-Adhesive

Kendinden Yapışkanlı
Self-Adhesive



| Ürün Kodu | Ürün Adı | Amb. (Kutu) | Amb. Birimi | Fiyat (₺) |
|---|---|-------------|-------------|-----------|
| MEKS SERİSİ TSE'Lİ KAPALI TİP KABLO KANALLARI | | | | |
| TSE CE IP40 | | | | |
| 001 002 015015 20 00 | 15x15 MM KABLO KANALI MEKS | 250 | mt. | 28,50 |
| 001 002 016016 20 00 | 16x16 MM KABLO KANALI MEKS | 250 | mt. | 31,70 |
| 001 002 025016 20 00 | 25x16 MM KABLO KANALI MEKS | 150 | mt. | 42,40 |
| 001 002 025025 20 00 | 25x25 MM KABLO KANALI MEKS | 100 | mt. | 56,40 |
| 001 002 030015 20 00 | 30x15 MM KABLO KANALI MEKS | 140 | mt. | 53,10 |
| 001 002 030030 20 00 | 30x30 MM KABLO KANALI MEKS | 80 | mt. | 71,20 |
| 001 002 040017 20 00 | 40x17 MM KABLO KANALI TAM KAPAKLI MEKS | 100 | mt. | 75,40 |
| 001 002 940017 20 00 | 40x17 MM KABLO KANALI TAM KAPAKLI MEKS (BÖLMELİ) | 100 | mt. | 82,30 |
| 001 002 040025 20 00 | 40x25 MM KABLO KANALI MEKS | 80 | mt. | 78,40 |
| 001 002 040040 20 00 | 40x40 MM KABLO KANALI MEKS | 50 | mt. | 91,40 |
| 001 002 960025 20 00 | 60x25 MM KABLO KANALI MEKS (BÖLMELİ) | 40 | mt. | 123,80 |
| 001 002 060040 20 00 | 60x40 MM KABLO KANALI MEKS | 40 | mt. | 122,90 |
| 001 002 080060 20 00 | 80x60 MM KABLO KANALI MEKS | 24 | mt. | 206,30 |
| 001 002 100040 20 00 | 100x40 MM KABLO KANALI MEKS (PRİZ SETİ TAKILABİLİR) | 24 | mt. | 259,00 |
| 001 002 100048 20 00 | 100x48 MM KABLO KANALI MEKS (PRİZ SETİ TAKILABİLİR) | 24 | mt. | 334,50 |
| 001 002 100060 20 00 | 100x60 MM KABLO KANALI MEKS (PRİZ SETİ TAKILABİLİR) | 20 | mt. | 333,60 |
| 001 002 120060 20 00 | 120x60 MM KABLO KANALI MEKS | 16 | mt. | 417,90 |
| MEKS SERİSİ İÇTEN KAPAKLI KAPALI TİP KABLO KANALLARI | | | | |
| TSE CE IP40 | | | | |
| 001 002 100037 20 00 | 100x37 MM KABLO KANALI MEKS (İÇTEN KAPAKLI)(FOLYOLU) | 30 | mt. | 294,20 |
| 001 002 100041 20 00 | 100x41 MM KABLO KANALI MEKS (İÇTEN KAPAKLI)(FOLYOLU) | 24 | mt. | 290,30 |
| 001 002 100050 20 00 | 100x50 MM KABLO KANALI MEKS (İÇTEN KAPAKLI)(FOLYOLU) | 20 | mt. | 304,90 |
| 001 002 120070 20 00 | 120x70 MM KABLO KANALI (İÇTEN KAPAKLI)(AKSESUARLARI) | 16 | mt. | 458,90 |
| 001 002 170070 20 00 | 170x70 MM KABLO KANALI (İÇTEN KAPAKLI)(AKSESUARLARI) | 12 | mt. | 611,90 |
| 001 002 250070 20 00 | 250x70 MM KABLO KANALI (İÇTEN KAPAKLI)(AKSESUARLARI) | 8 | mt. | 956,70 |
| MEKSPUS SERİSİ KAPALI TİP KABLO KANALLARI | | | | |
| TSE CE IP40 | | | | |
| 001 003 100037 20 00 | 100x37 MM KABLO KANALI (İÇTEN KAPAKLI) | 30 | mt. | 302,00 |
| 001 003 100041 20 00 | 100x41 MM KABLO KANALI (İÇTEN KAPAKLI) | 24 | mt. | 306,20 |
| 001 003 100050 20 00 | 100x50 MM KABLO KANALI (İ. KAP.)(ET KALINLIĞI 2MM) | 20 | mt. | 367,20 |
| 001 006 100050 20 00 | 100x50 MM KABLO KANALI (İÇTEN KAPAKLI)(KAİDESİZ SERİ) | 20 | mt. | 393,10 |
| 001 003 120070 20 00 | 120x70 MM KABLO KANALI (İÇTEN KAPAKLI)(AKSESUARLARI) | 16 | mt. | 534,90 |
| 001 003 170050 20 00 | 170x50 MM KABLO KANALI (İÇTEN KAPAKLI) | 12 | mt. | 692,40 |
| 001 003 170070 20 00 | 170x70 MM KABLO KANALI (İÇTEN KAPAKLI)(AKSESUARLARI) | 12 | mt. | 834,20 |
| 001 003 250070 20 00 | 250x70 MM KABLO KANALI (İÇTEN KAPAKLI)(AKSESUARLARI) | 8 | mt. | 1.049,50 |
| MEKS SERİSİ KLİMA KANALI ve AKSESUARLARI | | | | |
| TSE CE IP40 | | | | |
| 001 002 075060 20 00 | 75x60 MM KLİMA KANALI | 30 | mt. | 198,00 |
| 001 050 030002 00 00 | KLİMA KANALI KABLO TUTUCUSU | 60 | ad. | 27,80 |
| 001 043 075060 00 00 | KLİMA KANALI EK PARÇASI | 40 | ad. | 27,80 |
| 001 039 075060 00 00 | KLİMA KANALI İÇ KÖŞE | 24 | ad. | 59,30 |
| 001 040 075060 00 00 | KLİMA KANALI DIŞ KÖŞE | 24 | ad. | 59,30 |
| 001 042 075060 00 00 | KLİMA KANALI L KÖŞE | 18 | ad. | 59,30 |
| 001 050 030001 00 00 | KLİMA KANALI DUVAR GEÇİŞİ | 60 | ad. | 37,00 |
| 001 044 075060 01 00 | KLİMA KANALI İÇ SONLAMA | 30 | ad. | 59,30 |
| 001 044 075060 02 00 | KLİMA KANALI DIŞ SONLAMA | 18 | ad. | 59,30 |
| TAVAN KÖŞE KANALI (23x23) ve AKSESUARLARI | | | | |
| TSE CE IP40 | | | | |
| 001 002 023023 20 00 | 23x23 MM TAVAN KÖŞE KANALI | 120 | mt. | 77,60 |
| 001 041 023023 00 00 | 23x23 MM T PARÇASI | 60 | ad. | 18,50 |
| 001 042 023023 00 00 | 23x23 MM 90 L KÖŞE | 60 | ad. | 18,50 |
| 001 043 023023 00 00 | 23x23 MM EK PARÇA | 100 | ad. | 14,80 |
| 001 044 023023 00 00 | 23x23 MM UÇ TAPA | 100 | ad. | 14,80 |
| SÜPÜRGELİK KABLO KANALLARI ve AKSESUARLARI | | | | |
| 001 010 000200 20 00 | 50'LİK FUGALI SÜPÜRGELİK | 60 | mt. | 72,20 |
| 001 014 974020 20 00 | 74x20 MM KABLO KANALI EKO (BÖLMELİ) | 50 | mt. | 158,00 |
| 001 039 074020 00 00 | 74x20 İÇ KÖŞE | 20 | ad. | 44,40 |
| 001 040 074020 00 00 | 74x20 DIŞ KÖŞE | 20 | ad. | 44,40 |
| 001 041 074020 00 00 | 74x20 T KÖŞE | 30 | ad. | 51,90 |
| 001 042 074020 01 00 | 74x90 20 L KÖŞE | 40 | ad. | 51,90 |
| 001 043 074020 00 00 | 74x20 EK PARÇA | 50 | ad. | 24,10 |
| 001 044 074020 00 00 | 74x20 UÇ TAPA | 50 | ad. | 24,10 |
| 001 047 017420 00 00 | 74x20 PRİZ MONTAJ KASASI | 6 | ad. | 140,70 |
| 001 047 017421 00 00 | 74x20 1'Lİ PRİZ MONTAJ KASASI | 12 | ad. | 263,50 |
| 001 002 975022 20 00 | 75x22 MM KABLO KANALI (BÖLMELİ) | 50 | mt. | 214,80 |
| 001 039 075022 00 00 | 75x22 MM İÇ KÖŞE | 20 | ad. | 22,20 |
| 001 040 075022 00 00 | 75x22 MM DIŞ KÖŞE | 20 | ad. | 22,20 |
| 001 044 075022 01 00 | 75x22 MM SAĞ SONLAMA | 30 | ad. | 34,10 |
| 001 044 075022 02 00 | 75x22 MM SOL SONLAMA | 20 | ad. | 33,50 |
| 001 043 075022 00 00 | 75x22 MM EK PARÇASI | 100 | ad. | 30,70 |
| TEZGAH SÜPÜRGELİĞİ | | | | |
| 001 011 000100 00 00 | 25'LİK TEZGAH SÜPÜRGELİĞİ 100CM | 60 | mt. | 83,40 |
| BALIK SIRTI KANALLARI | | | | |
| 001 002 050013 20 17 | 50x13 MM BALIK SIRTI KANAL (ZEMİN İÇİN) | 60 | mt. | 89,90 |
| 001 002 060015 20 17 | 60x15 MM BALIK SIRTI KANAL (ZEMİN İÇİN) | 40 | mt. | 102,80 |
| 001 002 075018 20 17 | 75x18 MM BALIK SIRTI KANAL (ZEMİN İÇİN) | 30 | mt. | 173,20 |
| 001 002 090020 20 17 | 90x20 MM BALIK SIRTI KANAL (ZEMİN İÇİN) | 20 | mt. | 223,10 |
| 001 004 050013 20 17 | 50x13 MM KABLO KANALI BALIK SIRTI (YAPIŞKAN BANTLI) | 60 | mt. | 103,20 |
| 001 004 060015 20 17 | 60x15 MM KABLO KANALI BALIK SIRTI (YAPIŞKAN BANTLI) | 40 | mt. | 114,10 |
| 001 004 075018 20 17 | 75x18 MM KABLO KANALI BALIK SIRTI (YAPIŞKAN BANTLI) | 30 | mt. | 193,20 |
| 001 004 090020 20 17 | 90x20 MM KABLO KANALI BALIK SIRTI (YAPIŞKAN BANTLI) | 20 | mt. | 245,70 |

| Ürün Kodu | Ürün Adı | Amb. (Kutu) | Amb. Birimi | Fiyat (₺) |
|--|---|-------------|-------------|-----------|
| H.FREE FLARET SERİSİ KAPALI TİP KABLO KANALLARI | | | | |
| 001 060 100050 20 00 | 100x50 MM KABLO KANALI İÇTEN KAPAKLI HALOJEN FREE | 20 | mt. | 939,50 |
| 001 061 100050 20 00 | 100x50 MM KABLO KANALI ARA BÖLME HALOJEN FREE | 150 | mt. | 118,60 |
| 001 039 100050 11 00 | 100x50-37 MM KABLO KANALI İÇ KÖŞE(HAREKETLİ) HALOJEN FREE | 12 | ad. | 92,60 |
| 001 040 100050 11 00 | 100x50 MM KABLO KANALI DIŞ KÖŞE(HAREKETLİ) HALOJEN FREE | 10 | ad. | 92,60 |
| 001 041 100050 11 00 | 100x50 MM KABLO KANALI T PARÇASI HALOJEN FREE | 10 | ad. | 100,00 |
| 001 042 100050 11 00 | 100x50 MM KABLO KANALI 90 L KÖŞE HALOJEN FREE | 10 | ad. | 100,00 |
| 001 043 100050 11 00 | 100x50 MM KABLO KANALI EK PARÇA(ÜÇLÜ SET) HALOJEN FREE | 100 | ad. | 42,80 |
| 001 044 100050 11 00 | 100x50 MM KABLO KANALI UÇ TAPA HALOJEN FREE | 40 | ad. | 42,80 |
| 001 047 100001 11 00 | PMS(100x37/50)(45X45)(1LÜ) HALOJEN FREE | 30 | ad. | 63,50 |
| 001 047 100002 11 00 | PMS(100x37/50)(45X45)(2LÜ) HALOJEN FREE | 16 | ad. | 91,50 |
| 001 047 100003 11 00 | PMS(100x37/50)(45X45)(3LÜ) HALOJEN FREE | 14 | ad. | 129,60 |
| H.FREE FLARET SERİSİ KAPALI TİP KABLO KANALLARI | | | | |
| 001 060 025016 20 00 | 25x16 MM KABLO KANALI HALOJEN FREE | 150 | mt. | 173,00 |
| 001 060 025025 20 00 | 25x25 MM KABLO KANALI HALOJEN FREE | 100 | mt. | 188,90 |
| 001 060 040025 20 00 | 40x25 MM KABLO KANALI HALOJEN FREE | 80 | mt. | 278,30 |
| 001 060 040040 20 00 | 40x40 MM KABLO KANALI HALOJEN FREE | 50 | mt. | 317,80 |
| 25x16 H.FREE FLARET KANAL AKSESUARLARI | | | | |
| 001 039 025016 11 00 | 25x16 MM İÇ KÖŞE | 40 | ad. | 20,50 |
| 001 040 025016 11 00 | 25x16 MM DIŞ KÖŞE | 40 | ad. | 20,50 |
| 001 041 025016 11 00 | 25x16 MM T PARÇASI | 30 | ad. | 31,25 |
| 001 042 025016 11 00 | 25x16 MM 90 L KÖŞE | 80 | ad. | 31,25 |
| 001 043 025016 11 00 | 25x16 MM EK PARÇA | 100 | ad. | 18,75 |
| 001 044 025016 11 00 | 25x16 MM UÇ TAPA | 100 | ad. | 18,75 |
| 25x25 H.FREE FLARET KANAL AKSESUARLARI | | | | |
| 001 039 025025 11 00 | 25x25 MM İÇ KÖŞE | 40 | ad. | 22,75 |
| 001 040 025025 11 00 | 25x25 MM DIŞ KÖŞE | 40 | ad. | 22,75 |
| 001 041 025025 11 00 | 25x25 MM T PARÇASI | 30 | ad. | 38,00 |
| 001 042 025025 11 00 | 25x25 MM 90 L KÖŞE | 50 | ad. | 38,00 |
| 001 043 025025 11 00 | 25x25 MM EK PARÇA | 100 | ad. | 21,25 |
| 001 044 025025 11 00 | 25x25 MM UÇ TAPA | 100 | ad. | 21,25 |
| 40x25 H.FREE FLARET KANAL AKSESUARLARI | | | | |
| 001 039 040025 11 00 | 40x25 MM İÇ KÖŞE | 24 | ad. | 58,30 |
| 001 040 040025 11 00 | 40x25 MM DIŞ KÖŞE | 30 | ad. | 58,30 |
| 001 041 040025 11 00 | 40x25 MM T PARÇASI | 18 | ad. | 72,25 |
| 001 042 040025 11 00 | 40x25 MM 90 L KÖŞE | 24 | ad. | 72,25 |
| 001 043 040025 11 00 | 40x25 MM EK PARÇA | 70 | ad. | 44,12 |
| 001 044 040025 11 00 | 40x25 MM UÇ TAPA | 25 | ad. | 44,12 |
| 40x40 H.FREE FLARET KANAL AKSESUARLARI | | | | |
| 001 039 040040 11 00 | 40x40 MM İÇ KÖŞE | 18 | ad. | 64,00 |
| 001 040 040040 11 00 | 40x40 MM DIŞ KÖŞE | 16 | ad. | 64,00 |
| 001 041 040040 11 00 | 40x40 MM T PARÇASI | 48 | ad. | 66,13 |
| 001 042 040040 11 00 | 40x40 MM 90 L KÖŞE | 60 | ad. | 66,13 |
| 001 043 040040 11 00 | 40x40 MM EK PARÇA | 100 | ad. | 43,45 |
| 001 044 040040 11 00 | 40x40 MM UÇ TAPA | 25 | ad. | 43,45 |

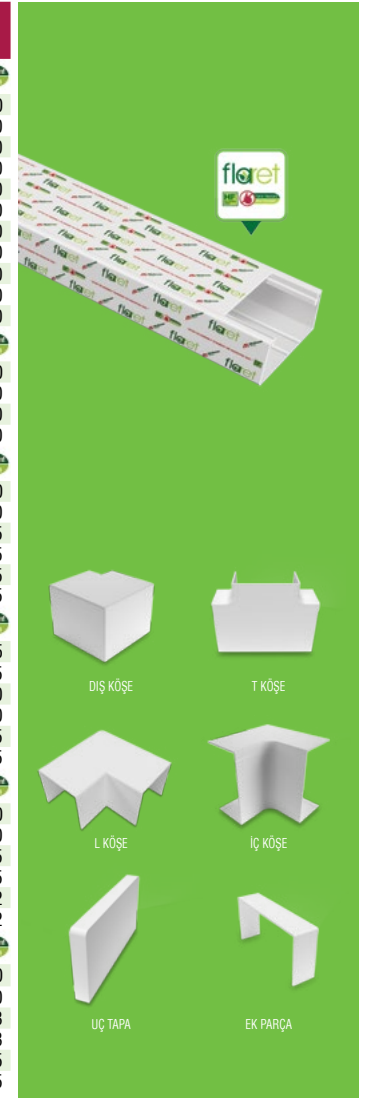



EK PARÇA



T KÖŞE



İÇ KÖŞE



DIŞ KÖŞE



L KÖŞE



UÇ TAPA

| Ürün Kodu | Ürün Adı | Amb. (Kutu) | Amb. Birimi | Fiyat (₺) |
|---------------------------------------|---|-------------|-------------|-----------|
| BALIK SIRTI 60x15 AKSESUARLARI | | | | |
| 001 042 060015 00 17 | 60x15 MM BALIK SIRTI KANAL L KÖŞE | 24 | ad. | 37,00 |
| 001 043 060015 00 17 | 60x15 MM BALIK SIRTI KANAL EK PARÇASI | 50 | ad. | 18,50 |
| 001 044 060015 00 17 | 60x15 MM BALIK SIRTI KANAL SONLAMA KAPAĞI | 50 | ad. | 18,50 |
| 001 041 060015 00 17 | 60x15 MM BALIK SIRTI KANAL T KÖŞE | 10 | ad. | 48,10 |
| BALIK SIRTI 75x18 AKSESUARLARI | | | | |
| 001 042 075018 00 17 | 75x18 MM BALIK SIRTI KANAL L KÖŞE | 15 | ad. | 55,60 |
| 001 043 075018 00 17 | 75x18 MM BALIK SIRTI KANAL EK PARÇASI | 50 | ad. | 22,20 |
| 001 044 075018 00 17 | 75x18 MM BALIK SIRTI KANAL SONLAMA KAPAĞI | 50 | ad. | 22,20 |
| 001 041 075018 00 17 | 75x18 MM BALIK SIRTI KANAL T KÖŞE | 8 | ad. | 55,60 |
| BALIK SIRTI 90x20 AKSESUARLARI | | | | |
| 001 042 090020 00 17 | 90x20 MM BALIK SIRTI KANAL KANAL L KÖŞE | 20 | ad. | 59,30 |
| 001 043 090020 00 17 | 90x20 MM BALIK SIRTI KANAL EK PARÇASI | 50 | ad. | 22,20 |
| 001 044 090020 00 17 | 90x20 MM BALIK SIRTI KANAL SONLAMA KAPAĞI | 50 | ad. | 22,20 |
| 001 041 090020 00 17 | 90x20 MM BALIK SIRTI KANAL T KÖŞE | 12 | ad. | 59,30 |
| 12X12 KANAL AKSESUARLARI | | | | |
| 001 039 012012 00 00 | 12x12 MM İÇ KÖŞE | 60 | ad. | 13,00 |
| 001 040 012012 00 00 | 12x12 MM DIŞ KÖŞE | 60 | ad. | 13,00 |
| 001 041 012012 00 00 | 12x12 MM T KÖŞE | 60 | ad. | 13,70 |
| 001 042 012012 00 00 | 12x12 MM 90 L KÖŞE | 60 | ad. | 13,70 |
| 001 044 012012 00 00 | 12x12 MM UÇ TAPA | 100 | ad. | 12,60 |
| 001 043 012012 00 00 | 12x12 MM EK PARÇASI | 100 | ad. | 12,60 |
| 15X10 KANAL AKSESUARLARI | | | | |
| 001 039 015010 00 00 | 15x10 MM İÇ KÖŞE | 60 | ad. | 14,10 |
| 001 040 015010 00 00 | 15x10 MM DIŞ KÖŞE | 60 | ad. | 14,10 |
| 001 041 015010 00 00 | 15x10 MM T KÖŞE | 60 | ad. | 14,80 |
| 001 042 015010 00 00 | 15x10 MM 90 L KÖŞE | 60 | ad. | 14,80 |
| 001 044 015010 00 00 | 15x10 MM UÇ TAPA | 100 | ad. | 13,30 |
| 001 043 015010 00 00 | 15x10 MM EK PARÇASI | 100 | ad. | 13,30 |
| 20X10 KANAL AKSESUARLARI | | | | |
| 001 039 020010 00 00 | 20x10 MM İÇ KÖŞE | 60 | ad. | 14,40 |
| 001 040 020010 00 00 | 20x10 MM DIŞ KÖŞE | 60 | ad. | 14,40 |
| 001 041 020010 00 00 | 20x10 MM T KÖŞE | 30 | ad. | 17,80 |
| 001 042 020010 00 00 | 20x10 MM 90 L KÖŞE | 50 | ad. | 17,80 |
| 001 044 020010 00 00 | 20x10 MM UÇ TAPA | 100 | ad. | 13,30 |
| 001 043 020010 00 00 | 20x10 MM EK PARÇASI | 100 | ad. | 13,30 |
| 16X16 KANAL AKSESUARLARI | | | | |
| 001 039 016016 00 00 | 16x16 MM İÇ KÖŞE | 100 | ad. | 15,90 |
| 001 040 016016 00 00 | 16x16 MM DIŞ KÖŞE | 100 | ad. | 15,90 |
| 001 041 016016 00 00 | 16x16 MM T KÖŞE | 60 | ad. | 19,10 |
| 001 042 016016 00 00 | 16x16 MM 90 L KÖŞE | 60 | ad. | 19,10 |
| 001 044 016016 00 00 | 16x16 MM UÇ TAPA | 100 | ad. | 14,10 |
| 001 043 016016 00 00 | 16x16 MM EK PARÇASI | 100 | ad. | 14,10 |
| 25X16 KANAL AKSESUARLARI | | | | |
| 001 039 025016 00 00 | 25x16 MM İÇ KÖŞE | 40 | ad. | 17,00 |
| 001 040 025016 00 00 | 25x16 MM DIŞ KÖŞE | 40 | ad. | 17,00 |
| 001 041 025016 00 00 | 25x16 MM T KÖŞE | 30 | ad. | 25,90 |
| 001 042 025016 00 00 | 25x16 MM 90 L KÖŞE | 80 | ad. | 25,90 |
| 001 044 025016 00 00 | 25x16 MM UÇ TAPA | 100 | ad. | 15,60 |
| 001 043 025016 00 00 | 25x16 MM EK PARÇASI | 100 | ad. | 15,60 |
| 001 047 017421 00 00 | 25x16 MM PMK (45x45) | 12 | ad. | 263,50 |
| 25X25 KANAL AKSESUARLARI | | | | |
| 001 039 025025 00 00 | 25x25 MM İÇ KÖŞE | 40 | ad. | 18,90 |
| 001 040 025025 00 00 | 25x25 MM DIŞ KÖŞE | 40 | ad. | 18,90 |
| 001 041 025025 00 00 | 25x25 MM T KÖŞE | 24 | ad. | 31,50 |
| 001 042 025025 00 00 | 25x25 MM 90 L KÖŞE | 40 | ad. | 31,50 |
| 001 044 025025 00 00 | 25x25 MM UÇ TAPA | 100 | ad. | 17,60 |
| 001 043 025025 00 00 | 25x25 MM EK PARÇASI | 50 | ad. | 17,60 |
| 001 047 017421 00 00 | 25x25 MM PMK (45x45) | 12 | ad. | 263,50 |
| 30X10 KANAL AKSESUARLARI | | | | |
| 001 039 030010 00 00 | 30x10 MM İÇ KÖŞE | 50 | ad. | 25,90 |
| 001 040 030010 00 00 | 30x10 MM DIŞ KÖŞE | 50 | ad. | 25,90 |
| 001 041 030010 00 00 | 30x10 MM T KÖŞE | 50 | ad. | 33,30 |
| 001 042 030010 00 00 | 30x10 MM 90 L KÖŞE | 50 | ad. | 33,30 |
| 001 044 030025 00 00 | 30x10-16-25 MM UÇ TAPA | 100 | ad. | 27,80 |
| 001 043 030025 00 00 | 30x10-16-25 MM EK PARÇASI | 100 | ad. | 27,80 |
| 30X16 KANAL AKSESUARLARI | | | | |
| 001 039 030016 00 00 | 30x16 MM İÇ KÖŞE | 35 | ad. | 44,40 |
| 001 040 030016 00 00 | 30x16 MM DIŞ KÖŞE | 48 | ad. | 44,40 |
| 001 041 030016 00 00 | 30x16 MM T KÖŞE | 40 | ad. | 48,10 |
| 001 042 030016 00 00 | 30x16 MM 90 L KÖŞE | 50 | ad. | 48,10 |
| 001 044 030025 00 00 | 30x10-16-25 MM UÇ TAPA | 100 | ad. | 27,80 |
| 001 043 030025 00 00 | 30x10-16-25 MM EK PARÇASI | 100 | ad. | 27,80 |
| 30X25 KANAL AKSESUARLARI | | | | |
| 001 039 030025 00 00 | 30x25 MM İÇ KÖŞE | 30 | ad. | 46,30 |
| 001 040 030025 00 00 | 30x25 MM DIŞ KÖŞE | 32 | ad. | 46,30 |
| 001 041 030025 00 00 | 30x25 MM T KÖŞE | 24 | ad. | 48,10 |
| 001 042 030025 00 00 | 30x25 MM 90 L KÖŞE | 30 | ad. | 48,10 |
| 001 044 030025 00 00 | 30x10-16-25 MM UÇ TAPA | 100 | ad. | 27,80 |
| 001 043 030025 00 00 | 30x10-16-25 MM EK PARÇASI | 100 | ad. | 27,80 |

| Ürün Kodu | Ürün Adı | Amb. (Kutu) | Amb. Birimi | Fiyat (₺) |
|----------------------------------|---|-------------|-------------|-----------|
| 40X16 KANAL AKSESUARLARI | | | | |
| ⚡ CE IP40 | | | | |
| 001 039 040016 00 00 | 40x16 MM İÇ KÖŞE | 32 | ad. | 35,20 |
| 001 040 040016 00 00 | 40x16 MM DIŞ KÖŞE | 30 | ad. | 35,20 |
| 001 041 040016 00 00 | 40x16 MM T KÖŞE | 24 | ad. | 40,70 |
| 001 042 040016 00 00 | 40x16 MM 90 L KÖŞE | 34 | ad. | 40,70 |
| 001 044 040040 00 00 | 40x16-25-40 MM UÇ TAPA | 25 | ad. | 32,20 |
| 001 043 040016 00 00 | 40x16-25-40 MM EK PARÇASI | 100 | ad. | 32,20 |
| 001 047 017421 00 00 | 40x165 MM PMK (45x45) | 12 | ad. | 263,50 |
| 40X25 KANAL AKSESUARLARI | | | | |
| ⚡ CE IP40 | | | | |
| 001 039 040025 00 00 | 40x25 MM İÇ KÖŞE | 24 | ad. | 38,10 |
| 001 040 040025 00 00 | 40x25 MM DIŞ KÖŞE | 30 | ad. | 38,10 |
| 001 041 040025 00 00 | 40x25 MM T KÖŞE | 18 | ad. | 42,60 |
| 001 042 040025 00 00 | 40x25 MM 90 L KÖŞE | 24 | ad. | 42,60 |
| 001 044 040040 00 00 | 40x16-25-40 MM UÇ TAPA | 25 | ad. | 32,20 |
| 001 043 040016 00 00 | 40x16-25-40 MM EK PARÇASI | 100 | ad. | 32,20 |
| 001 047 017421 00 00 | 40x25 MM PMK (45x45) | 12 | ad. | 263,50 |
| 40X40 KANAL AKSESUARLARI | | | | |
| ⚡ CE IP40 | | | | |
| 001 039 040040 01 00 | 40x40 MM İÇ KÖŞE (HAREKETLİ) | 18 | ad. | 38,90 |
| 001 040 040040 01 00 | 40x40 MM DIŞ KÖŞE (HAREKETLİ) | 16 | ad. | 38,90 |
| 001 041 040040 00 00 | 40x40 MM T KÖŞE | 48 | ad. | 44,40 |
| 001 042 040040 00 00 | 40x40 MM 90 L KÖŞE | 60 | ad. | 44,40 |
| 001 044 040040 00 00 | 40x16-25-40 MM UÇ TAPA | 50 | ad. | 32,20 |
| 001 043 040016 00 00 | 40x16-25-40 MM EK PARÇASI | 100 | ad. | 32,20 |
| 001 047 017421 00 00 | 40x40 MM PMK (45x45) | 12 | ad. | 263,50 |
| 60X25 KANAL AKSESUARLARI | | | | |
| ⚡ CE IP40 | | | | |
| 001 039 060025 00 00 | 60x25 MM İÇ KÖŞE | 48 | ad. | 41,50 |
| 001 040 060025 00 00 | 60x25 MM DIŞ KÖŞE | 72 | ad. | 41,50 |
| 001 041 060025 00 00 | 60x25 MM T KÖŞE | 40 | ad. | 51,90 |
| 001 042 060025 00 00 | 60x25 MM 90 L KÖŞE | 60 | ad. | 51,90 |
| 001 044 060025 00 00 | 60x25 MM UÇ TAPA | 50 | ad. | 30,70 |
| 001 043 060025 00 00 | 60x25 MM EK PARÇASI | 60 | ad. | 30,70 |
| 60X40 KANAL AKSESUARLARI | | | | |
| ⚡ CE IP40 | | | | |
| 001 039 060040 00 00 | 60x40 MM İÇ KÖŞE | 26 | ad. | 52,20 |
| 001 040 060040 00 00 | 60x40 MM DIŞ KÖŞE | 32 | ad. | 52,20 |
| 001 041 060040 00 00 | 60x40 MM T KÖŞE | 32 | ad. | 54,80 |
| 001 042 060040 00 00 | 60x40 MM 90 L KÖŞE | 40 | ad. | 54,80 |
| 001 044 060040 00 00 | 60x40 MM UÇ TAPA | 50 | ad. | 31,10 |
| 001 043 060040 00 00 | 60x40 MM EK PARÇASI | 40 | ad. | 31,10 |
| 60X60 KANAL AKSESUARLARI | | | | |
| ⚡ CE IP40 | | | | |
| 001 039 060060 01 00 | 60x60 MM İÇ KÖŞE (HAREKETLİ) | 16 | ad. | 70,40 |
| 001 040 060060 01 00 | 60x60 MM DIŞ KÖŞE (HAREKETLİ) | 16 | ad. | 70,40 |
| 001 041 060060 00 00 | 60x60 MM T KÖŞE | 20 | ad. | 88,90 |
| 001 042 060060 00 00 | 60x60 MM 90 L KÖŞE | 24 | ad. | 88,90 |
| 001 044 060060 00 00 | 60x60 MM UÇ TAPA | 30 | ad. | 48,10 |
| 001 043 060060 00 00 | 60x60 MM EK PARÇASI | 25 | ad. | 48,10 |
| 80X40 KANAL AKSESUARLARI | | | | |
| ⚡ CE IP40 | | | | |
| 001 039 080040 00 00 | 80x40 MM İÇ KÖŞE | 18 | ad. | 81,50 |
| 001 040 080040 00 00 | 80x40 MM DIŞ KÖŞE | 8 | ad. | 81,50 |
| 001 041 080040 00 00 | 80x40 MM T KÖŞE | 12 | ad. | 92,60 |
| 001 042 080040 00 00 | 80x40 MM 90 L KÖŞE | 16 | ad. | 92,60 |
| 001 044 080040 00 00 | 80x40 MM UÇ TAPA | 60 | ad. | 63,00 |
| 001 043 080040 00 00 | 80x40 MM EK PARÇASI | 100 | ad. | 63,00 |
| 80X60 KANAL AKSESUARLARI | | | | |
| ⚡ CE IP40 | | | | |
| 001 039 080060 00 00 | 80x60 MM İÇ KÖŞE | 12 | ad. | 85,20 |
| 001 040 080060 00 00 | 80x60 MM DIŞ KÖŞE | 8 | ad. | 85,20 |
| 001 041 080060 00 00 | 80x60 MM T KÖŞE | 10 | ad. | 96,30 |
| 001 042 080060 00 00 | 80x60 MM 90 L KÖŞE | 12 | ad. | 96,30 |
| 001 044 080060 00 00 | 80x60 MM UÇ TAPA | 48 | ad. | 66,70 |
| 001 043 080060 00 00 | 80x60 MM EK PARÇASI | 80 | ad. | 66,70 |
| 100X37 KANAL AKSESUARLARI | | | | |
| ⚡ CE IP40 | | | | |
| 001 039 100037 00 00 | 100x37 MM İÇ KÖŞE (SABİT) | 12 | ad. | 70,40 |
| 001 040 100037 00 00 | 100x37 MM DIŞ KÖŞE (SABİT) | 8 | ad. | 70,40 |
| 001 039 100037 01 00 | 100x37 MM İÇ KÖŞE (HAREKETLİ) | 12 | ad. | 70,40 |
| 001 040 100037 01 00 | 100x37 MM DIŞ KÖŞE (HAREKETLİ) | 10 | ad. | 70,40 |
| 001 041 100037 00 00 | 100x37 MM T PARÇASI | 14 | ad. | 74,10 |
| 001 042 100037 00 00 | 100x37 MM 90 L KÖŞE | 14 | ad. | 74,10 |
| 001 044 100037 00 00 | 100x37 MM UÇ TAPA | 50 | ad. | 37,00 |
| 001 043 100037 00 00 | 100x37 MM EK PARÇA | 100 | ad. | 37,00 |
| 001 050 030003 00 00 | 100x37/41/50 MM KANAL KİLİTLEME APARATI | 75 | ad. | 13,90 |
| 100X40 KANAL AKSESUARLARI | | | | |
| ⚡ CE IP40 | | | | |
| 001 039 100040 00 00 | 100x40 MM İÇ KÖŞE (SABİT) | 8 | ad. | 81,50 |
| 001 040 100040 00 00 | 100x40 MM DIŞ KÖŞE (SABİT) | 8 | ad. | 81,50 |
| 001 039 100040 01 00 | 100x40 MM İÇ KÖŞE (HAREKETLİ) | 16 | ad. | 81,50 |
| 001 040 100040 01 00 | 100x40 MM DIŞ KÖŞE (HAREKETLİ) | 10 | ad. | 81,50 |
| 001 041 100040 00 00 | 100x40 MM T PARÇASI | 12 | ad. | 100,00 |
| 001 042 100040 00 00 | 100x40 MM 90 L KÖŞE | 12 | ad. | 100,00 |
| 001 044 100060 00 00 | 100x40 MM UÇ TAPA | 20 | ad. | 38,10 |
| 001 043 100060 00 00 | 100x40 MM EK PARÇA | 100 | ad. | 38,10 |
| 001 050 030004 00 00 | 100x40 MM KANAL KİLİTLEME APARATI | 100 | ad. | 13,90 |
| 001 013 100040 20 00 | 100x40 MM ARA BÖLME | 200 | mt. | 55,60 |



UÇ TAPA



T KÖŞE

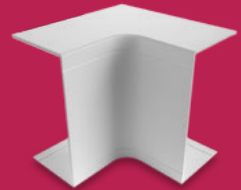

İÇ KÖŞE



EK PARÇA

PRİZ MONTAJ KASASI

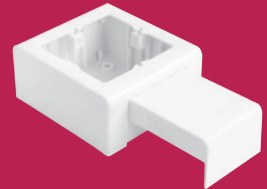

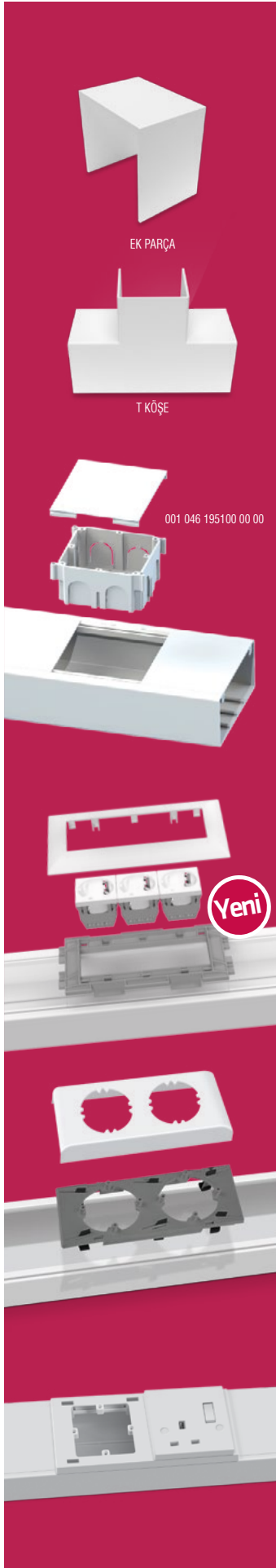

| Ürün Kodu | Ürün Adı | Amb. (Kutu) | Amb. Birimi | Fiyat (₺) |
|--|--|-------------|-------------|-----------|
| 100X48 KANAL AKSESUARLARI | | | | |
| TS CE IP40 | | | | |
| 001 039 100048 00 00 | 100X48 MM İÇ KÖŞE (SABİT) | 8 | ad. | 85,20 |
| 001 040 100048 00 00 | 100X48 MM DIŞ KÖŞE (SABİT) | 8 | ad. | 85,20 |
| 001 039 100048 01 00 | 100X48 MM İÇ KÖŞE (HAREKETLİ) | 10 | ad. | 85,20 |
| 001 040 100048 01 00 | 100X48 MM DIŞ KÖŞE (HAREKETLİ) | 10 | ad. | 85,20 |
| 001 041 100048 00 00 | 100X48 MM T PARÇASI | 8 | ad. | 103,90 |
| 001 042 100048 00 00 | 100X48 MM 90 L KÖŞE | 8 | ad. | 103,90 |
| 001 044 100060 00 00 | 100X48 MM UÇ TAPA | 20 | ad. | 40,70 |
| 001 043 100060 00 00 | 100X48 MM EK PARÇA | 100 | ad. | 40,70 |
| 001 050 030004 00 00 | 100X48 MM KANAL KİLİTLEME APARATI | 100 | ad. | 13,90 |
| 001 013 100048 20 00 | 100X48 MM ARA BÖLME | 150 | mt. | 44,40 |
| 100X50/41 KANAL AKSESUARLARI | | | | |
| TS CE IP40 | | | | |
| 001 039 100050 00 00 | 100X50/41 MM İÇ KÖŞE (SABİT) | 8 | ad. | 53,70 |
| 001 040 100050 00 00 | 100X50/41 MM DIŞ KÖŞE (SABİT) | 8 | ad. | 53,70 |
| 001 039 100050 01 00 | 100X50/41 MM İÇ KÖŞE (HAREKETLİ) | 10 | ad. | 53,70 |
| 001 040 100050 01 00 | 100X50/41 MM DIŞ KÖŞE (HAREKETLİ) | 8 | ad. | 53,70 |
| 001 041 100050 00 00 | 100X50/41 MM T PARÇASI | 10 | ad. | 66,70 |
| 001 042 100050 00 00 | 100X50/41 MM 90 L KÖŞE | 10 | ad. | 66,70 |
| 001 044 100050 00 00 | 100X50/41 MM UÇ TAPA | 40 | ad. | 38,90 |
| 001 043 100050 00 00 | 100X50/41 MM EK PARÇA | 100 | ad. | 38,90 |
| 001 043 100050 01 00 | 100X50 MM EK PARÇA (3LÜ SET) | 100 | ad. | 38,90 |
| 001 046 195100 00 00 | 100X50 MM KANAL İÇİ KÜP BUAT | 25 | ad. | 55,60 |
| 001 013 100048 20 00 | 100X48 - 100X50 MM ARA BÖLME | 150 | mt. | 44,40 |
| 001 050 030003 00 00 | 100X37/41/50 MM KANAL KİLİTLEME APARATI | 75 | ad. | 13,90 |
| 100X50 KAİDESİZ KANAL AKSESUARLARI | | | | |
| TS CE IP40 | | | | |
| 001 039 100051 00 00 | 100X50 MM KAİDESİZ İÇ KÖŞE | 8 | ad. | 61,10 |
| 001 040 100051 00 00 | 100X50 MM KAİDESİZ DIŞ KÖŞE | 8 | ad. | 61,10 |
| 001 041 100051 00 00 | 100X50 MM KAİDESİZ T PARÇASI | 10 | ad. | 85,20 |
| 001 042 100051 00 00 | 100X50 MM KAİDESİZ 90 L KÖŞE | 10 | ad. | 85,20 |
| 001 043 100051 00 00 | 100X50 MM KAİDESİZ EK PARÇA | 100 | ad. | 51,90 |
| 001 044 100051 00 00 | 100X50 MM KAİDESİZ UÇ TAPA | 40 | ad. | 51,90 |
| 001 888 100050 00 00 | 100X50 MM KABLO KANALI MONTAJ APARATI | 50 | ad. | 55,60 |
| 100X60 KANAL AKSESUARLARI | | | | |
| TS CE IP40 | | | | |
| 001 039 100060 00 00 | 100X60 MM İÇ KÖŞE (SABİT) | 8 | ad. | 88,90 |
| 001 040 100060 00 00 | 100X60 MM DIŞ KÖŞE (SABİT) | 8 | ad. | 88,90 |
| 001 039 100060 01 00 | 100X60 MM İÇ KÖŞE (HAREKETLİ) | 8 | ad. | 88,90 |
| 001 040 100060 01 00 | 100X60 MM DIŞ KÖŞE (HAREKETLİ) | 10 | ad. | 88,90 |
| 001 041 100060 00 00 | 100X60 MM T PARÇASI | 8 | ad. | 100,00 |
| 001 042 100060 00 00 | 100X60 MM 90 L KÖŞE | 8 | ad. | 100,00 |
| 001 044 100060 00 00 | 100X60 MM UÇ TAPA | 16 | ad. | 27,80 |
| 001 043 100060 00 00 | 100X60 MM EK PARÇA | 100 | ad. | 27,80 |
| 001 050 030004 00 00 | 100X60 MM KANAL KİLİTLEME APARATI | 100 | ad. | 13,90 |
| 001 013 100060 20 00 | 100X60 MM ARA BÖLME | 130 | ad. | 63,00 |
| 120X60 KANAL AKSESUARLARI | | | | |
| TS CE IP40 | | | | |
| 001 039 120060 00 00 | 120X60 MM İÇ KÖŞE | 8 | ad. | 107,40 |
| 001 040 120060 00 00 | 120X60 MM DIŞ KÖŞE | 8 | ad. | 107,40 |
| 001 041 120060 00 00 | 120X60 MM T PARÇA | 8 | ad. | 114,80 |
| 001 042 120060 00 00 | 120X60 MM 90 L KÖŞE | 8 | ad. | 114,80 |
| 001 044 120060 00 00 | 120X60 MM UÇ TAPA | 20 | ad. | 35,20 |
| 001 043 120060 00 00 | 120X60 MM EK PARÇA | 50 | ad. | 35,20 |
| 170X50 KANAL AKSESUARLARI | | | | |
| TS CE IP40 | | | | |
| 001 039 170050 00 00 | 170X50 MM İÇ KÖŞE | 32 | ad. | 129,60 |
| 001 040 170050 00 00 | 170X50 MM DIŞ KÖŞE | 44 | ad. | 129,60 |
| 001 041 170050 00 00 | 170X50 MM T PARÇA | 16 | ad. | 155,60 |
| 001 042 170050 00 00 | 170X50 MM 90 L KÖŞE | 16 | ad. | 155,60 |
| 001 044 170050 00 00 | 170X50 MM UÇ TAPA | 125 | ad. | 42,60 |
| 001 043 170050 00 00 | 170X50 MM EK PARÇA | 125 | ad. | 42,60 |
| İÇTEN KAPAKLI 100X37/50 İÇİN PRİZ MONTAJ SETİ (45x45) | | | | |
| TS CE IP40 | | | | |
| 001 047 070001 00 00 | 100X37/50 İÇİN 45X45 PMS (TEKLİ) | 30 | ad. | 40,70 |
| 001 047 070002 00 00 | 100X37/50 İÇİN 45X45 PMS (İKİLİ) | 16 | ad. | 54,80 |
| 001 047 070003 00 00 | 100X37/50 İÇİN 45X45 PMS (ÜÇLÜ) | 14 | ad. | 62,00 |
| 001 047 070004 00 00 | 100X37/50 İÇİN 45X45 PMS (DÖRTLÜ) | 13 | ad. | 112,90 |
| İÇTEN KAPAKLI 100X37/50 İÇİN PRİZ MONTAJ SETİ (55X55) | | | | |
| 001 047 080001 00 00 | 100X37/50 İÇİN 55X55 PMS (TEKLİ) | 20 | ad. | 67,70 |
| 001 047 080002 00 00 | 100X37/50 İÇİN 55X55 PMS (İKİLİ) | 14 | ad. | 112,30 |
| 001 047 080003 00 00 | 100X37/50 İÇİN 55X55 PMS (ÜÇLÜ) | 12 | ad. | 133,50 |
| DİŞTAN KAPAKLI 100'LÜK KANAL PRİZ MONTAJ SETİ (55X55) | | | | |
| 001 047 020001 00 00 | 100'LÜK 55X55 PMS TEKLİ | 20 | ad. | 109,60 |
| 001 047 020002 00 00 | 100'LÜK 55X55 PMS İKİLİ | 14 | ad. | 137,20 |
| 001 047 020003 00 00 | 100'LÜK 55X55 PMS ÜÇLÜ | 12 | ad. | 168,90 |
| DİŞTAN KAPAKLI 100'LÜK KANAL PRİZ MONTAJ SETİ (45x45) | | | | |
| TS CE IP40 | | | | |
| 001 047 040001 00 00 | 100'LÜK 45X45 PMS TEKLİ | 20 | ad. | 88,30 |
| 001 047 040002 00 00 | 100'LÜK 45X45 PMS İKİLİ | 14 | ad. | 127,90 |
| 001 047 040003 00 00 | 100'LÜK 45X45 PMS ÜÇLÜ | 12 | ad. | 178,60 |
| 001 047 040004 00 00 | 100'LÜK 45X45 PMS DÖRTLÜ | 10 | ad. | 180,50 |
| İNGİLİZ NORMU PRİZ MONTAJ SETLERİ (100x50/37) | | | | |
| 001 047 980001 00 00 | İNGİLİZ NORMU TEKLİ PRİZ TABANI | 200 | ad. | 45,00 |
| 001 047 980002 00 00 | İNGİLİZ NORMU İKİLİ PRİZ TABANI | 100 | ad. | 47,40 |
| 001 047 990002 00 00 | İNGİLİZ NORMU İKİLİ YÜKSEK TİP PRİZ TABANI | 94 | ad. | 92,60 |
| 001 166 000001 00 00 | SIVA ALTI ANAHTAR KASASI | 28 | ad. | 46,30 |



KANAL İÇİN UPS VE ENERJİ PRİZLERİ (45x45)



| | |
|---------------|---|
| ÜRÜN KODU | 001 052 300001 00 00 |
| ÜRÜN ADI | 45x45 TOP.P. ÇEKİRDEĞİ Ç.K. (45°) |
| AMB. AD./KOLİ | 50/300 |
| FİYAT (₺) | 92,60 |



| | |
|---------------|---|
| ÜRÜN KODU | 001 052 300002 00 00 |
| ÜRÜN ADI | 45x45 UPS.P. ÇEKİRDEĞİ Ç.K. (45°) |
| AMB. AD./KOLİ | 50/300 |
| FİYAT (₺) | 94,40 |

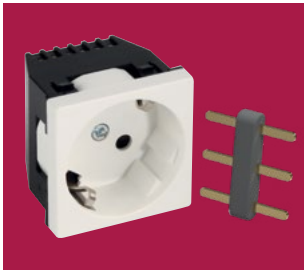

| | |
|---------------|--|
| ÜRÜN KODU | 001 052 200003 00 00 |
| ÜRÜN ADI | 45x45 PRİZ BİRLEŞTİRME APARATI (YANDAN) (YENİ) |
| AMB. AD./KOLİ | 500/5000 |
| FİYAT (₺) | 34,10 |

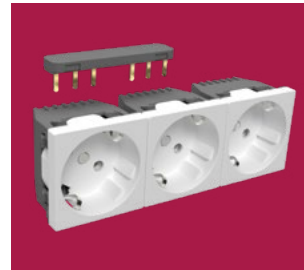

| | |
|---------------|-----------------------------------|
| ÜRÜN KODU | 001 052 200005 00 00 |
| ÜRÜN ADI | 45x45 PRİZ BİRLEŞTİRME APARATI |
| AMB. AD./KOLİ | 50/500 |
| FİYAT (₺) | 55,60 |



| | |
|---------------|-----------------|
| ÜRÜN KODU | 888 049 050040 |
| ÜRÜN ADI | 45x22,5 ANAHTAR |
| AMB. AD./KOLİ | 20/400 |
| FİYAT | 3,36 \$ |



| | |
|---------------|----------------|
| ÜRÜN KODU | 888 049 050043 |
| ÜRÜN ADI | 45x22,5 VAVİEN |
| AMB. AD./KOLİ | 20/400 |
| FİYAT | 3,90 \$ |

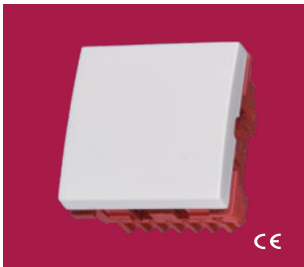

| | |
|---------------|----------------|
| ÜRÜN KODU | 888 049 050063 |
| ÜRÜN ADI | 45x45 ANAHTAR |
| AMB. AD./KOLİ | 10/200 |
| FİYAT | 4,81 \$ |

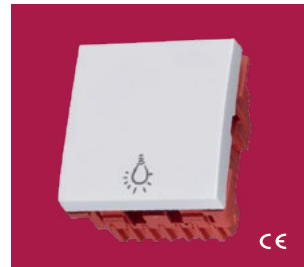

| | |
|---------------|--------------------------------|
| ÜRÜN KODU | 888 049 050044 |
| ÜRÜN ADI | 45x45 YAYLI ÇAĞIRMA (LIGHT) |
| AMB. AD./KOLİ | 10/200 |
| FİYAT | 4,81 \$ |

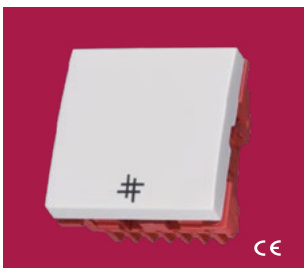

| | |
|---------------|------------------|
| ÜRÜN KODU | 888 049 050064 |
| ÜRÜN ADI | 45x45 ARA VAVİEN |
| AMB. AD./KOLİ | 10/200 |
| FİYAT | 6,60 \$ |

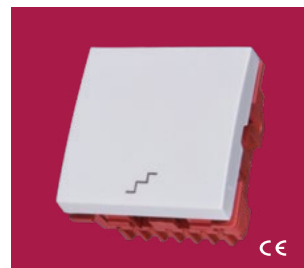

| | |
|---------------|----------------|
| ÜRÜN KODU | 888 049 050065 |
| ÜRÜN ADI | 45x45 VAVİEN |
| AMB. AD./KOLİ | 10/200 |
| FİYAT | 5,10 \$ |



KANAL İÇİN UPS VE ENERJİ PRİZLERİ (45x45)

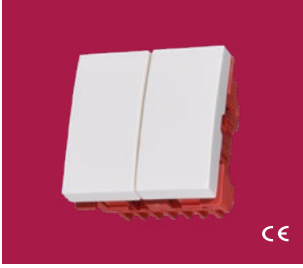

| | |
|---------------|-----------------|
| ÜRÜN KODU | 888 049 050042 |
| ÜRÜN ADI | 45x45 KOMİTATÖR |
| AMB. AD./KOLİ | 10/200 |
| FİYAT | 5,90 \$ |



| | |
|---------------|-----------------------|
| ÜRÜN KODU | 888 049 050041 |
| ÜRÜN ADI | 45x45 ÇOK AMAÇLI PRİZ |
| AMB. AD./KOLİ | 10/200 |
| FİYAT | 5,90 \$ |

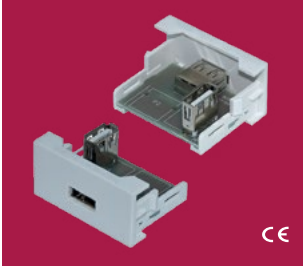

| | |
|---------------|---------------------------------------|
| ÜRÜN KODU | 888 049 050058 |
| ÜRÜN ADI | 45x22,5 USB 2.0 - AF/AF DATA 90 GİRİŞ |
| AMB. AD./KOLİ | 50/500 |
| FİYAT | 3,08 \$ |



| | |
|---------------|--|
| ÜRÜN KODU | 888 049 050059 |
| ÜRÜN ADI | 45x22,5 USB 2.0 - AF/AF DATA 180 GİRİŞ |
| AMB. AD./KOLİ | 50/500 |
| FİYAT | 3,08 \$ |

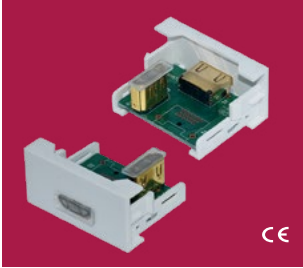

| | |
|---------------|-----------------------|
| ÜRÜN KODU | 888 049 050046 |
| ÜRÜN ADI | 45x22,5 HDMI 90 GİRİŞ |
| AMB. AD./KOLİ | 50/500 |
| FİYAT | 8,76 \$ |



| | |
|---------------|-----------------------|
| ÜRÜN KODU | 888 049 050047 |
| ÜRÜN ADI | 45x22,5 VGA DATA JACK |
| AMB. AD./KOLİ | 50/500 |
| FİYAT | 4,98 \$ |



| | |
|---------------|------------------------|
| ÜRÜN KODU | 888 049 050056 |
| ÜRÜN ADI | 45x22,5 TV PRİZİ ERKEK |
| AMB. AD./KOLİ | 50/500 |
| FİYAT | 2,23 \$ |



| | |
|---------------|-----------------------|
| ÜRÜN KODU | 888 049 050057 |
| ÜRÜN ADI | 45x22,5 TV PRİZİ DIŞI |
| AMB. AD./KOLİ | 50/500 |
| FİYAT | 2,33 \$ |



| | |
|---------------|----------------|
| ÜRÜN KODU | 888 049 050049 |
| ÜRÜN ADI | 45x22,5 RCA |
| AMB. AD./KOLİ | 50/500 |
| FİYAT | 5,49 \$ |

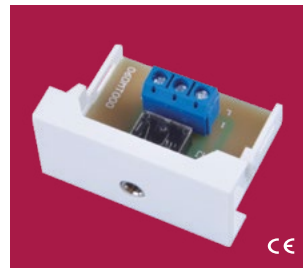

| | |
|---------------|--------------------------------|
| ÜRÜN KODU | 888 049 050060 |
| ÜRÜN ADI | 45x22,5 SES JAKI 3,5 mm STEREO |
| AMB. AD./KOLİ | 50/500 |
| FİYAT | 3,02 \$ |



KANAL İÇİN UPS VE ENERJİ PRİZLERİ (45x45)



| | |
|---------------|-------------------|
| ÜRÜN KODU | 888 049 050051 |
| ÜRÜN ADI | 45x22,5 KÖR KAPAK |
| AMB. AD./KOLİ | 100/1000 |
| FİYAT | 0,35 \$ |



| | |
|---------------|--------------------------------------|
| ÜRÜN KODU | 888 049 050012 |
| ÜRÜN ADI | 45x22,5 KEYSTONE JACK PANJURLU KAPAK |
| AMB. AD./KOLİ | 100/1000 |
| FİYAT | 0,47 \$ |

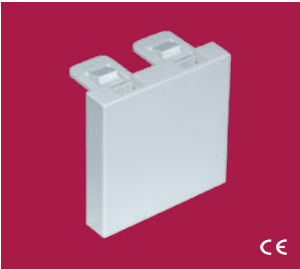

| | |
|---------------|-----------------|
| ÜRÜN KODU | 888 049 050055 |
| ÜRÜN ADI | 45x45 KÖR KAPAK |
| AMB. AD./KOLİ | 100/400 |
| FİYAT | 0,36 \$ |



| | |
|---------------|------------------------------------|
| ÜRÜN KODU | 888 049 050013 |
| ÜRÜN ADI | 45x45 KEYSTONE JACK PANJURLU KAPAK |
| AMB. AD./KOLİ | 100/500 |
| FİYAT | 0,65 \$ |



| | |
|---------------|--------------------------------|
| ÜRÜN KODU | 888 049 050061 |
| ÜRÜN ADI | 45x22,5 USB ŞARJ PRİZİ 5V 2,1A |
| AMB. AD./KOLİ | 10/200 |
| FİYAT | 22,04 \$ |



| | |
|---------------|--------------------------------------|
| ÜRÜN KODU | 888 049 050062 |
| ÜRÜN ADI | 45x22,5 U2'Lİ USB ŞARJ PRİZİ 5V 2,1A |
| AMB. AD./KOLİ | 20/200 |
| FİYAT | 24,89 \$ |



| | |
|---------------|---|
| ÜRÜN KODU | 888 049 050074 |
| ÜRÜN ADI | 45x45 ŞARJ PRİZİ TYPE-C+ TYPE-C (C+C) 5V 4.2A |
| AMB. AD./KOLİ | 10/200 |
| FİYAT | 28,30 \$ |



| | |
|---------------|-----------------------------------|
| ÜRÜN KODU | 888 049 050075 |
| ÜRÜN ADI | 45x45 ŞARJ PRİZİ TYPE-C (C) 5V 3A |
| AMB. AD./KOLİ | 10/200 |
| FİYAT | 21,43 \$ |



| | |
|---------------|---|
| ÜRÜN KODU | 888 049 050076 |
| ÜRÜN ADI | 45x45 ŞARJ PRİZİ USB+TYPE-C (A+C) 5V 4.2A |
| AMB. AD./KOLİ | 10/200 |
| FİYAT | 27,54 \$ |

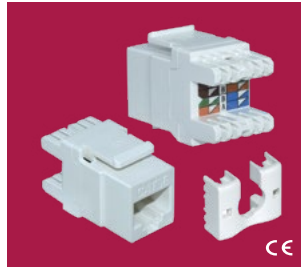

| | |
|---------------|-------------------------------|
| ÜRÜN KODU | 888 049 050008 |
| ÜRÜN ADI | DATA KONNEKTÖRÜ CAT 5e (RJ45) |
| AMB. AD./KOLİ | 100/1000 |
| FİYAT | 1,23 \$ |



| | |
|---------------|---------------------------------|
| ÜRÜN KODU | 888 049 050032 |
| ÜRÜN ADI | DATA KONNEKTÖRÜ CAT 6e (RJ65 8) |
| AMB. AD./KOLİ | 100/1000 |
| FİYAT | 1,25 \$ |

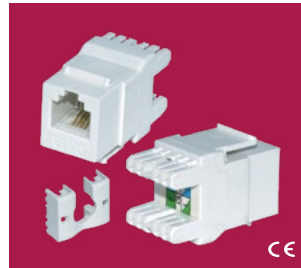

| | |
|---------------|---------------------------------|
| ÜRÜN KODU | 888 049 050009 |
| ÜRÜN ADI | TELEFON KONNEKTÖRÜ (RJ 11/12 6) |
| AMB. AD./KOLİ | 100/1000 |
| FİYAT | 1,23 \$ |

RACK KABİN PRİZ ve AKSESUARLARI



| | |
|---------------|--|
| ÜRÜN KODU | 075 171 222508 |
| ÜRÜN ADI | 16 MODÜL DÖŞEME ALTI PRİZ SİSTEMİ(BOŞ) 270x270 |
| AMB. AD./KOLİ | 1/10 |
| FİYAT (₺) | 1.967,78 |



| | |
|---------------|---|
| ÜRÜN KODU | 075 171 333308 |
| ÜRÜN ADI | 16 MODÜL DÖŞEME ALTI PRİZ SİSTEMİ BUATI 352x352 |
| AMB. AD./KOLİ | 1/5 |
| FİYAT (₺) | 2.004,81 |

KABLO TOPLAMA SİRALI (GRİ - SİYAH)



| Ürün Kodu | Ürün Adı | Amb. Birimi | Koli Adedi | Ad. /Mt. Fiyat |
|----------------|--|-------------|------------|----------------|
| 888 020 9XX003 | R1034 16 mm KABLO TOP. SPR. (1,5m VAK) | 1 ad. | 120 | 5,51 \$ |
| 888 020 9XX006 | R1035 22 mm KABLO TOP. SPR. (1,5m VAK) | 1 ad. | 80 | 7,49 \$ |
| 888 020 9XX009 | R1036 28 mm KABLO TOP. SPR. (1,5m VAK) | 1 ad. | 70 | 9,53 \$ |
| 888 020 9XX001 | R1033 10 mm KABLO TOP. SPR. (50 mt.RULO) | 50 mt. | 300 | 2,73 \$ |
| 888 020 9XX004 | R1034 16 mm KABLO TOP. SPR. (25 mt.RULO) | 25 mt. | 200 | 3,05 \$ |
| 888 020 9XX007 | R1035 22 mm KABLO TOP. SPR. (20 mt.RULO) | 20 mt. | 160 | 4,26 \$ |
| 888 020 9XX010 | R1036 28 mm KABLO TOP. SPR. (15 mt.RULO) | 15 mt. | 120 | 5,56 \$ |
| 888 020 9XX011 | R1037 34 mm KABLO TOP. SPR. (25 mt.RULO) | 25 mt. | 50 | 6,95 \$ |

XX: Gri: 00 Siyah: 11



KABLO OMURGA KANALI

| Ürün Kodu | Ürün Adı | Amb. Birimi | Koli Adedi | Fiyat (₺) |
|----------------|-----------------------------|-------------|------------|-----------|
| 888 020 200801 | KABLO OMURGA KANALI - BEYAZ | 1 ad. | 30 | 655,93 |
| 888 020 200802 | KABLO OMURGA KANALI - GRİ | 1 ad. | 30 | 632,50 |
| 888 020 200803 | KABLO OMURGA KANALI - SİYAH | 1 ad. | 30 | 632,50 |

| Ürün Kodu | Ürün Adı | Amb. (Kutu) | Amb. Birimi | Fiyat (₺) |
|---|--|-------------|-------------|-----------|
| SİDEM SERİSİ RENKLİ KABLO KANALLARI | | | | |
| 001 007 010008 20 XX | 10X8 MM KABLO KANALI (SİDEM) | 330 | mt. | 59,35 |
| 001 007 012012 20 XX | 12X12 MM KABLO KANALI (SİDEM) | 250 | mt. | 61,00 |
| 001 007 015010 20 XX | 15X10 MM KABLO KANALI (SİDEM) | 250 | mt. | 56,00 |
| 001 007 016016 20 XX | 16X16 MM KABLO KANALI (SİDEM) | 250 | mt. | 76,00 |
| 001 007 020010 20 XX | 20X10 MM KABLO KANALI (SİDEM) | 200 | mt. | 61,00 |
| 001 007 025016 20 XX | 25X16 MM KABLO KANALI (SİDEM) | 150 | mt. | 94,00 |
| 001 007 025025 20 XX | 25X25 MM KABLO KANALI (SİDEM) | 100 | mt. | 122,00 |
| 001 007 930010 20 XX | 30X10 MM KABLO KANALI (SİDEM) BÖLMELİ | 140 | mt. | 103,95 |
| 001 007 930016 20 XX | 30X16 MM KABLO KANALI (SİDEM) BÖLMELİ | 140 | mt. | 137,53 |
| 001 007 030025 20 XX | 30X25 MM KABLO KANALI (SİDEM) | 80 | mt. | 160,00 |
| 001 007 040016 20 XX | 40X16 MM KABLO KANALI (SİDEM) | 100 | mt. | 127,00 |
| 001 007 940016 20 XX | 40X16 MM KABLO KANALI (SİDEM)(BÖLMELİ) | 100 | mt. | 148,41 |
| 001 007 040025 20 XX | 40X25 MM KABLO KANALI (SİDEM) | 80 | mt. | 161,00 |
| 001 007 040040 20 XX | 40X40 MM KABLO KANALI (SİDEM) | 50 | mt. | 181,00 |
| 001 007 960025 20 XX | 60X25 MM KABLO KANALI (SİDEM) BÖLMELİ | 40 | mt. | 272,00 |
| 001 007 060040 20 XX | 60X40 MM KABLO KANALI (SİDEM) | 40 | mt. | 235,00 |
| 001 007 060060 20 XX | 60X60 MM KABLO KANALI (SİDEM) | 32 | mt. | 372,00 |
| 001 007 080040 20 XX | 80X40 MM KABLO KANALI (SİDEM) | 30 | mt. | 369,00 |
| 001 007 080060 20 XX | 80X60 MM KABLO KANALI (SİDEM) | 24 | mt. | 408,00 |
| 001 007 100040 20 XX | 100X40 MM KABLO KANALI (SİDEM) | 24 | mt. | 454,00 |
| 001 007 100048 20 XX | 100X48 MM KABLO KANALI (SİDEM) | 24 | mt. | 435,00 |
| 001 007 100060 20 XX | 100X60 MM KABLO KANALI (SİDEM) | 20 | mt. | 622,00 |
| 001 007 075060 20 XX | 75X60 MM KABLO KANALI (SİDEM) | 30 | mt. | 419,00 |
| 001 007 100037 20 XX | 100X37 MM KABLO KANALI (SİDEM) İ.KAPAKLI | 30 | mt. | 491,00 |
| 001 007 100050 20 XX | 100X50 MM KABLO KANALI (SİDEM) İ.KAPAKLI | 20 | mt. | 501,00 |
| 001 007 120060 20 XX | 120X60 MM KABLO KANALI (SİDEM) İ.KAPAKLI | 16 | mt. | 706,00 |
| 001 007 120070 20 XX | 120X70 MM KABLO KANALI (SİDEM) | 16 | mt. | 951,00 |
| 001 007 170070 20 XX | 170X70 MM KABLO KANALI (SİDEM) | 12 | mt. | 1.076,08 |
| SİDEM SERİSİ RENKLİ KABLO KANALLARI (YAPIŞKANLI) | | | | |
| 001 155 010008 20 XX | 10X8 MM KABLO KANALI (SİDEM) YAPIŞKANLI | 330 | mt. | 69,85 |
| 001 155 012012 20 XX | 12X12 MM KABLO KANALI (SİDEM) YAPIŞKANLI | 250 | mt. | 65,00 |
| 001 155 015010 20 XX | 15X10 MM KABLO KANALI (SİDEM) YAPIŞKANLI | 250 | mt. | 67,00 |
| 001 155 016016 20 XX | 16X16 MM KABLO KANALI (SİDEM) YAPIŞKANLI | 240 | mt. | 79,00 |
| 001 155 020010 20 XX | 20X10 MM KABLO KANALI (SİDEM) YAPIŞKANLI | 180 | mt. | 67,00 |
| 001 155 025016 20 XX | 25X16 MM KABLO KANALI (SİDEM) YAPIŞKANLI | 150 | mt. | 98,00 |
| 001 155 025025 20 XX | 25X25 MM KABLO KANALI (SİDEM) YAPIŞKANLI | 100 | mt. | 130,00 |
| 001 155 930010 20 XX | 30X10 MM KABLO KANALI (SİDEM) YAPIŞKANLI | 140 | mt. | 93,13 |
| 001 155 930016 20 XX | 30X16 MM KABLO KANALI (SİDEM) YAPIŞKANLI | 140 | mt. | 115,00 |
| 001 155 030025 20 XX | 30X25 MM KABLO KANALI (SİDEM) YAPIŞKANLI | 80 | mt. | 163,00 |
| 001 155 040016 20 XX | 40X16 MM KABLO KANALI (SİDEM) YAPIŞKANLI | 100 | mt. | 202,00 |
| 001 155 040025 20 XX | 40X25 MM KABLO KANALI (SİDEM) YAPIŞKANLI | 80 | mt. | 180,00 |
| 001 155 040040 20 XX | 40X40 MM KABLO KANALI (SİDEM) YAPIŞKANLI | 50 | mt. | 199,00 |
| 001 155 960025 20 XX | 60X25 MM KABLO KANALI (SİDEM) YAPIŞKANLI | 40 | mt. | 278,07 |
| 001 155 060040 20 XX | 60X40 MM KABLO KANALI (SİDEM) YAPIŞKANLI | 40 | mt. | 276,00 |
| SİDEM SERİSİ SÜPÜRGELİKLER ve AKSESUARLARI | | | | |
| 001 007 974020 20 XX | 74X20 MM KABLO KANALI (SİDEM) BÖLMELİ | 50 | mt. | 211,00 |
| 001 007 975022 20 XX | 75X22 MM KABLO KANALI (SİDEM) BÖLMELİ | 50 | mt. | 324,00 |
| SİDEM SERİSİ BALIK SIRTI ZEMİN KANALLARI ve AKSESUARLARI | | | | |
| 001 007 050013 20 XX | 50X13 MM KABLO KANALI (SİDEM) | 60 | mt. | 176,96 |
| 001 007 060015 20 XX | 60X15 MM KABLO KANALI (SİDEM) | 40 | mt. | 196,00 |
| 001 031 060015 00 XX | 60X15 MM L KÖŞE(SİDEM) | 1 | ad. | 88,00 |
| 001 032 060015 00 XX | 60X15 MM EK PARÇA (SİDEM) | 1 | ad. | 54,00 |
| 001 033 060015 00 XX | 60X15 MM SONLAMA KAPAĞI (SİDEM) | 1 | ad. | 31,00 |
| 001 030 060015 00 XX | 60X15 MM T KÖŞE (SİDEM) | 1 | ad. | 100,20 |
| 001 007 075018 20 XX | 75X18 MM KABLO KANALI (SİDEM) | 30 | mt. | 283,00 |
| 001 007 090020 20 XX | 90X20 MM KABLO KANALI (SİDEM) | 20 | mt. | 424,00 |
| SİDEM SERİSİ BALIK SIRTI ZEMİN KANALLARI (YAPIŞKANLI) | | | | |
| 001 155 050013 20 XX | 50X13 MM KABLO KANALI (SİDEM) YAPIŞKANLI | 60 | mt. | 278,00 |
| 001 155 060015 20 XX | 60X15 MM KABLO KANALI (SİDEM) YAPIŞKANLI | 40 | mt. | 300,00 |
| 001 155 075018 20 XX | 75X18 MM KABLO KANALI (SİDEM) YAPIŞKANLI | 30 | mt. | 325,00 |
| 12x12 KANAL AKSESUARLARI - SİDEM SERİSİ | | | | |
| 001 028 012012 00 XX | 12X12 MM (SİDEM) İÇ KÖŞE | 1 | ad. | 45,40 |
| 001 029 012012 00 XX | 12X12 MM (SİDEM) DIŞ KÖŞE | 1 | ad. | 45,40 |
| 001 030 012012 00 XX | 12X12 MM (SİDEM) T KÖŞE | 1 | ad. | 44,80 |
| 001 031 012012 00 XX | 12X12 MM (SİDEM) 90 L KÖŞE | 1 | ad. | 44,80 |
| 001 033 012012 00 XX | 12X12 MM (SİDEM) UÇ TAPA | 1 | ad. | 30,40 |
| 001 032 012012 00 XX | 12X12 MM (SİDEM) EK PARÇASI | 1 | ad. | 30,40 |
| 15x10 KANAL AKSESUARLARI - SİDEM SERİSİ | | | | |
| 001 028 015010 00 XX | 15X10 MM (SİDEM) İÇ KÖŞE | 1 | ad. | 29,30 |
| 001 029 015010 00 XX | 15X10 MM (SİDEM) DIŞ KÖŞE | 1 | ad. | 29,30 |
| 001 030 015010 00 XX | 15X10 MM (SİDEM) T KÖŞE | 1 | ad. | 44,10 |
| 001 031 015010 00 XX | 15X10 MM (SİDEM) 90 L KÖŞE | 1 | ad. | 44,10 |
| 001 033 015010 00 XX | 15X10 MM (SİDEM) UÇ TAPA | 1 | ad. | 25,80 |
| 001 032 015010 00 XX | 15X10 MM (SİDEM) EK PARÇASI | 1 | ad. | 25,80 |





| Ürün Kodu | Ürün Adı | Amb. Birimi (Kutu) | Amb. Birimi | Fiyat (₺) |
|---|------------------------------|--------------------|-------------|-----------|
| 16x16 KANAL AKSESUARLARI - SİDEM SERİSİ | | | | |
| C € | | | | |
| 001 028 016016 00 XX | 16x16 MM (SİDEM) İÇ KÖŞE | 1 | ad. | 28,10 |
| 001 029 016016 00 XX | 16x16 MM (SİDEM) DIŞ KÖŞE | 1 | ad. | 28,10 |
| 001 030 016016 00 XX | 16x16 MM (SİDEM) T KÖŞE | 1 | ad. | 53,20 |
| 001 031 016016 00 XX | 16x16 MM (SİDEM) 90 L KÖŞE | 1 | ad. | 53,20 |
| 001 033 016016 00 XX | 16x16 MM (SİDEM) UÇ TAPA | 1 | ad. | 26,50 |
| 001 032 016016 00 XX | 16x16 MM (SİDEM) EK PARÇASI | 1 | ad. | 26,50 |
| 20x10 KANAL AKSESUARLARI - SİDEM SERİSİ | | | | |
| C € | | | | |
| 001 028 020010 00 XX | 20x10 MM (SİDEM) İÇ KÖŞE | 1 | ad. | 41,90 |
| 001 029 020010 00 XX | 20x10 MM (SİDEM) DIŞ KÖŞE | 1 | ad. | 41,90 |
| 001 030 020010 00 XX | 20x10 MM (SİDEM) T KÖŞE | 1 | ad. | 43,80 |
| 001 031 020010 00 XX | 20x10 MM (SİDEM) 90 L KÖŞE | 1 | ad. | 43,80 |
| 001 033 020010 00 XX | 20x10 MM (SİDEM) UÇ TAPA | 1 | ad. | 29,70 |
| 001 032 020010 00 XX | 20x10 MM (SİDEM) EK PARÇASI | 1 | ad. | 29,70 |
| TAVAN KÖŞE KANALI (23x23) AKSESUARLARI -SİDEM SERİSİ | | | | |
| C € | | | | |
| 001 041 023023 00 XX | 23X23 MM T PARÇASI | 1 | ad. | 122,30 |
| 001 042 023023 00 XX | 23X23 MM 90 L KÖŞE | 1 | ad. | 122,30 |
| 001 043 023023 00 XX | 23X23 MM EK PARÇA | 1 | ad. | 31,80 |
| 001 044 023023 00 XX | 23X23 MM UÇ TAPA | 1 | ad. | 31,80 |
| 25x16 KANAL AKSESUARLARI - SİDEM SERİSİ | | | | |
| C € | | | | |
| 001 028 025016 00 XX | 25X16 MM (SİDEM) İÇ KÖŞE | 1 | ad. | 55,90 |
| 001 029 025016 00 XX | 25X16 MM (SİDEM) DIŞ KÖŞE | 1 | ad. | 55,90 |
| 001 030 025016 00 XX | 25X16 MM (SİDEM) T KÖŞE | 1 | ad. | 60,10 |
| 001 031 025016 00 XX | 25X16 MM (SİDEM) 90 L KÖŞE | 1 | ad. | 60,10 |
| 001 033 025016 00 XX | 25X16 MM (SİDEM) UÇ TAPA | 1 | ad. | 36,70 |
| 001 032 025016 00 XX | 25X16 MM (SİDEM) EK PARÇA | 1 | ad. | 36,70 |
| 001 034 017421 00 XX | 25X16 MM (SİDEM) PMK (45X45) | 1 | ad. | 562,10 |
| 25x25 KANAL AKSESUARLARI - SİDEM SERİSİ | | | | |
| C € | | | | |
| 001 028 025025 00 XX | 25x25 MM (SİDEM) İÇ KÖŞE | 1 | ad. | 42,10 |
| 001 029 025025 00 XX | 25x25 MM (SİDEM) DIŞ KÖŞE | 1 | ad. | 42,10 |
| 001 030 025025 00 XX | 25x25 MM (SİDEM) T PARÇASI | 1 | ad. | 56,40 |
| 001 031 025025 00 XX | 25x25 MM (SİDEM) 90 L KÖŞE | 1 | ad. | 56,40 |
| 001 033 025025 00 XX | 25x25 MM (SİDEM) UÇ TAPA | 1 | ad. | 30,50 |
| 001 032 025025 00 XX | 25x25 MM (SİDEM) EK PARÇA | 1 | ad. | 30,50 |
| 001 034 017421 00 XX | 25x25 MM (SİDEM) PMK (45X45) | 1 | ad. | 562,10 |
| 30x10 KANAL AKSESUARLARI - SİDEM SERİSİ | | | | |
| C € | | | | |
| 001 028 030010 00 XX | 30X10 MM (SİDEM) İÇ KÖŞE | 1 | ad. | 56,00 |
| 001 029 030010 00 XX | 30X10 MM (SİDEM) DIŞ KÖŞE | 1 | ad. | 56,00 |
| 001 030 030010 00 XX | 30X10 MM (SİDEM) T PARÇASI | 1 | ad. | 70,90 |
| 001 031 030010 00 XX | 30X10 MM (SİDEM) 90 L KÖŞE | 1 | ad. | 70,90 |
| 001 033 030010 00 XX | 30X10 MM (SİDEM) UÇ TAPA | 1 | ad. | 32,90 |
| 001 032 030010 00 XX | 30X10 MM (SİDEM) EK PARÇA | 1 | ad. | 32,90 |
| 30x16 KANAL AKSESUARLARI - SİDEM SERİSİ | | | | |
| C € | | | | |
| 001 028 030016 00 XX | 30x16 MM (SİDEM) İÇ KÖŞE | 1 | ad. | 64,70 |
| 001 029 030016 00 XX | 30x16 MM (SİDEM) DIŞ KÖŞE | 1 | ad. | 64,70 |
| 001 030 030016 00 XX | 30x16 MM (SİDEM) T PARÇASI | 1 | ad. | 87,00 |
| 001 031 030016 00 XX | 30x16 MM (SİDEM) 90 L KÖŞE | 1 | ad. | 87,00 |
| 001 033 030016 00 XX | 30x16 MM (SİDEM) UÇ TAPA | 1 | ad. | 36,60 |
| 001 032 030016 00 XX | 30x16 MM (SİDEM) EK PARÇA | 1 | ad. | 36,60 |
| 30x25 KANAL AKSESUARLARI - SİDEM SERİSİ | | | | |
| C € | | | | |
| 001 028 030025 00 XX | 30X25 MM (SİDEM) İÇ KÖŞE | 1 | ad. | 63,00 |
| 001 029 030025 00 XX | 30X25 MM (SİDEM) DIŞ KÖŞE | 1 | ad. | 63,00 |
| 001 030 030025 00 XX | 30X25 MM (SİDEM) T PARÇASI | 1 | ad. | 88,10 |
| 001 031 030025 00 XX | 30X25 MM (SİDEM) 90 L KÖŞE | 1 | ad. | 88,10 |
| 001 033 030025 00 XX | 30X25 MM (SİDEM) UÇ TAPA | 1 | ad. | 38,40 |
| 001 032 030025 00 XX | 30X25 MM (SİDEM) EK PARÇA | 1 | ad. | 38,40 |
| 40x16 KANAL AKSESUARLARI - SİDEM SERİSİ | | | | |
| C € | | | | |
| 001 028 040016 00 XX | 40x16 MM (SİDEM) İÇ KÖŞE | 1 | ad. | 66,80 |
| 001 029 040016 00 XX | 40x16 MM (SİDEM) DIŞ KÖŞE | 1 | ad. | 66,80 |
| 001 030 040016 00 XX | 40x16 MM (SİDEM) T PARÇASI | 1 | ad. | 92,90 |
| 001 031 040016 00 XX | 40x16 MM (SİDEM) 90 L KÖŞE | 1 | ad. | 92,90 |
| 001 033 040016 00 XX | 40x16 MM (SİDEM) UÇ TAPA | 1 | ad. | 46,90 |
| 001 032 040016 00 XX | 40x16 MM (SİDEM) EK PARÇA | 1 | ad. | 46,90 |
| 001 034 017421 00 XX | 40X16 MM (SİDEM) PMK (45X45) | 1 | ad. | 562,10 |
| 40x25 KANAL AKSESUARLARI - SİDEM SERİSİ | | | | |
| C € | | | | |
| 001 028 040025 00 XX | 40X25 MM (SİDEM) İÇ KÖŞE | 1 | ad. | 77,30 |
| 001 029 040025 00 XX | 40X25 MM (SİDEM) DIŞ KÖŞE | 1 | ad. | 77,30 |
| 001 030 040025 00 XX | 40X25 MM (SİDEM) T KÖŞE | 1 | ad. | 96,60 |
| 001 031 040025 00 XX | 40X25 MM (SİDEM) 90 L KÖŞE | 1 | ad. | 96,60 |
| 001 033 040025 00 XX | 40X25 MM (SİDEM) UÇ TAPA | 1 | ad. | 51,60 |
| 001 032 040025 00 XX | 40X25 MM (SİDEM) EK PARÇASI | 1 | ad. | 51,60 |
| 001 034 017421 00 XX | 40X25 MM (SİDEM) PMK (45X45) | 1 | ad. | 562,10 |

| Ürün Kodu | Ürün Adı | Amb. (Kutu) | Amb. Birimi | Fiyat (₺) |
|--|-------------------------------------|-------------|-------------|-----------|
| 40x40 KANAL AKSESUARLARI - SİDEM SERİSİ | | | | |
| € € | | | | |
| 001 028 040040 00 XX | 40x40 MM (SİDEM) İÇ KÖŞE | 1 | ad. | 81,70 |
| 001 029 040040 00 XX | 40x40 MM (SİDEM) DIŞ KÖŞE | 1 | ad. | 81,70 |
| 001 030 040040 00 XX | 40x40 MM (SİDEM) T KÖŞE | 1 | ad. | 85,80 |
| 001 031 040040 00 XX | 40x40 MM (SİDEM) 90 L KÖŞE | 1 | ad. | 85,70 |
| 001 033 040040 00 XX | 40x40 MM (SİDEM) UÇ TAPA | 1 | ad. | 62,20 |
| 001 032 040040 00 XX | 40x40 MM (SİDEM) EK PARÇASI | 1 | ad. | 62,20 |
| 001 034 017421 00 XX | 40x40 MM (SİDEM) PMK (45X45) | 1 | ad. | 562,10 |
| 60x25 KANAL AKSESUARLARI - SİDEM SERİSİ | | | | |
| € € | | | | |
| 001 028 060025 00 XX | 60x25 MM (SİDEM) İÇ KÖŞE | 1 | ad. | 86,00 |
| 001 029 060025 00 XX | 60x25 MM (SİDEM) DIŞ KÖŞE | 1 | ad. | 86,00 |
| 001 030 060025 00 XX | 60x25 MM (SİDEM) T KÖŞE | 1 | ad. | 92,60 |
| 001 031 060025 00 XX | 60x25 MM (SİDEM) 90 L KÖŞE | 1 | ad. | 92,60 |
| 001 033 060025 00 XX | 60x25 MM (SİDEM) UÇ TAPA | 1 | ad. | 62,60 |
| 001 032 060025 00 XX | 60x25 MM (SİDEM) EK PARÇASI | 1 | ad. | 62,60 |
| 60x40 KANAL AKSESUARLARI - SİDEM SERİSİ | | | | |
| € € | | | | |
| 001 028 060040 00 XX | 60x40 MM (SİDEM) İÇ KÖŞE | 1 | ad. | 87,00 |
| 001 029 060040 00 XX | 60x40 MM (SİDEM) DIŞ KÖŞE | 1 | ad. | 87,00 |
| 001 030 060040 00 XX | 60x40 MM (SİDEM) T KÖŞE | 1 | ad. | 91,30 |
| 001 031 060040 00 XX | 60x40 MM (SİDEM) 90 L KÖŞE | 1 | ad. | 91,30 |
| 001 033 060040 00 XX | 60x40 MM (SİDEM) UÇ TAPA | 1 | ad. | 63,50 |
| 001 032 060040 00 XX | 60x40 MM (SİDEM) EK PARÇA | 1 | ad. | 63,50 |
| 60x60 KANAL AKSESUARLARI - SİDEM SERİSİ | | | | |
| € € | | | | |
| 001 028 060060 00 XX | 60x60 MM (SİDEM) İÇ KÖŞE | 1 | ad. | 108,20 |
| 001 029 060060 00 XX | 60x60 MM (SİDEM) DIŞ KÖŞE | 1 | ad. | 108,20 |
| 001 030 060060 00 XX | 60x60 MM (SİDEM) T PARÇASI | 1 | ad. | 124,50 |
| 001 031 060060 00 XX | 60x60 MM (SİDEM) 90 L KÖŞE | 1 | ad. | 124,50 |
| 001 033 060060 00 XX | 60x60 MM (SİDEM) UÇ TAPA | 1 | ad. | 74,20 |
| 001 032 060060 00 XX | 60x60 MM (SİDEM) EK PARÇA | 1 | ad. | 74,20 |
| 74x20 KANAL AKSESUARLARI - SİDEM SERİSİ | | | | |
| € € | | | | |
| 001 028 074020 00 XX | 74x20 MM (SİDEM) İÇ KÖŞE | 1 | ad. | 90,10 |
| 001 029 074020 00 XX | 74x20 MM (SİDEM) DIŞ KÖŞE | 1 | ad. | 90,10 |
| 001 030 074020 00 XX | 74x20 MM (SİDEM) T PARÇASI | 1 | ad. | 94,00 |
| 001 031 074020 00 XX | 74x20 MM (SİDEM) 90 L KÖŞE | 1 | ad. | 94,00 |
| 001 032 074020 00 XX | 74x20 MM (SİDEM) UÇ TAPA | 1 | ad. | 85,30 |
| 001 033 074020 00 XX | 74x20 MM (SİDEM) EK PARÇA | 1 | ad. | 85,30 |
| 001 036 017420 00 XX | 74x20 MM (SİDEM) PRİZ MONTAJ KASASI | 1 | ad. | 922,70 |
| 75x22 KANAL AKSESUARLARI - SİDEM SERİSİ | | | | |
| € € | | | | |
| 001 028 075022 00 XX | 75x22 MM (SİDEM) İÇ KÖŞE | 1 | ad. | 83,00 |
| 001 029 075022 00 XX | 75x22 MM (SİDEM) DIŞ KÖŞE | 1 | ad. | 83,00 |
| 001 033 075022 01 XX | 75x22 MM (SİDEM) SAĞ SONLAMA | 1 | ad. | 113,80 |
| 001 033 075022 02 XX | 75x22 MM (SİDEM) SOL SONLAMA | 1 | ad. | 113,80 |
| 001 032 075022 00 XX | 75x22 MM (SİDEM) EK PARÇASI | 1 | ad. | 75,30 |
| 80x40 KANAL AKSESUARLARI - SİDEM SERİSİ | | | | |
| € € | | | | |
| 001 028 080040 00 XX | 80x40 MM (SİDEM) İÇ KÖŞE | 1 | ad. | 106,00 |
| 001 029 080040 00 XX | 80x40 MM (SİDEM) DIŞ KÖŞE | 1 | ad. | 106,00 |
| 001 030 080040 00 XX | 80x40 MM (SİDEM) T PARÇASI | 1 | ad. | 116,00 |
| 001 031 080040 00 XX | 80x40 MM (SİDEM) 90 L KÖŞE | 1 | ad. | 116,00 |
| 001 033 080040 00 XX | 80x40 MM (SİDEM) UÇ TAPA | 1 | ad. | 97,90 |
| 001 032 080040 00 XX | 80x40 MM (SİDEM) EK PARÇA | 1 | ad. | 97,90 |
| 80x60 KANAL AKSESUARLARI - SİDEM SERİSİ | | | | |
| € € | | | | |
| 001 028 080060 00 XX | 80x60 MM (SİDEM) İÇ KÖŞE | 1 | ad. | 138,10 |
| 001 029 080060 00 XX | 80x60 MM (SİDEM) DIŞ KÖŞE | 1 | ad. | 138,10 |
| 001 030 080060 00 XX | 80x60 MM (SİDEM) T PARÇASI | 1 | ad. | 120,80 |
| 001 031 080060 00 XX | 80x60 MM (SİDEM) 90 L KÖŞE | 1 | ad. | 120,80 |
| 001 033 080060 00 XX | 80x60 MM (SİDEM) UÇ TAPA | 1 | ad. | 86,80 |
| 001 032 080060 00 XX | 80x60 MM (SİDEM) EK PARÇA | 1 | ad. | 86,80 |



İÇ KÖŞE



DIŞ KÖŞE



T KÖŞE

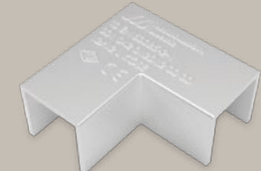

L KÖŞE



EK PARÇA



UÇ TAPA



İÇ KÖŞE



DIŞ KÖŞE



T KÖŞE

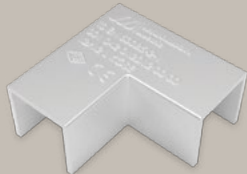

L KÖŞE



| Ürün Kodu | Ürün Adı | Amb. Birimi (Kutu) | Amb. Birimi | Fiyat (₺) |
|---|--|--------------------|-------------|-----------|
| 100x37 KANAL AKSESUARLARI - SİDEM SERİSİ | | | | |
| € € | | | | |
| 001 028 100037 00 XX | 100X37 MM (SİDEM) İÇ KÖŞE (SABİT) | 1 | ad. | 170,30 |
| 001 029 100037 00 XX | 100X37 MM (SİDEM) DIŞ KÖŞE (SABİT) | 1 | ad. | 170,30 |
| 001 028 100037 01 XX | 100X37 MM (SİDEM) İÇ KÖŞE (HAREKETLİ) | 1 | ad. | 170,30 |
| 001 029 100037 01 XX | 100X37 MM (SİDEM) DIŞ KÖŞE (HAREKETLİ) | 1 | ad. | 170,30 |
| 001 030 100037 00 XX | 100X37 MM (SİDEM) T PARÇASI | 1 | ad. | 181,50 |
| 001 031 100037 00 XX | 100X37 MM (SİDEM) 90 L KÖŞE | 1 | ad. | 181,50 |
| 001 033 100037 00 XX | 100X37 MM (SİDEM) UÇ TAPA | 1 | ad. | 118,90 |
| 001 032 100037 00 XX | 100X37 MM (SİDEM) EK PARÇA | 1 | ad. | 118,90 |
| 100x40 KANAL AKSESUARLARI - SİDEM SERİSİ | | | | |
| € € | | | | |
| 001 028 100040 00 XX | 100X40 MM (SİDEM) İÇ KÖŞE (SABİT) | 1 | ad. | 177,60 |
| 001 029 100040 00 XX | 100X40 MM (SİDEM) DIŞ KÖŞE (SABİT) | 1 | ad. | 177,60 |
| 001 028 100040 01 XX | 100X40 MM (SİDEM) İÇ KÖŞE (HAREKETLİ) | 1 | ad. | 177,60 |
| 001 029 100040 01 XX | 100X40 MM (SİDEM) DIŞ KÖŞE (HAREKETLİ) | 1 | ad. | 177,60 |
| 001 030 100040 00 XX | 100X40 MM (SİDEM) T PARÇASI | 1 | ad. | 184,70 |
| 001 031 100040 00 XX | 100X40 MM (SİDEM) 90 L KÖŞE | 1 | ad. | 184,70 |
| 001 033 100040 00 XX | 100X40 MM (SİDEM) UÇ TAPA | 1 | ad. | 120,80 |
| 001 032 100040 00 XX | 100X40 MM (SİDEM) EK PARÇA | 1 | ad. | 120,80 |
| 100x48 KANAL AKSESUARLARI - SİDEM SERİSİ | | | | |
| € € | | | | |
| 001 028 100048 00 XX | 100X48 MM (SİDEM) İÇ KÖŞE (SABİT) | 1 | ad. | 191,80 |
| 001 029 100048 00 XX | 100X48 MM (SİDEM) DIŞ KÖŞE (SABİT) | 1 | ad. | 191,80 |
| 001 028 100048 01 XX | 100X48 MM (SİDEM) İÇ KÖŞE (HAREKETLİ) | 1 | ad. | 191,80 |
| 001 029 100048 01 XX | 100X48 MM (SİDEM) DIŞ KÖŞE (HAREKETLİ) | 1 | ad. | 191,80 |
| 001 030 100048 00 XX | 100X48 MM (SİDEM) T PARÇASI | 1 | ad. | 198,50 |
| 001 031 100048 00 XX | 100X48 MM (SİDEM) 90 L KÖŞE | 1 | ad. | 198,50 |
| 001 033 100048 00 XX | 100X48 MM (SİDEM) UÇ TAPA | 1 | ad. | 128,40 |
| 001 032 100048 00 XX | 100X48 MM (SİDEM) EK PARÇA | 1 | ad. | 128,40 |
| 100x50 KANAL AKSESUARLARI - SİDEM SERİSİ | | | | |
| € € | | | | |
| 001 028 100050 00 XX | 100X50 MM (SİDEM) İÇ KÖŞE (SABİT) | 1 | ad. | 204,50 |
| 001 029 100050 00 XX | 100X50 MM (SİDEM) DIŞ KÖŞE (SABİT) | 1 | ad. | 204,50 |
| 001 028 100050 01 XX | 100X50 MM (SİDEM) İÇ KÖŞE (HAREKETLİ) | 1 | ad. | 204,50 |
| 001 029 100050 01 XX | 100X50 MM (SİDEM) DIŞ KÖŞE (HAREKETLİ) | 1 | ad. | 204,50 |
| 001 030 100050 00 XX | 100X50 MM (SİDEM) T PARÇASI | 1 | ad. | 209,10 |
| 001 031 100050 00 XX | 100X50 MM (SİDEM) 90 L KÖŞE | 1 | ad. | 209,10 |
| 001 033 100050 00 XX | 100X50 MM (SİDEM) UÇ TAPA | 1 | ad. | 135,90 |
| 001 032 100050 00 XX | 100X50 MM (SİDEM) EK PARÇA | 1 | ad. | 135,90 |
| 100x60 KANAL AKSESUARLARI - SİDEM SERİSİ | | | | |
| € € | | | | |
| 001 028 100060 00 XX | 100X60 MM (SİDEM) İÇ KÖŞE (SABİT) | 1 | ad. | 230,80 |
| 001 029 100060 00 XX | 100X60 MM (SİDEM) DIŞ KÖŞE (SABİT) | 1 | ad. | 230,80 |
| 001 028 100060 01 XX | 100X60 MM (SİDEM) İÇ KÖŞE (HAREKETLİ) | 1 | ad. | 230,80 |
| 001 029 100060 01 XX | 100X60 MM (SİDEM) DIŞ KÖŞE (HAREKETLİ) | 1 | ad. | 230,80 |
| 001 030 100060 00 XX | 100X60 MM (SİDEM) T PARÇASI | 1 | ad. | 251,40 |
| 001 031 100060 00 XX | 100X60 MM (SİDEM) 90 L KÖŞE | 1 | ad. | 251,40 |
| 001 033 100060 00 XX | 100X60 MM (SİDEM) UÇ TAPA | 1 | ad. | 148,90 |
| 001 032 100060 00 XX | 100X60 MM (SİDEM) EK PARÇA | 1 | ad. | 148,90 |
| İÇTEN KAPAKLI 100x37/50 İÇİN PMS - SİDEM SERİSİ | | | | |
| € € | | | | |
| 001 034 400001 00 XX | 100X37/50 (SİDEM) 45X45 PMS TEKLİ | 1 | ad. | 112,90 |
| 001 034 400002 00 XX | 100X37/50 (SİDEM) 45X45 PMS İKİLİ | 1 | ad. | 120,50 |
| 001 034 400003 00 XX | 100X37/50 (SİDEM) 45X45 PMS ÜÇLÜ | 1 | ad. | 126,50 |
| 001 034 400004 00 XX | 100X37/50 (SİDEM) 45X45 PMS DÖRTLÜ | 1 | ad. | 191,50 |
| 001 034 500001 00 XX | 100X37/50 (SİDEM) 55X55 PMS TEKLİ | 1 | ad. | 161,60 |
| 001 034 500002 00 XX | 100X37/50 (SİDEM) 55X55 PMS İKİLİ | 1 | ad. | 186,20 |
| 001 034 500003 00 XX | 100X37/50 (SİDEM) 55X55 PMS ÜÇLÜ | 1 | ad. | 201,70 |
| DIŞTAN KAPAKLI 100'LÜK PMS 55x55 İÇİN - SİDEM SERİSİ | | | | |
| € € | | | | |
| 001 034 000001 00 XX | 100'LÜK 55X55 PMS TEKLİ SİDEM | 1 | ad. | 210,50 |
| 001 034 000002 00 XX | 100'LÜK 55X55 PMS İKİLİ SİDEM | 1 | ad. | 257,10 |
| 001 034 000003 00 XX | 100'LÜK 55X55 PMS ÜÇLÜ SİDEM | 1 | ad. | 291,70 |
| DIŞTAN KAPAKLI 100'LÜK PMS 45x45 İÇİN - SİDEM SERİSİ | | | | |
| € € | | | | |
| 001 034 100001 00 XX | 100'LÜK 45X45 PMS TEKLİ SİDEM | 1 | ad. | 136,00 |
| 001 034 100002 00 XX | 100'LÜK 45X45 PMS İKİLİ SİDEM | 1 | ad. | 174,10 |
| 001 034 100003 00 XX | 100'LÜK 45X45 PMS ÜÇLÜ SİDEM | 1 | ad. | 247,90 |
| 001 034 100004 00 XX | 100'LÜK 45X45 PMS DÖRTLÜ SİDEM | 1 | ad. | 263,10 |

*Kutusuz ürünlerde topraklama klemensi bulunmamaktadır.

| Ürün Kodu | Ürün Adı | Kutu Adet | Koli Adet | Normal Fiyat (₺) | Kutusuz ve Klemensiz Fiyat (₺) |
|---|---|-----------|-----------|------------------|--------------------------------|
| COMFORT W OTOMAT KUTULARI | | | | | |
| IP40 | | | | | |
| 001 057 200001 00 00 | COMFORT MÜH. SİGORTA KUTUSU(S/Ü) 1 Lİ | 20 | 120 | 29,60 | - |
| 001 057 200002 00 00 | COMFORT MÜH. SİGORTA KUTUSU(S/Ü) 1-2 Lİ | 20 | 80 | 33,30 | - |
| 001 057 200004 00 00 | COMFORT MÜH. SİGORTA KUTUSU(S/Ü) 2-4 Lİ | 10 | 60 | 53,00 | - |
| 001 057 100006 00 00 | COMFORT SİGORTA KUTUSU (S/Ü) 6 Lİ | 1 | 20 | 277,80 | 214,40 |
| 001 057 100009 00 00 | COMFORT SİGORTA KUTUSU (S/Ü) 9 LU | 1 | 20 | 351,90 | 272,70 |
| 001 057 100012 00 00 | COMFORT SİGORTA KUTUSU (S/Ü) 12 Lİ | 1 | 10 | 422,20 | 340,10 |
| 001 057 100018 00 00 | COMFORT SİGORTA KUTUSU (S/Ü) 18 Lİ | 1 | 10 | 577,80 | 458,40 |
| 001 057 100024 00 00 | COMFORT SİGORTA KUTUSU (S/Ü) 24 LÜ | 1 | 5 | 744,40 | 593,70 |
| 001 057 100036 00 00 | COMFORT SİGORTA KUTUSU (S/Ü) 36 Lİ | 1 | 5 | 933,30 | 786,80 |
| 001 057 000006 00 00 | COMFORT SİGORTA KUTUSU (S/A) 6 Lİ | 1 | 20 | 277,80 | 214,40 |
| 001 057 000009 00 00 | COMFORT SİGORTA KUTUSU (S/A) 9 LU | 1 | 20 | 351,90 | 272,70 |
| 001 057 000012 00 00 | COMFORT SİGORTA KUTUSU (S/A) 12 Lİ | 1 | 10 | 422,20 | 340,10 |
| 001 057 000018 00 00 | COMFORT SİGORTA KUTUSU (S/A) 18 Lİ | 1 | 10 | 577,80 | 458,40 |
| 001 057 000024 00 00 | COMFORT SİGORTA KUTUSU (S/A) 24 LÜ | 1 | 5 | 744,40 | 593,70 |
| 001 057 000036 00 00 | COMFORT SİGORTA KUTUSU (S/A) 36 Lİ | 1 | 5 | 933,30 | 786,80 |
| COMFORT W OTOMAT KUTULARI - ALEV YAYMAYAN | | | | | |
| IP40 | | | | | |
| 001 057 210001 00 00 | COMFORT MÜH. SİGORTA (A.YAYMAYAN)(S/Ü) 1 Lİ | 20 | 120 | 75,90 | - |
| 001 057 210002 00 00 | COMFORT MÜH. SİGORTA (A.YAYMAYAN)(S/Ü) 1-2 Lİ | 20 | 80 | 91,20 | - |
| 001 057 210004 00 00 | COMFORT MÜH. SİGORTA (A.YAYMAYAN)(S/Ü) 2-4 LÜ | 10 | 60 | 109,50 | - |
| 001 057 110006 00 00 | COMFORT SİGORTA KUTUSU(S/Ü)(A.YAYMAYAN) 6 Lİ | 1 | 20 | 471,30 | - |
| 001 057 110009 00 00 | COMFORT SİGORTA KUTUSU(S/Ü)(A.YAYMAYAN) 9 LU | 1 | 20 | 580,30 | - |
| 001 057 110012 00 00 | COMFORT SİGORTA KUTUSU(S/Ü)(A.YAYMAYAN) 12 Lİ | 1 | 10 | 763,00 | - |
| 001 057 110018 00 00 | COMFORT SİGORTA KUTUSU(S/Ü)(A.YAYMAYAN) 18 Lİ | 1 | 10 | 1.088,60 | - |
| 001 057 110024 00 00 | COMFORT SİGORTA KUTUSU(S/Ü)(A.YAYMAYAN) 24 LÜ | 1 | 5 | 1.206,30 | - |
| 001 057 110036 00 00 | COMFORT SİGORTA KUTUSU(S/Ü)(A.YAYMAYAN) 36 Lİ | 1 | 5 | 1.611,70 | - |
| 001 057 010006 00 00 | COMFORT SİGORTA KUTUSU(S/A) A.YAYMAYAN 6 Lİ | 1 | 20 | 471,30 | - |
| 001 057 010009 00 00 | COMFORT SİGORTA KUTUSU(S/A) A.YAYMAYAN 9 LU | 1 | 20 | 580,30 | - |
| 001 057 010012 00 00 | COMFORT SİGORTA KUTUSU(S/A) A.YAYMAYAN 12 Lİ | 1 | 10 | 763,00 | - |
| 001 057 010018 00 00 | COMFORT SİGORTA KUTUSU(S/A) A.YAYMAYAN 18 Lİ | 1 | 10 | 1.088,60 | - |
| 001 057 010024 00 00 | COMFORT SİGORTA KUTUSU(S/A) A.YAYMAYAN 24 LÜ | 1 | 5 | 1.206,30 | - |
| 001 057 010036 00 00 | COMFORT SİGORTA KUTUSU(S/A) A.YAYMAYAN 36 Lİ | 1 | 5 | 1.611,70 | - |
| COMFORT W OTOMAT KUTULARI - HALOJEN FREE - ALEV YAYAN | | | | | |
| IP40 | | | | | |
| 001 057 220001 00 00 | COMFORT MÜH. SİGORTA KUTUSU H.FREE (ALEV YAYAN)(S/Ü)1 Lİ | 20 | 120 | 44,40 | - |
| 001 057 220002 00 00 | COMFORT MÜH. SİGORTA KUTUSU H.FREE (ALEV YAYAN)(S/Ü)1-2 Lİ | 20 | 80 | 55,60 | - |
| 001 057 220004 00 00 | COMFORT MÜH. SİGORTA KUTUSU H.FREE (ALEV YAYAN)(S/Ü)2-4 Lİ | 10 | 60 | 70,40 | - |
| 001 057 120006 00 00 | COMFORT SİGORTA KUTUSU H.FREE (ALEV YAYAN) (S/Ü) 6 Lİ | 1 | 20 | 325,90 | - |
| 001 057 120009 00 00 | COMFORT SİGORTA KUTUSU H.FREE (ALEV YAYAN) (S/Ü) 9 LU | 1 | 20 | 385,20 | - |
| 001 057 120012 00 00 | COMFORT SİGORTA KUTUSU H.FREE (ALEV YAYAN) (S/Ü) 12 Lİ | 1 | 10 | 518,50 | - |
| 001 057 120018 00 00 | COMFORT SİGORTA KUTUSU H.FREE (ALEV YAYAN) (S/Ü) 18 Lİ | 1 | 10 | 714,80 | - |
| 001 057 120024 00 00 | COMFORT SİGORTA KUTUSU H.FREE (ALEV YAYAN) (S/Ü) 24 LÜ | 1 | 5 | 937,00 | - |
| 001 057 120036 00 00 | COMFORT SİGORTA KUTUSU H.FREE (ALEV YAYAN) (S/Ü) 36 Lİ | 1 | 5 | 1.018,50 | - |
| 001 057 020006 00 00 | COMFORT SİGORTA KUTUSU H.FREE (ALEV YAYAN) (S/A) 6 Lİ | 1 | 20 | 325,90 | - |
| 001 057 020009 00 00 | COMFORT SİGORTA KUTUSU H.FREE (ALEV YAYAN) (S/A) 9 LU | 1 | 20 | 385,20 | - |
| 001 057 020012 00 00 | COMFORT SİGORTA KUTUSU H.FREE (ALEV YAYAN) (S/A) 12 Lİ | 1 | 10 | 518,50 | - |
| 001 057 020018 00 00 | COMFORT SİGORTA KUTUSU H.FREE (ALEV YAYAN) (S/A) 18 Lİ | 1 | 10 | 714,80 | - |
| 001 057 020024 00 00 | COMFORT SİGORTA KUTUSU H.FREE (ALEV YAYAN) (S/A) 24 LÜ | 1 | 5 | 937,00 | - |
| 001 057 020036 00 00 | COMFORT SİGORTA KUTUSU H.FREE (ALEV YAYAN) (S/A) 36 Lİ | 1 | 5 | 1.018,50 | - |
| COMFORT W OTOMAT ZAYIF AKIM KUTULARI | | | | | |
| IP40 | | | | | |
| 001 057 101012 00 00 | COMFORT ZAYIF AKIM KUTUSU (S/Ü)(225x270) | 1 | 10 | 372,60 | - |
| 001 057 101020 00 00 | COMFORT ZAYIF AKIM KUTUSU (S/Ü)(270x340) | 1 | 5 | 628,80 | - |
| 001 057 101024 00 00 | COMFORT 12 Lİ SİGORTA + ZAYIF AKIM KUTUSU (S/Ü) | 1 | 5 | 674,00 | - |
| 001 057 101036 00 00 | COMFORT 24 LÜ SİGORTA + ZAYIF AKIM KUTUSU (S/Ü) | 1 | 5 | 851,90 | - |
| 001 057 001012 00 00 | COMFORT ZAYIF AKIM KUTUSU (S/A)(205x250) | 1 | 10 | 368,30 | - |
| 001 057 001020 00 00 | COMFORT ZAYIF AKIM KUTUSU (S/A)(248x318) | 1 | 5 | 628,10 | - |
| 001 057 001024 00 00 | COMFORT 12 Lİ SİGORTA + ZAYIF AKIM KUTUSU (S/A) | 1 | 5 | 671,20 | - |
| 001 057 001036 00 00 | COMFORT 24 LÜ SİGORTA + ZAYIF AKIM KUTUSU (S/A) | 1 | 5 | 863,90 | - |
| COMFORT W OTOMAT ZAYIF AKIM KUTULARI - HALOJEN FREE - ALEV YAYAN | | | | | |
| IP40 | | | | | |
| 001 057 121012 00 00 | COMFORT ZAYIF AKIM KUTUSU H.FREE (ALEV YAYAN) (S/Ü)(225x270) | 1 | 10 | 482,20 | - |
| 001 057 121020 00 00 | COMFORT ZAYIF AKIM KUTUSU H.FREE (ALEV YAYAN) (S/Ü)(270x340) | 1 | 5 | 788,10 | - |
| 001 057 121024 00 00 | COMFORT 12 Lİ SİGORTA + ZAYIF AKIM KUTUSU H.FREE (ALEV YAYAN) (S/Ü) | 1 | 5 | 850,40 | - |
| 001 057 121036 00 00 | COMFORT 24 LÜ SİGORTA + ZAYIF AKIM KUTUSU H.FREE (ALEV YAYAN) (S/Ü) | 1 | 5 | 1.033,70 | - |
| 001 057 021012 00 00 | COMFORT ZAYIF AKIM KUTUSU H.FREE (ALEV YAYAN) (S/A)(205x250) | 1 | 10 | 473,70 | - |
| 001 057 021020 00 00 | COMFORT ZAYIF AKIM KUTUSU H.FREE (ALEV YAYAN) (S/A)(248x318) | 1 | 5 | 617,90 | - |
| 001 057 021024 00 00 | COMFORT 12 Lİ SİGORTA + ZAYIF AKIM KUTUSU H.FREE (ALEV YAYAN) (S/A) | 1 | 5 | 835,60 | - |
| 001 057 021036 00 00 | COMFORT 24 LÜ SİGORTA + ZAYIF AKIM KUTUSU H.FREE (ALEV YAYAN) (S/A) | 1 | 5 | 1.021,60 | - |
| COMFORT W OTOMAT ZAYIF AKIM KUTULARI - ALEV YAYMAYAN | | | | | |
| IP40 | | | | | |
| 001 057 111012 00 00 | COMFORT ZAYIF AKIM KUTUSU(A.YAYMAYAN)(S/Ü)(225x270) | 1 | 10 | 647,90 | - |
| 001 057 111020 00 00 | COMFORT ZAYIF AKIM KUTUSU(A.YAYMAYAN)(S/Ü)(270x340) | 1 | 5 | 1.043,50 | - |
| 001 057 111024 00 00 | COMFORT 12 Lİ SİGORTA + ZAYIF AKIM KUTUSU(A.YAYMAYAN)(S/Ü) | 1 | 5 | 1.028,80 | - |
| 001 057 111036 00 00 | COMFORT 24 LÜ SİGORTA + ZAYIF AKIM KUTUSU(A.YAYMAYAN)(S/Ü) | 1 | 5 | 1.305,70 | - |
| 001 057 011012 00 00 | COMFORT ZAYIF AKIM KUTUSU(A.YAYMAYAN)(S/A)(205x250) | 1 | 10 | 609,40 | - |
| 001 057 011020 00 00 | COMFORT ZAYIF AKIM KUTUSU(A.YAYMAYAN)(S/A)(248x318) | 1 | 5 | 988,90 | - |
| 001 057 011024 00 00 | COMFORT 12 Lİ SİGORTA + ZAYIF AKIM KUTUSU(A.YAYMAYAN)(S/A) | 1 | 5 | 973,30 | - |
| 001 057 011036 00 00 | COMFORT 24 LÜ SİGORTA + ZAYIF AKIM KUTUSU(A.YAYMAYAN)(S/A) | 1 | 5 | 1.256,30 | - |
| COMFORT W OTOMAT KUTUSU AKSESUARLARI | | | | | |
| 001 057 990001 00 00 | S/A COMFORT ALÇIPAN MONTAJ SETİ | 1 | | 37,70 | - |
| 001 057 990002 00 00 | COMFORT SU TERAZİSİ | 1 | | 55,00 | - |
| 000 700 000574 00 00 | RAY YÜKSELTME PARÇASI (UZUN/KISA) | 1 | | 6,50 | - |
| 001 057 001236 00 00 | COMFORT ZAYIF AKIM ÖRTME PARÇASI | 50 | | 40,70 | - |



Sıva altı serisinde **beton, alçıpan** duvarlara montaj yapılabilmeye özelliği.





| Ürün Kodu | Ürün Adı | Kutu Adet | Koli Adet | Kutu Fiyat (₺) |
|--|--|-----------|-----------|----------------|
| W OTOMAT ÖRTME PARÇALARI | | | | |
| 001 026 000002 00 00 | W OTOMAT ÖRTME PARÇASI 12'Lİ - YENİ TİP | 50 | 400 | 24,40 |
| MEKSBOX W OTOMAT KUTULARI | | | | |
| IP30 | | | | |
| 001 027 200001 00 00 | MÜHÜRLÜ W OTOMAT KUTUSU (S/Ü) 1 Lİ | 20 | 160 | 27,00 |
| 001 027 200002 00 00 | MÜHÜRLÜ W OTOMAT KUTUSU (S/Ü) 2 Lİ | 20 | 80 | 31,70 |
| 001 027 200004 00 00 | MÜHÜRLÜ W OTOMAT KUTUSU (S/Ü) 4 LÜ | 10 | 80 | 50,90 |
| 001 027 100002 00 00 | W OTOMAT KUTUSU (S/Ü) MEKSBOX 2 Lİ | 1 | 30 | 213,00 |
| 001 027 000002 00 00 | W OTOMAT KUTUSU (S/A) MEKSBOX 2 Lİ | 1 | 30 | 213,00 |
| 001 027 100004 00 00 | W OTOMAT KUTUSU (S/Ü) MEKSBOX 4 LÜ | 1 | 20 | 227,80 |
| 001 027 000004 00 00 | W OTOMAT KUTUSU (S/A) MEKSBOX 4 LÜ | 1 | 20 | 227,80 |
| 001 027 100006 00 00 | W OTOMAT KUTUSU (S/Ü) MEKSBOX 6 Lİ | 1 | 20 | 270,40 |
| 001 027 000006 00 00 | W OTOMAT KUTUSU (S/A) MEKSBOX 6 Lİ | 1 | 20 | 270,40 |
| 001 027 100009 00 00 | W OTOMAT KUTUSU (S/Ü) MEKSBOX 9 LU | 1 | 20 | 343,00 |
| 001 027 000009 00 00 | W OTOMAT KUTUSU (S/A) MEKSBOX 9 LU | 1 | 20 | 343,00 |
| 001 027 100012 00 00 | W OTOMAT KUTUSU (S/Ü) MEKSBOX 12 Lİ | 1 | 10 | 416,70 |
| 001 027 000012 00 00 | W OTOMAT KUTUSU (S/A) MEKSBOX 12 Lİ | 1 | 10 | 416,70 |
| 001 027 100016 00 00 | W OTOMAT KUTUSU (S/Ü) MEKSBOX 16 Lİ | 1 | 10 | 555,60 |
| 001 027 000016 00 00 | W OTOMAT KUTUSU (S/A) MEKSBOX 16 Lİ | 1 | 10 | 555,60 |
| 001 027 100024 00 00 | W OTOMAT KUTUSU (S/Ü) MEKSBOX 24 LÜ | 1 | 5 | 695,90 |
| 001 027 000024 00 00 | W OTOMAT KUTUSU (S/A) MEKSBOX 24 LÜ | 1 | 5 | 695,90 |
| 001 027 100036 00 00 | W OTOMAT KUTUSU (S/Ü) MEKSBOX 36 Lİ | 1 | 5 | 896,70 |
| 001 027 000036 00 00 | W OTOMAT KUTUSU (S/A) MEKSBOX 36 Lİ | 1 | 5 | 896,70 |
| MEKSBOX W OTOMAT KUTULARI - ALEV YAYMAYAN | | | | |
| CE IP30 | | | | |
| 001 027 210001 00 00 | MÜH.W OTOMAT KUTUSU ALEV YAYMAYAN (S/Ü) 1 Lİ | 20 | 160 | 59,30 |
| 001 027 210002 00 00 | MÜH.W OTOMAT KUTUSU ALEV YAYMAYAN (S/Ü) 2 Lİ | 20 | 80 | 85,80 |
| 001 027 210004 00 00 | MÜH.W OTOMAT KUTUSU ALEV YAYMAYAN (S/Ü) 4 LÜ | 10 | 80 | 96,90 |
| 001 027 110002 00 00 | W OTOMAT KUTUSU (S/Ü) ALEV YAYMAYAN 2 Lİ | 1 | 30 | 337,00 |
| 001 027 010002 00 00 | W OTOMAT KUTUSU (S/A) ALEV YAYMAYAN 2 Lİ | 1 | 30 | 337,00 |
| 001 027 110004 00 00 | W OTOMAT KUTUSU (S/Ü) ALEV YAYMAYAN 4 LÜ | 1 | 20 | 370,40 |
| 001 027 010004 00 00 | W OTOMAT KUTUSU (S/A) ALEV YAYMAYAN 4 LÜ | 1 | 20 | 370,40 |
| 001 027 110006 00 00 | W OTOMAT KUTUSU (S/Ü) ALEV YAYMAYAN 6 Lİ | 1 | 20 | 425,90 |
| 001 027 010006 00 00 | W OTOMAT KUTUSU (S/A) ALEV YAYMAYAN 6 Lİ | 1 | 20 | 425,90 |
| 001 027 110009 00 00 | W OTOMAT KUTUSU (S/Ü) ALEV YAYMAYAN 9 LU | 1 | 20 | 537,00 |
| 001 027 010009 00 00 | W OTOMAT KUTUSU (S/A) ALEV YAYMAYAN 9 LU | 1 | 20 | 537,00 |
| 001 027 110012 00 00 | W OTOMAT KUTUSU (S/Ü) ALEV YAYMAYAN 12 Lİ | 1 | 10 | 722,20 |
| 001 027 010012 00 00 | W OTOMAT KUTUSU (S/A) ALEV YAYMAYAN 12 Lİ | 1 | 10 | 722,20 |
| 001 027 110016 00 00 | W OTOMAT KUTUSU (S/Ü) ALEV YAYMAYAN 16 Lİ | 1 | 10 | 833,30 |
| 001 027 010016 00 00 | W OTOMAT KUTUSU (S/A) ALEV YAYMAYAN 16 Lİ | 1 | 10 | 833,30 |
| 001 027 110024 00 00 | W OTOMAT KUTUSU (S/Ü) ALEV YAYMAYAN 24 LÜ | 1 | 5 | 1.129,60 |
| 001 027 010024 00 00 | W OTOMAT KUTUSU (S/A) ALEV YAYMAYAN 24 LÜ | 1 | 5 | 1.129,60 |
| 001 027 110036 00 00 | W OTOMAT KUTUSU (S/Ü) ALEV YAYMAYAN 36 Lİ | 1 | 5 | 1.592,60 |
| 001 027 010036 00 00 | W OTOMAT KUTUSU (S/A) ALEV YAYMAYAN 36 Lİ | 1 | 5 | 1.592,60 |

| Ürün Kodu | Ürün Adı | Ort. İç Çap | Ort. Dış Çap | Kutu Mt. | Koli Adet | Fiyat (₺) |
|---|--|-------------|--------------|----------|-----------|-----------|
| HAFİF SERİ PVC SİRALLER - ALEV YAYMAYAN (320N) | | | | | | |
| 001 020 010016 00 17 | 16 Ø A.YAYMAYAN SİRAL (HAFİF SERİ) | 11,4 | 15,85 | 100 mt. | 500 | 12,10 |
| 001 020 010020 00 17 | 20 Ø A.YAYMAYAN SİRAL (HAFİF SERİ) | 14,5 | 19,85 | 100 mt. | 500 | 16,50 |
| 001 020 010025 00 17 | 25 Ø A.YAYMAYAN SİRAL (HAFİF SERİ) | 18,7 | 24,8 | 50 mt. | 250 | 23,10 |
| 001 020 010032 00 17 | 32 Ø A.YAYMAYAN SİRAL (HAFİF SERİ) | 24,9 | 31,8 | 50 mt. | 250 | 30,00 |
| AĞIR SERİ PVC SİRALLER -ALEV YAYMAYAN (750N) | | | | | | |
| 001 020 000016 00 17 | 16 Ø A.YAYMAYAN SİRAL (AĞIR SERİ) | 11,2 | 15,85 | 100 mt. | 500 | 14,10 |
| 001 020 000020 00 17 | 20 Ø A.YAYMAYAN SİRAL (AĞIR SERİ) | 14,4 | 19,85 | 100 mt. | 500 | 18,70 |
| 001 020 000025 00 17 | 25 Ø A.YAYMAYAN SİRAL (AĞIR SERİ) | 18,1 | 24,8 | 50 mt. | 250 | 24,40 |
| 001 020 000032 00 17 | 32 Ø A.YAYMAYAN SİRAL (AĞIR SERİ) | 24,7 | 31,8 | 50 mt. | 250 | 30,90 |
| HAFİF SERİ PVC TELLİ SİRALLER - ALEV YAYMAYAN (320N) | | | | | | |
| 001 020 120016 00 17 | 16 Ø TELLİ A.YAYMAYAN (HAFİF SERİ) | 11,4 | 15,85 | 100 mt. | 500 | 14,90 |
| 001 020 120020 00 17 | 20 Ø TELLİ A.YAYMAYAN (HAFİF SERİ) | 14,5 | 19,85 | 100 mt. | 500 | 19,60 |
| 001 020 120025 00 17 | 25 Ø TELLİ A.YAYMAYAN (HAFİF SERİ) | 18,7 | 24,8 | 50 mt. | 250 | 26,20 |
| 001 020 120032 00 17 | 32 Ø TELLİ A.YAYMAYAN (HAFİF SERİ) | 24,9 | 31,8 | 50 mt. | 250 | 33,10 |
| AĞIR SERİ PVC TELLİ SİRALLER - ALEV YAYMAYAN (750N) | | | | | | |
| 001 020 100016 00 17 | 16 Ø TELLİ A.YAYMAYAN (AĞIR SERİ) | 11,2 | 15,85 | 100 mt. | 500 | 16,90 |
| 001 020 100020 00 17 | 20 Ø TELLİ A.YAYMAYAN (AĞIR SERİ) | 14,4 | 19,85 | 100 mt. | 500 | 21,60 |
| 001 020 100025 00 17 | 25 Ø TELLİ A.YAYMAYAN (AĞIR SERİ) | 18,1 | 24,8 | 50 mt. | 250 | 27,70 |
| 001 020 100032 00 17 | 32 Ø TELLİ A.YAYMAYAN (AĞIR SERİ) | 24,7 | 31,8 | 50 mt. | 250 | 34,00 |
| HALOJEN FREE SİRALLER -ALEV YAYAN (320N) | | | | | | |
| 001 020 140016 00 17 | 16 Ø HALOJEN FREE SPR. (ALEV YAYAN) | 11,2 | 15,7 | 100 mt. | 500 | 8,50 |
| 001 020 140020 00 17 | 20 Ø HALOJEN FREE SPR. (ALEV YAYAN) | 14,4 | 19,85 | 100 mt. | 500 | 10,30 |
| 001 020 140025 00 17 | 25 Ø HALOJEN FREE SPR. (ALEV YAYAN) | 19,1 | 24,7 | 50 mt. | 250 | 13,90 |
| 001 020 140032 00 17 | 32 Ø HALOJEN FREE SPR. (ALEV YAYAN) | 24,85 | 31,6 | 50 mt. | 250 | 17,90 |
| 001 020 140040 00 17 | 40 Ø HALOJEN FREE SPR. (ALEV YAYAN) | | | 25 mt. | 125 | 29,40 |
| 001 020 140050 00 17 | 50 Ø HALOJEN FREE SPR. (ALEV YAYAN) | | | 25 mt. | 125 | 39,30 |
| HALOJEN FREE SİRALLER -ALEV YAYAN (750N) | | | | | | |
| 001 020 740020 00 17 | 20 Ø HALOJEN FREE SPR. (ALEV YAYAN) | 14,4 | 19,85 | 100 mt. | 500 | 23,00 |
| 001 020 740025 00 17 | 25 Ø HALOJEN FREE SPR. (ALEV YAYAN) | 18,7 | 24,7 | 50 mt. | 250 | 32,40 |
| 001 020 740032 00 17 | 32 Ø HALOJEN FREE SPR. (ALEV YAYAN) | 24,2 | 31,6 | 50 mt. | 250 | 43,00 |
| HALOJEN FREE SİRALLER TELLİ - ALEV YAYAN (320N) | | | | | | |
| 001 020 141016 00 17 | 16 Ø H.FREE SİRAL(A.YAYAN)(TELLİ) | 11,2 | 15,7 | 100 mt. | 500 | 10,60 |
| 001 020 141020 00 17 | 20 Ø H.FREE SİRAL(A.YAYAN)(TELLİ) | 14,4 | 19,85 | 100 mt. | 500 | 12,30 |
| 001 020 141025 00 17 | 25 Ø H.FREE SİRAL(A.YAYAN)(TELLİ) | 19,1 | 24,7 | 50 mt. | 250 | 16,00 |
| 001 020 141032 00 17 | 32 Ø H.FREE SİRAL(A.YAYAN)(TELLİ) | 24,85 | 31,6 | 50 mt. | 250 | 19,90 |
| 001 020 141040 00 17 | 40 Ø H.FREE SİRAL(A.YAYAN)(TELLİ) | | | 25 mt. | 125 | 31,50 |
| HALOJEN FREE SİRALLER - ALEV YAYMAYAN (320N) | | | | | | |
| 001 020 150016 00 17 | 16 Ø HALOJEN FREE SPR.(A.YAYMAYAN) | 11,2 | 15,7 | 100 mt. | 500 | 11,70 |
| 001 020 150020 00 17 | 20 Ø HALOJEN FREE SPR.(A.YAYMAYAN) | 14,4 | 19,85 | 100 mt. | 500 | 14,60 |
| 001 020 150025 00 17 | 25 Ø HALOJEN FREE SPR.(A.YAYMAYAN) | 19,1 | 24,7 | 50 mt. | 250 | 20,10 |
| 001 020 150032 00 17 | 32 Ø HALOJEN FREE SPR.(A.YAYMAYAN) | 24,85 | 31,6 | 50 mt. | 250 | 25,50 |
| 001 020 150040 00 17 | 40 Ø HALOJEN FREE SPR.(A.YAYMAYAN) | | | 25 mt. | 125 | 42,90 |
| 001 020 150050 00 17 | 50 Ø HALOJEN FREE SPR.(A.YAYMAYAN) | | | 25 mt. | 125 | 55,90 |
| HALOJEN FREE SİRALLER - ALEV YAYMAYAN (750N) | | | | | | |
| 001 020 750020 00 17 | 20 Ø HALOJEN FREE SPR. (ALEV YAYMAYAN) | 14,4 | 19,85 | 100 mt. | 500 | 30,00 |
| 001 020 750025 00 17 | 25 Ø HALOJEN FREE SPR. (ALEV YAYMAYAN) | 18,7 | 24,7 | 50 mt. | 250 | 42,20 |
| 001 020 750032 00 17 | 32 Ø HALOJEN FREE SPR. (ALEV YAYMAYAN) | 24,2 | 31,6 | 50 mt. | 250 | 55,70 |
| HALOJEN FREE SİRALLER TELLİ - ALEV YAYMAYAN (320N) | | | | | | |
| 001 020 151016 00 17 | 16 Ø H.FREE SPR.(A.YAYMAYAN)(TELLİ) | 11,2 | 15,7 | 100 mt. | 500 | 14,90 |
| 001 020 151020 00 17 | 20 Ø H.FREE SPR.(A.YAYMAYAN)(TELLİ) | 14,4 | 19,85 | 100 mt. | 500 | 17,30 |
| 001 020 151025 00 17 | 25 Ø H.FREE SPR.(A.YAYMAYAN)(TELLİ) | 19,1 | 24,7 | 50 mt. | 250 | 22,50 |
| 001 020 151032 00 17 | 32 Ø H.FREE SPR.(A.YAYMAYAN)(TELLİ) | 24,85 | 31,6 | 50 mt. | 250 | 27,20 |
| 001 020 151040 00 17 | 40 Ø H.FREE SPR.(A.YAYMAYAN)(TELLİ) | | | 25 mt. | 125 | 43,50 |

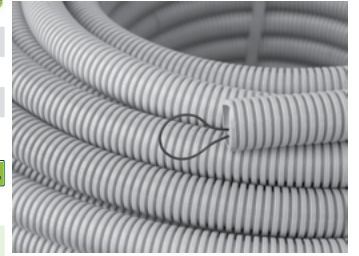



| Ürün Kodu | Ürün Adı | Ort. İç Çap | Ort. Dış Çap | Kutu Mt./Ad. | Koli Adet | Fiyat (₺) |
|--|-------------------------------------|-------------|--------------|--------------|-----------|-----------|
| MEKS SERİSİ PLASTİK SİRALLER - SİYAH | | | | | | |
| 001 020 400012 00 11 | 12 Ø PLASTİK SİRALLER (SİYAH) | 12,3 | 15,9 | 100 mt. | 1000 | 6,50 |
| 001 020 400014 00 11 | 14 Ø PLASTİK SİRALLER (SİYAH) | 15,25 | 18,75 | 100 mt. | 1000 | 6,60 |
| 001 020 400016 00 11 | 16 Ø PLASTİK SİRALLER (SİYAH) | 15,7 | 19 | 100 mt. | 1000 | 6,60 |
| 001 020 400018 00 11 | 18 Ø PLASTİK SİRALLER (SİYAH) | 19,6 | 24,03 | 100 mt. | 500 | 10,70 |
| 001 020 400020 00 11 | 20 Ø PLASTİK SİRALLER (SİYAH) | 19,6 | 24,03 | 100 mt. | 500 | 10,70 |
| 001 020 400026 00 11 | 26 Ø PLASTİK SİRALLER (SİYAH) | 26,15 | 30,75 | 50 mt. | 250 | 16,00 |
| 001 020 400032 00 11 | 32 Ø PLASTİK SİRALLER (SİYAH) | 29,1 | 34,3 | 50 mt. | 250 | 17,90 |
| 001 020 400040 00 11 | 40 Ø PLASTİK SİRALLER (SİYAH) | 36,2 | 42,2 | 25 mt. | 125 | 29,30 |
| 001 020 400050 00 11 | 50 Ø PLASTİK SİRALLER (SİYAH) | 48,5 | 54,5 | 25 mt. | 125 | 36,60 |
| MEKS SERİSİ PLASTİK SİRALLER - SİYAH - TELLİ | | | | | | |
| 001 020 410014 00 11 | 14 Ø PLASTİK SİRALLER (SİYAH) TELLİ | 15,25 | 18,75 | 100 mt. | 1000 | 9,00 |
| 001 020 410016 00 11 | 16 Ø PLASTİK SİRALLER (SİYAH) TELLİ | 15,7 | 19 | 100 mt. | 1000 | 9,00 |
| 001 020 410018 00 11 | 18 Ø PLASTİK SİRALLER (SİYAH) TELLİ | 19,6 | 24,03 | 100 mt. | 500 | 13,20 |
| 001 020 410020 00 11 | 20 Ø PLASTİK SİRALLER (SİYAH) TELLİ | 19,6 | 24,03 | 100 mt. | 500 | 13,20 |
| 001 020 410026 00 11 | 26 Ø PLASTİK SİRALLER (SİYAH) TELLİ | 26,15 | 30,75 | 50 mt. | 250 | 18,00 |
| 001 020 410032 00 11 | 32 Ø PLASTİK SİRALLER (SİYAH) TELLİ | 29,1 | 34,3 | 50 mt. | 250 | 19,90 |
| 001 020 410040 00 11 | 40 Ø PLASTİK SİRALLER (SİYAH) TELLİ | 36,2 | 42,2 | 25 mt. | 125 | 31,30 |
| PLASTİK SİRALLER - RENKLİ | | | | | | |
| 001 020 400014 00 XX | 14 Ø PLS. SİRAL (GRİ-BYZ-KIR-MAVİ) | 15,25 | 18,75 | 100 mt. | 1000 | 7,20 |
| 001 020 400016 00 XX | 16 Ø PLS. SİRAL (GRİ-BYZ-KIR-MAVİ) | 15,7 | 19 | 100 mt. | 1000 | 7,20 |
| 001 020 400018 00 XX | 18 Ø PLS. SİRAL (GRİ-BYZ-KIR-MAVİ) | 19,6 | 24,03 | 100 mt. | 500 | 11,50 |
| 001 020 400020 00 XX | 20 Ø PLS. SİRAL (GRİ-BYZ-KIR-MAVİ) | 19,6 | 24,03 | 100 mt. | 500 | 11,50 |
| 001 020 400026 00 XX | 26 Ø PLS. SİRAL (GRİ-BYZ-KIR-MAVİ) | 26,15 | 30,75 | 50 mt. | 250 | 17,10 |
| 001 020 400032 00 XX | 32 Ø PLS. SİRAL (GRİ-BYZ-KIR-MAVİ) | 29,1 | 34,3 | 50 mt. | 250 | 19,20 |
| 001 020 400040 00 XX | 40 Ø PLS. SİRAL (GRİ-BYZ-KIR-MAVİ) | 36,2 | 42,2 | 25 mt. | 125 | 31,40 |
| 001 020 400050 00 XX | 50 Ø PLS. SİRAL (GRİ-BYZ-KIR-MAVİ) | 48,5 | 54,5 | 25 mt. | 125 | 39,10 |
| 001 020 990016 00 17 | 16 mm SİRAL EK MUFU (GRİ) | | | | 200 ad. | 8,80 |
| 001 020 990020 00 17 | 20 mm SİRAL EK MUFU (GRİ) | | | | 200 ad. | 10,10 |
| 001 020 990025 00 17 | 25 mm SİRAL EK MUFU (GRİ) | | | | 100 ad. | 13,00 |
| 001 020 990032 00 17 | 32 mm SİRAL EK MUFU (GRİ) | | | | 200 ad. | 17,50 |
| KORUGE BORULAR (250N) CE | | | | | | |
| 096 045 150050 | 50 Ø KORUGE KANGAL BORU | 43 | 50 | 100 mt. | | 56,00 |
| 096 045 150060 | 63 Ø KORUGE KANGAL BORU | 54 | 63 | 100 mt. | | 72,00 |
| 096 045 150075 | 75 Ø KORUGE KANGAL BORU | 64 | 75 | 100 mt. | | 88,20 |
| 096 045 150100 | 100 Ø KORUGE BOY BORU (6 MT.) | 87 | 100 | 6 mt. | | 108,70 |
| 096 045 150115 | 115 Ø KORUGE BOY BORU (6 MT.) | 100 | 115 | 6 mt. | | 120,00 |
| 096 045 150004 | 50 Ø MANŞON | | | | 1 ad. | 16,90 |
| 096 045 150003 | 75 Ø MANŞON | | | | 1 ad. | 23,10 |
| 096 045 150002 | 100 Ø MANŞON | | | | 1 ad. | 29,20 |
| 096 045 150001 | 115 Ø MANŞON | | | | 1 ad. | 34,40 |
| LOGAR KUTUSU | | | | | | |
| 074 048 622020 | 20X20 LOGAR KUTUSU TAKIM | | | | 1 ad. | 235,30 |
| 074 048 623030 | 30X30 LOGAR KUTUSU TAKIM | | | | 1 ad. | 491,90 |
| 074 048 624040 | 40X40 LOGAR KUTUSU TAKIM | | | | 1 ad. | 1.155,00 |
| 074 048 625555 | 55X55 LOGAR KUTUSU TAKIM | | | | 1 ad. | 2.395,60 |



| Ürün Kodu | Ürün Adı | Ort. İç Çap | Ort. Dış Çap | Kutu Mt. | Koli Adet | Fiyat (₺) |
|-----------|----------|-------------|--------------|----------|-----------|-----------|
|-----------|----------|-------------|--------------|----------|-----------|-----------|

EKO SERİSİ ÇELİK SİRALLER

TS CE

| | | | | | | |
|----------------------|----------------------------------|----|------|--------|-----|--------|
| 001 054 150009 00 66 | 9 Ø EKO ÇELİK SİRALLER | 9 | 12,1 | 50 mt. | 200 | 20,90 |
| 001 054 150011 00 66 | 11 Ø EKO ÇELİK SİRALLER (3/8") | 11 | 14,1 | 50 mt. | 200 | 21,40 |
| 001 054 150014 00 66 | 14 Ø EKO ÇELİK SİRALLER (1/2") | 14 | 17,1 | 50 mt. | 200 | 25,70 |
| 001 054 150016 00 66 | 16 Ø EKO ÇELİK SİRALLER | 16 | 19,1 | 50 mt. | 200 | 28,30 |
| 001 054 150018 00 66 | 18 Ø EKO ÇELİK SİRALLER | 18 | 21,1 | 50 mt. | 200 | 32,40 |
| 001 054 150021 00 66 | 21 Ø EKO ÇELİK SİRALLER (3/4") | 21 | 24,1 | 50 mt. | 200 | 36,10 |
| 001 054 150026 00 66 | 26 Ø EKO ÇELİK SİRALLER (1") | 26 | 29,1 | 25 mt. | 100 | 49,30 |
| 001 054 150029 00 66 | 29 Ø EKO ÇELİK SİRALLER (1 1/4") | 29 | 32,1 | 25 mt. | 100 | 53,30 |
| 001 054 150032 00 66 | 32 Ø EKO ÇELİK SİRALLER | 32 | 35,1 | 25 mt. | 100 | 56,90 |
| 001 054 150037 00 66 | 37 Ø EKO ÇELİK SİRALLER (1 1/2") | 37 | 41,1 | 25 mt. | 100 | 74,80 |
| 001 054 150042 00 66 | 42 Ø EKO ÇELİK SİRALLER | 42 | 45,1 | 25 mt. | 100 | 87,20 |
| 001 054 150050 00 66 | 50 Ø EKO ÇELİK SİRALLER (2") | 50 | 53,1 | 25 mt. | 100 | 121,00 |
| 001 054 150063 00 66 | 63 Ø EKO ÇELİK SİRALLER | 63 | 66,1 | 15 mt. | 60 | 164,60 |

EKO SERİSİ ÇELİK SİRALLER - KILAVUZ TELLİ

TS CE

| | | | | | | |
|----------------------|----------------------------------|----|------|--------|-----|--------|
| 001 054 221011 00 66 | 11 Ø EKO Ç. SİRAL(TELLI)(3/8") | 11 | 14,1 | 50 mt. | 200 | 25,00 |
| 001 054 221014 00 66 | 14 Ø EKO Ç. SİRAL(TELLI)(1/2") | 14 | 17,1 | 50 mt. | 200 | 30,30 |
| 001 054 221016 00 66 | 16 Ø EKO Ç. SİRAL(TELLI) | 16 | 19,1 | 50 mt. | 200 | 32,10 |
| 001 054 221018 00 66 | 18 Ø EKO Ç. SİRAL(TELLI) | 18 | 21,1 | 50 mt. | 200 | 39,10 |
| 001 054 221021 00 66 | 21 Ø EKO Ç. SİRAL(TELLI) (3/4") | 21 | 24,1 | 50 mt. | 200 | 40,30 |
| 001 054 221026 00 66 | 26 Ø EKO Ç. SİRAL(TELLI)(1") | 26 | 29,1 | 25 mt. | 100 | 54,40 |
| 001 054 221029 00 66 | 29 Ø EKO Ç. SİRAL(TELLI)(1 1/4") | 29 | 32,1 | 25 mt. | 100 | 57,30 |
| 001 054 221032 00 66 | 32 Ø EKO Ç. SİRAL(TELLI) | 32 | 35,1 | 25 mt. | 100 | 65,60 |
| 001 054 221037 00 66 | 37 Ø EKO Ç. SİRAL(TELLI)(1 1/2") | 37 | 41,1 | 25 mt. | 100 | 79,60 |
| 001 054 221042 00 66 | 42 Ø EKO Ç. SİRAL(TELLI) | 42 | 45,1 | 25 mt. | 100 | 91,80 |
| 001 054 221050 00 66 | 50 Ø EKO Ç. SİRAL(TELLI) (2") | 50 | 53,1 | 25 mt. | 100 | 125,70 |
| 001 054 221063 00 66 | 63 Ø EKO ÇELİK SİRALLER | 63 | 66,1 | 15 mt. | 60 | 157,60 |

EKO SERİSİ İZOLELİ ÇELİK SİRALLER

TS CE

| | | | | | | |
|----------------------|------------------------------------|----|------|--------|--|--------|
| 001 054 160009 00 11 | 9 Ø EKO İZOLELİ Ç. SİRAL | 9 | 13,2 | 50 mt. | | 26,30 |
| 001 054 160011 00 11 | 11 Ø EKO İZOLELİ Ç. SİRAL(3/8") | 11 | 15,2 | 50 mt. | | 28,30 |
| 001 054 160014 00 11 | 14 Ø EKO İZOLELİ Ç. SİRAL(1/2") | 14 | 18,4 | 50 mt. | | 33,70 |
| 001 054 160016 00 11 | 16 Ø EKO İZOLELİ Ç. SİRAL | 16 | 20,4 | 50 mt. | | 37,40 |
| 001 054 160018 00 11 | 18 Ø EKO İZOLELİ Ç. SİRAL | 18 | 22,4 | 50 mt. | | 43,20 |
| 001 054 160021 00 11 | 21 Ø EKO İZOLELİ Ç. SİRAL (3/4") | 21 | 25,4 | 50 mt. | | 51,30 |
| 001 054 160026 00 11 | 26 Ø EKO İZOLELİ Ç. SİRAL(1") | 26 | 30,4 | 25 mt. | | 63,00 |
| 001 054 160029 00 11 | 29 Ø EKO İZOLELİ Ç. SİRAL(1 1/4") | 29 | 33,4 | 25 mt. | | 68,70 |
| 001 054 160032 00 11 | 32 Ø EKO İZOLELİ Ç. SİRAL | 32 | 36,4 | 25 mt. | | 76,50 |
| 001 054 160037 00 11 | 37 Ø EKO İZOLELİ Ç. SİRAL (1 1/2") | 37 | 42,4 | 25 mt. | | 98,00 |
| 001 054 160042 00 11 | 42 Ø EKO İZOLELİ Ç. SİRAL | 42 | 46,4 | 25 mt. | | 118,80 |
| 001 054 160050 00 11 | 50 Ø EKO İZOLELİ Ç. SİRAL(2") | 50 | 54,4 | 25 mt. | | 159,20 |
| 001 054 160063 00 11 | 63 Ø EKO İZOLELİ Ç. SİRAL | 63 | 66,1 | 15 mt. | | 204,90 |

EKO SERİSİ İZOLELİ ÇELİK SİRALLER - KILAVUZ TELLİ

TS CE

| | | | | | | |
|----------------------|-------------------------------------|----|------|--------|--|--------|
| 001 054 231011 00 11 | 11 Ø EKO İZO.Ç. SPR.(TELLİ)(3/8") | 11 | 15,2 | 50 mt. | | 31,90 |
| 001 054 231014 00 11 | 14 Ø EKO İZO.Ç. SPR.(TELLİ)(1/2") | 14 | 18,4 | 50 mt. | | 38,70 |
| 001 054 231016 00 11 | 16 Ø EKO İZO.Ç. SPR.(TELLİ) | 16 | 20,4 | 50 mt. | | 41,20 |
| 001 054 231018 00 11 | 18 Ø EKO İZO.Ç. SPR.(TELLİ) | 18 | 22,4 | 50 mt. | | 46,40 |
| 001 054 231021 00 11 | 21 Ø EKO İZO.Ç. SPR.(TELLİ) (3/4") | 21 | 25,4 | 50 mt. | | 54,70 |
| 001 054 231026 00 11 | 26 Ø EKO İZO.Ç. SPR.(TELLİ)(1") | 26 | 30,4 | 25 mt. | | 67,10 |
| 001 054 231029 00 11 | 29 Ø EKO İZO.Ç. SPR.(TELLİ)(1 1/4") | 29 | 33,4 | 25 mt. | | 72,00 |
| 001 054 231032 00 11 | 32 Ø EKO İZO.Ç. SPR.(TELLİ) | 32 | 36,4 | 25 mt. | | 84,70 |
| 001 054 231037 00 11 | 37 Ø EKO İZO.Ç. SPR.(TELLİ)(1 1/2") | 37 | 42,4 | 25 mt. | | 104,30 |
| 001 054 231042 00 11 | 42 Ø EKO İZO.Ç. SPR.(TELLİ) | 42 | 46,4 | 25 mt. | | 119,10 |
| 001 054 231050 00 11 | 50 Ø EKO İZO.Ç. SPR.(TELLİ) (2") | 50 | 54,4 | 25 mt. | | 166,90 |
| 001 054 231063 00 11 | 63 Ø EKO İZOLELİ Ç. SİRAL | 63 | 66,1 | 15 mt. | | 213,84 |

MEKS SERİSİ ÇELİK SİRALLER

| | | | | | | | |
|----------------------|------------------------------|----|----|------|--------|-----|--------|
| 001 054 120009 00 66 | 9 Ø ÇELİK SİRALLER | CE | 9 | 12,1 | 50 mt. | 200 | 22,30 |
| 001 054 120011 00 66 | 11 Ø ÇELİK SİRALLER(3/8") | CE | 11 | 14,1 | 50 mt. | 200 | 23,20 |
| 001 054 120014 00 66 | 14 Ø ÇELİK SİRALLER(1/2") | CE | 14 | 17,1 | 50 mt. | 200 | 28,00 |
| 001 054 120016 00 66 | 16 Ø ÇELİK SİRALLER | CE | 16 | 19,1 | 50 mt. | 200 | 30,70 |
| 001 054 120018 00 66 | 18 Ø ÇELİK SİRALLER | CE | 18 | 21,1 | 50 mt. | 200 | 35,20 |
| 001 054 120021 00 66 | 21 Ø ÇELİK SİRALLER (3/4") | | 21 | 24,1 | 50 mt. | 200 | 41,00 |
| 001 054 120026 00 66 | 26 Ø ÇELİK SİRALLER(1") | CE | 26 | 29,1 | 25 mt. | 100 | 53,70 |
| 001 054 120029 00 66 | 29 Ø ÇELİK SİRALLER(1 1/4") | CE | 29 | 32,1 | 25 mt. | 100 | 57,60 |
| 001 054 120032 00 66 | 32 Ø ÇELİK SİRALLER | | 32 | 35,1 | 25 mt. | 100 | 63,90 |
| 001 054 120037 00 66 | 37 Ø ÇELİK SİRALLER (1 1/2") | CE | 37 | 41,1 | 25 mt. | 100 | 80,40 |
| 001 054 120042 00 66 | 42 Ø ÇELİK SİRALLER | CE | 42 | 45,1 | 25 mt. | 100 | 91,40 |
| 001 054 120050 00 66 | 50 Ø ÇELİK SİRALLER(2") | CE | 50 | 53,1 | 25 mt. | 100 | 135,20 |
| 001 054 120063 00 66 | 63 Ø ÇELİK SİRALLER | | 63 | 66,1 | 15 mt. | 60 | 183,50 |

MEKS SERİSİ ÇELİK SİRALLER (KILAVUZ TELLİ)

| | | | | | | | |
|----------------------|------------------------------|--|----|------|--------|-----|--------|
| 001 054 121011 00 66 | 11 Ø Ç. SİRAL(TELLI)(3/8") | | 11 | 14,1 | 50 mt. | 200 | 27,20 |
| 001 054 121014 00 66 | 14 Ø Ç. SİRAL(TELLI)(1/2") | | 14 | 17,1 | 50 mt. | 200 | 33,00 |
| 001 054 121016 00 66 | 16 Ø Ç. SİRAL(TELLI) | | 16 | 19,1 | 50 mt. | 200 | 34,90 |
| 001 054 121018 00 66 | 18 Ø Ç. SİRAL(TELLI) | | 18 | 21,1 | 50 mt. | 200 | 42,50 |
| 001 054 121021 00 66 | 21 Ø Ç. SİRAL(TELLI) (3/4") | | 21 | 24,1 | 50 mt. | 200 | 43,70 |
| 001 054 121026 00 66 | 26 Ø Ç. SİRAL(TELLI)(1") | | 26 | 29,1 | 25 mt. | 100 | 58,20 |
| 001 054 121029 00 66 | 29 Ø Ç. SİRAL(TELLI)(1 1/4") | | 29 | 32,1 | 25 mt. | 100 | 61,40 |
| 001 054 121032 00 66 | 32 Ø Ç. SİRAL(TELLI) | | 32 | 35,1 | 25 mt. | 100 | 73,40 |
| 001 054 121037 00 66 | 37 Ø Ç. SİRAL(TELLI)(1 1/2") | | 37 | 41,1 | 25 mt. | 100 | 85,40 |
| 001 054 121042 00 66 | 42 Ø Ç. SİRAL(TELLI) | | 42 | 45,1 | 25 mt. | 100 | 104,60 |
| 001 054 121050 00 66 | 50 Ø Ç. SİRAL(TELLI) (2") | | 50 | 53,1 | 25 mt. | 100 | 142,70 |
| 001 054 121063 00 66 | 63 Ø Ç. SİRAL(TELLI) (2") | | 63 | 66,1 | 15 mt. | 60 | 193,90 |



| Ürün Kodu | Ürün Adı | Ort. İç Çap | Ort. Dış Çap | Kutu Mt./Ad. | Koli Adet | Fiyat (₺) |
|--|--------------------------------|-------------|--------------|--------------|-----------|-----------|
| MEKS SERİSİ İZOLELİ ÇELİK SİRALER | | | | | | |
| 001 054 130009 00 11 | 9 Ø İZOLELİ Ç. SİRAL | 9 | 13,2 | 50 mt. | | 30,10 |
| 001 054 130011 00 11 | 11 Ø İZOLELİ Ç. SİRAL(3/8") | 11 | 15,2 | 50 mt. | | 30,80 |
| 001 054 130014 00 11 | 14 Ø İZOLELİ Ç. SİRAL(1/2") | 14 | 18,4 | 50 mt. | | 35,40 |
| 001 054 130016 00 11 | 16 Ø İZOLELİ Ç. SİRAL | 16 | 20,4 | 50 mt. | | 40,60 |
| 001 054 130018 00 11 | 18 Ø İZOLELİ Ç. SİRAL | 18 | 22,4 | 50 mt. | | 46,90 |
| 001 054 130026 00 11 | 26 Ø İZOLELİ Ç. SİRAL(1") | 26 | 30,4 | 25 mt. | | 67,40 |
| 001 054 130029 00 11 | 29 Ø İZOLELİ Ç. SİRAL(1 1/4") | 29 | 33,4 | 25 mt. | | 76,90 |
| 001 054 130032 00 11 | 32 Ø İZOLELİ Ç. SİRAL | 32 | 36,4 | 25 mt. | | 89,10 |
| 001 054 130037 00 11 | 37 Ø İZOLELİ Ç. SİRAL (1 1/2") | 37 | 42,4 | 25 mt. | | 106,10 |
| 001 054 130042 00 11 | 42 Ø İZOLELİ Ç. SİRAL | 42 | 46,4 | 25 mt. | | 132,70 |
| 001 054 130050 00 11 | 50 Ø İZOLELİ Ç. SİRAL(2") | 50 | 54,4 | 25 mt. | | 177,80 |
| 001 054 130063 00 11 | 63 Ø İZOLELİ ÇELİK SİRAL | 63 | 67,2 | 15 mt. | | 228,50 |



| | | | | | | |
|--|---------------------------------|----|------|--------|--|--------|
| MEKS SERİSİ İZOLELİ ÇELİK SİRALER - KILAVUZ TELLİ | | | | | | |
| 001 054 140011 00 11 | 11 Ø İZO.Ç. SPR.(TELLİ)(3/8") | 11 | 15,2 | 50 mt. | | 34,70 |
| 001 054 140014 00 11 | 14 Ø İZO.Ç. SPR.(TELLİ)(1/2") | 14 | 18,4 | 50 mt. | | 42,00 |
| 001 054 140016 00 11 | 16 Ø İZO.Ç. SPR. (TELLİ) | 16 | 20,4 | 50 mt. | | 44,20 |
| 001 054 140018 00 11 | 18 Ø İZO.Ç. SPR.(TELLİ) | 18 | 22,4 | 50 mt. | | 48,50 |
| 001 054 140026 00 11 | 26 Ø İZO.Ç. SPR.(TELLİ)(1") | 26 | 30,4 | 25 mt. | | 71,90 |
| 001 054 140029 00 11 | 29 Ø İZO.Ç. SPR.(TELLİ)(1 1/4") | 29 | 33,4 | 25 mt. | | 81,00 |
| 001 054 140032 00 11 | 32 Ø İZO.Ç. SPR.(TELLİ) | 32 | 36,4 | 25 mt. | | 94,90 |
| 001 054 140037 00 11 | 37 Ø İZO.Ç. SPR.(TELLİ)(1 1/2") | 37 | 42,4 | 25 mt. | | 112,10 |
| 001 054 140042 00 11 | 42 Ø İZO.Ç. SPR.(TELLİ) | 42 | 46,4 | 25 mt. | | 140,70 |
| 001 054 140050 00 11 | 50 Ø İZO.Ç. SPR.(TELLİ) (2") | 50 | 54,4 | 25 mt. | | 185,60 |
| 001 054 140063 00 11 | 63 Ø İZO.Ç. SPR.(TELLİ) | 63 | 67,2 | 15 mt. | | 237,60 |



| | | | | | | |
|---------------------------------------|-----------------------------|--|--|-------|--|---------|
| NİKEL KAPLI ÇELİK SİRAL RAKORU | | | | | | |
| 012 097 030009 | CLK- 9 ÇELİK SİRAL RAKORU | | | 1 ad. | | 4,40 € |
| 012 097 030011 | CLK-11 ÇELİK SİRAL RAKORU | | | 1 ad. | | 5,20 € |
| 012 097 030014 | CLK-13,5 ÇELİK SİRAL RAKORU | | | 1 ad. | | 6,10 € |
| 012 097 030016 | CLK-16 ÇELİK SİRAL RAKORU | | | 1 ad. | | 7,00 € |
| 012 097 030018 | CLK-18 ÇELİK SİRAL RAKORU | | | 1 ad. | | 7,60 € |
| 012 097 030026 | CLK-26 ÇELİK SİRAL RAKORU | | | 1 ad. | | 12,00 € |



| | | | | | | |
|-----------------------------------|---------------------|--|--|-------|--|---------|
| SÜPER ETANJ METAL RAKORLAR | | | | | | |
| 057 097 100007 | PG-7 METAL RAKOR | | | 1 ad. | | 2,10 € |
| 057 097 100009 | PG-9 METAL RAKOR | | | 1 ad. | | 2,60 € |
| 057 097 100011 | PG-11 METAL RAKOR | | | 1 ad. | | 3,47 € |
| 057 097 100135 | PG-13,5 METAL RAKOR | | | 1 ad. | | 3,68 € |
| 057 097 100016 | PG-16 METAL RAKOR | | | 1 ad. | | 4,58 € |
| 057 097 100021 | PG-21 METAL RAKOR | | | 1 ad. | | 7,79 € |
| 057 097 100029 | PG-29 METAL RAKOR | | | 1 ad. | | 19,64 € |
| 057 097 100036 | PG-36 METAL RAKOR | | | 1 ad. | | 28,66 € |
| 057 097 100042 | PG-42 METAL RAKOR | | | 1 ad. | | 40,51 € |
| 057 097 100048 | PG-48 METAL RAKOR | | | 1 ad. | | 48,64 € |



| Ürün Kodu | Ürün Adı | Kutu Mt. | Koli Adet | Fiyat (₺) | |
|--|--|----------|-----------|-----------|----------|
| PVC ALEV YAYMAYAN BOY BORULAR | | | | | |
| 001 045 120014 30 17 | 14 Ø PVC ALEV YAYMAYAN BOY BORU (BOY: 3 MT) | ☐ ☐ | 102 mt. | 17,70 | |
| 001 045 120016 30 17 | 16 Ø PVC ALEV YAYMAYAN BOY BORU (BOY: 3 MT) | ☐ ☐ ☐ | 102 mt. | 21,00 | |
| 001 045 120018 30 17 | 18 Ø PVC ALEV YAYMAYAN BOY BORU (BOY: 3 MT) | ☐ ☐ | 102 mt. | 23,20 | |
| 001 045 120020 30 17 | 20 Ø PVC ALEV YAYMAYAN BOY BORU (BOY: 3 MT) | ☐ ☐ ☐ | 102 mt. | 30,30 | |
| 001 045 120025 30 17 | 25 Ø PVC ALEV YAYMAYAN BOY BORU (BOY: 3 MT) | ☐ ☐ ☐ | 51 mt. | 41,10 | |
| 001 045 120032 30 17 | 32 Ø PVC ALEV YAYMAYAN BOY BORU (BOY: 3 MT) | ☐ ☐ ☐ | 30 mt. | 67,50 | |
| 001 045 120040 30 17 | 40 Ø PVC ALEV YAYMAYAN BOY BORU (BOY: 3 MT) | ☐ ☐ ☐ | 30 mt. | 131,30 | |
| PVC ALEV YAYMAYAN KENDİNDEN MUFLU BOY BORULAR | | | | | |
| 001 045 110014 30 17 | 14 Ø PVC ALEV YAYMAYAN KENDİNDEN MUFLU BOY BORU (3M) | ☐ ☐ | 102 mt. | 20,70 | |
| 001 045 110016 30 17 | 16 Ø PVC ALEV YAYMAYAN KENDİNDEN MUFLU BOY BORU (3M) | ☐ ☐ ☐ | 102 mt. | 24,60 | |
| 001 045 110018 30 17 | 18 Ø PVC ALEV YAYMAYAN KENDİNDEN MUFLU BOY BORU (3M) | ☐ ☐ | 102 mt. | 27,20 | |
| 001 045 110020 30 17 | 20 Ø PVC ALEV YAYMAYAN KENDİNDEN MUFLU BOY BORU (3M) | ☐ ☐ ☐ | 102 mt. | 35,50 | |
| 001 045 110025 30 17 | 25 Ø PVC ALEV YAYMAYAN KENDİNDEN MUFLU BOY BORU (3M) | ☐ ☐ ☐ | 51 mt. | 48,10 | |
| 001 045 110032 30 17 | 32 Ø PVC ALEV YAYMAYAN KENDİNDEN MUFLU BOY BORU (3M) | ☐ ☐ ☐ | 30 mt. | 79,00 | |
| 001 045 110040 30 17 | 40 Ø PVC ALEV YAYMAYAN KENDİNDEN MUFLU BOY BORU (3M) | ☐ ☐ ☐ | 30 mt. | 153,60 | |
| DIRSEK VE MUFLAR - ALEV YAYMAYAN | | | | | |
| 001 051 010014 00 17 | 14 Ø DIRSEK ALEV YAYMAYAN | ☐ ☐ | 100 ad. | 700 | 10,30 |
| 001 051 010016 00 17 | 16 Ø DIRSEK ALEV YAYMAYAN | ☐ ☐ ☐ | 100 ad. | 600 | 10,50 |
| 001 051 010018 00 17 | 18 Ø DIRSEK ALEV YAYMAYAN | ☐ ☐ | 100 ad. | 400 | 10,70 |
| 001 051 010020 00 17 | 20 Ø DIRSEK ALEV YAYMAYAN | ☐ ☐ ☐ | 100 ad. | 300 | 11,60 |
| 001 051 010025 00 17 | 25 Ø DIRSEK ALEV YAYMAYAN | ☐ ☐ ☐ | 50 ad. | 150 | 22,80 |
| 001 051 010032 00 17 | 32 Ø DIRSEK ALEV YAYMAYAN | ☐ ☐ ☐ | 50 ad. | 100 | 41,70 |
| 001 051 030014 00 17 | 14-16 Ø MUF ALEV YAYMAYAN | ☐ ☐ ☐ | 100 ad. | 700 | 5,40 |
| 001 051 030018 00 17 | 18-20 Ø MUF ALEV YAYMAYAN | ☐ ☐ ☐ | 100 ad. | 500 | 5,70 |
| 001 051 030025 00 17 | 25 Ø MUF ALEV YAYMAYAN | ☐ ☐ ☐ | 50 ad. | 300 | 19,70 |
| 001 051 030032 00 17 | 32 Ø MUF ALEV YAYMAYAN | ☐ ☐ ☐ | 50 ad. | 200 | 22,20 |
| GEÇMELİ TİP ANTİGRON BORU KROŞELERİ | | | | | |
| 001 048 010016 00 17 | 16 Ø ANTİGRON BORU KROŞESİ (GEÇMELİ) | | 100 ad. | 2000 | 2,53 |
| 001 048 010018 00 17 | 18 Ø ANTİGRON BORU KROŞESİ (GEÇMELİ) | | 100 ad. | 3000 | 4,20 |
| 001 048 010020 00 17 | 20 Ø ANTİGRON BORU KROŞESİ (GEÇMELİ) | | 100 ad.. | 4500 | 4,30 |
| 001 048 010025 00 17 | 25 Ø ANTİGRON BORU KROŞESİ (GEÇMELİ) | | 100 ad. | 1000 | 4,40 |
| 001 048 010032 00 17 | 32 Ø ANTİGRON BORU KROŞESİ (GEÇMELİ) | | 100 ad. | 800 | 4,80 |
| 001 048 010040 00 17 | 40 Ø ANTİGRON BORU KROŞESİ (GEÇMELİ) | | 50 ad. | 750 | 8,00 |
| 074 048 050016 | 16 Ø ANTİGRON BORU KROŞESİ KAPAKLI(GEÇMELİ) | | 100 ad. | 4000 | 3,60 |
| 074 048 050017 | 20 Ø ANTİGRON BORU KROŞESİ KAPAKLI(GEÇMELİ) | | 100 ad. | 3500 | 4,70 |
| 074 048 050025 | 25 Ø ANTİGRON BORU KROŞESİ KAPAKLI(GEÇMELİ) | | 100 ad. | 3000 | 5,50 |
| 074 048 050032 | 32 Ø ANTİGRON BORU KROŞESİ KAPAKLI(GEÇMELİ) | | 50 ad. | 1500 | 6,10 |
| FİBER SUSTALAR | | | | | |
| 999 999 000779 | FİBER KILAVUZ 11MM (100-120-150-200M) | | 1 mt. | | 178,00 |
| 999 999 000780 | FİBER KILAVUZ MAKARASI | | 1 ad. | | 7.892,40 |
| PLASTİK SUSTALAR - KILAVUZ TELLİ | | | | | |
| 049 019 400010 | 10 MT. KILAVUZ TELLİ PLASTİK SUSTA | | 1 ad. | 25 | 164,00 |
| 049 019 400015 | 15 MT. KILAVUZ TELLİ PLASTİK SUSTA | | 1 ad. | 20 | 246,00 |
| 049 019 400020 | 20 MT. KILAVUZ TELLİ PLASTİK SUSTA | | 1 ad. | 15 | 328,00 |
| 049 019 400025 | 25 MT. KILAVUZ TELLİ PLASTİK SUSTA | | 1 ad. | 15 | 410,00 |
| ÇELİK SUSTA ve ZİNCİR | | | | | |
| 001 019 000010 00 00 | SUSTA (1.KALİTE) (10M) | | 40 ad. | 40 | 269,00 |
| 001 019 000015 00 00 | SUSTA (1.KALİTE) (15M) | | 30 ad. | 30 | 388,30 |
| 001 019 000020 00 00 | SUSTA (1.KALİTE) (20M) | | 20 ad. | 20 | 506,10 |
| 001 019 000025 00 00 | SUSTA (1.KALİTE) (25M) | | 15 ad. | 15 | 624,90 |
| 001 019 100010 00 00 | TAKVİYELİ SUSTA(1.KALİTE)(10M) | | 40 ad. | 40 | 290,40 |
| 001 019 100015 00 00 | TAKVİYELİ SUSTA(1.KALİTE)(15M) | | 30 ad. | 30 | 406,70 |
| 001 019 100020 00 00 | TAKVİYELİ SUSTA(1.KALİTE)(20M) | | 20 ad. | 20 | 541,50 |
| 001 019 100025 00 00 | TAKVİYELİ SUSTA(1.KALİTE)(25M) | | 15 ad. | 15 | 666,70 |
| 001 018 000001 00 00 | FLORESAN ZİNCİRİ | | 100 mt. | 500 | 20,40 |



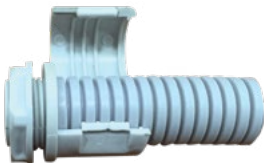

| Ürün Kodu | Ürün Adı | Kutu Mt./Ad. | Koli Adet | Fiyat (₺) |
|--|--|--------------|-----------|-----------|
| BOY BORULAR - HALOJEN FREE - ALEV YAYMAYAN - FLARET - 320N TSF CE | | | | |
| 001 045 500016 30 17 | 16 Ø HALOJEN FREE A.YAYMAYAN BORU(3M)(320N) | 102 mt. | | 73,00 |
| 001 045 500020 30 17 | 20 Ø HALOJEN FREE A.YAYMAYAN BORU(3M)(320N) | 102 mt. | | 89,10 |
| 001 045 500025 30 17 | 25 Ø HALOJEN FREE A.YAYMAYAN BORU(3M)(320N) | 102 mt. | | 123,60 |
| 001 045 500032 30 17 | 32 Ø HALOJEN FREE A.YAYMAYAN BORU(3M)(320N) | 102 mt. | | 174,90 |
| 001 045 500040 30 17 | 40 Ø HALOJEN FREE A.YAYMAYAN BORU(3M)(320N) | 51 mt. | | 250,40 |
| 001 045 500050 30 17 | 50 Ø HALOJEN FREE A.YAYMAYAN BORU(3M)(320N) | 30 mt. | | 410,90 |
| BOY BORULAR - HALOJEN FREE - ALEV YAYMAYAN - FLARET - 750N TSF CE | | | | |
| 001 045 510016 30 17 | 16 Ø HALOJEN FREE A.YAYMAYAN BORU(3M)(750N) | 102 mt. | | 77,00 |
| 001 045 510020 30 17 | 20 Ø HALOJEN FREE A.YAYMAYAN BORU(3M)(750N) | 102 mt. | | 97,10 |
| 001 045 510025 30 17 | 25 Ø HALOJEN FREE A.YAYMAYAN BORU(3M)(750N) | 102 mt. | | 131,60 |
| 001 045 510032 30 17 | 32 Ø HALOJEN FREE A.YAYMAYAN BORU(3M)(750N) | 102 mt. | | 183,00 |
| 001 045 510040 30 17 | 40 Ø HALOJEN FREE A.YAYMAYAN BORU(3M)(750N) | 51 mt. | | 258,40 |
| 001 045 510050 30 17 | 50 Ø HALOJEN FREE A.YAYMAYAN BORU(3M)(750N) | 30 mt. | | 508,00 |
| BOY BORULAR - HALOJEN FREE - ALEV YAYMAYAN - FLARET - 1250N TSF CE | | | | |
| 001 045 520016 30 17 | 16 Ø HALOJEN FREE A.YAYMAYAN BORU(3M)(1250N) | 102 mt. | | 83,50 |
| 001 045 520020 30 17 | 20 Ø HALOJEN FREE A.YAYMAYAN BORU(3M)(1250N) | 102 mt. | | 103,50 |
| 001 045 520025 30 17 | 25 Ø HALOJEN FREE A.YAYMAYAN BORU(3M)(1250N) | 102 mt. | | 142,80 |
| 001 045 520032 30 17 | 32 Ø HALOJEN FREE A.YAYMAYAN BORU(3M)(1250N) | 102 mt. | | 207,50 |
| 001 045 520040 30 17 | 40 Ø HALOJEN FREE A.YAYMAYAN BORU(3M)(1250N) | 51 mt. | | 266,40 |
| 001 045 520050 30 17 | 50 Ø HALOJEN FREE A.YAYMAYAN BORU(3M)(1250N) | 30 mt. | | 522,40 |
| BORU - SİRAL EK MUF - ALEV YAYMAYAN | | | | |
| 999 999 777616 | 16 LİK BORU-SİRAL EK MUFU A.YAYMAYAN | 100 ad. | 4000 | 17,00 |
| 999 999 777620 | 20 LİK BORU-SİRAL EK MUFU A.YAYMAYAN | 100 ad. | 2000 | 17,50 |
| 999 999 777625 | 25 LİK BORU-SİRAL EK MUFU A.YAYMAYAN | 100 ad. | 2000 | 24,30 |
| 999 999 777632 | 32 LİK BORU-SİRAL EK MUFU A.YAYMAYAN | 100 ad. | 1000 | 30,40 |
| DÜZ BORU T DİRSEK - ALEV YAYMAYAN | | | | |
| 999 999 999888 | 16 LİK DÜZ BORU T DİRSEK A.YAYMAYAN | 100 ad. | 1500 | 37,70 |
| 999 999 999889 | 20 LİK DÜZ BORU T DİRSEK A.YAYMAYAN | 100 ad. | 1000 | 38,10 |
| 999 999 999890 | 25 LİK DÜZ BORU T DİRSEK A.YAYMAYAN | 50 ad. | 800 | 53,80 |
| 999 999 999891 | 32 LİK DÜZ BORU T DİRSEK A.YAYMAYAN | 25 ad. | 500 | 70,00 |
| DÜZ BORU RAKORU - ALEV YAYMAYAN | | | | |
| 999 999 998816 | Ø16 DÜZ BORU REKORU A. YAYMAYAN | 100 ad. | 4000 | 36,50 |
| 999 999 998820 | Ø20 DÜZ BORU REKORU A. YAYMAYAN | 100 ad. | 2500 | 40,50 |
| 999 999 998825 | Ø25 DÜZ BORU REKORU A. YAYMAYAN | 100 ad. | 2000 | 46,40 |
| 999 999 998832 | Ø32 DÜZ BORU REKORU A. YAYMAYAN | 100 ad. | 1000 | 61,80 |
| ANTİGRON BORU KROŞESİ (GEÇMELİ) - ALEV YAYMAYAN | | | | |
| 074 048 060016 | Ø16 ANT. BORU KRO. (GEÇ. TİP) KAPAKLI A.YAYMAYAN | 100 ad. | 4000 | 7,30 |
| 074 048 060020 | Ø20 ANT. BORU KRO. (GEÇ. TİP) KAPAKLI A.YAYMAYAN | 100 ad. | 3500 | 8,30 |
| 074 048 060025 | Ø25 ANT. BORU KRO. (GEÇ. TİP) KAPAKLI A.YAYMAYAN | 100 ad. | 3000 | 10,20 |
| 074 048 060032 | Ø32 ANT. BORU KRO. (GEÇ. TİP) KAPAKLI A.YAYMAYAN | 100 ad. | 2000 | 12,50 |
| SİRAL RAKORU - ALEV YAYMAYAN | | | | |
| 999 999 777516 | Ø16 KAPAKLI SİRAL REKORU A.YAYMAYAN | 100 ad. | 4000 | 35,10 |
| 999 999 777520 | Ø20 KAPAKLI SİRAL REKORU A.YAYMAYAN | 100 ad. | 3000 | 42,30 |
| 999 999 777525 | Ø25 KAPAKLI SİRAL REKORU A.YAYMAYAN | 100 ad. | 1800 | 48,40 |
| 999 999 777532 | Ø32 KAPAKLI SİRAL REKORU A.YAYMAYAN | 100 ad. | 1000 | 61,80 |

PVC BORU AKSESUARLARI - KAPAKSIZ

| Ürün Kodu | Ürün Adı | Kutu/Koli Adedi | Fiyat (\$) |
|----------------|--------------------|-----------------|------------|
| 999 998 000001 | PVC BUAT 20 (1'Lİ) | 400 | 0,75 \$ |
| 999 998 000002 | PVC BUAT 20 (2'Lİ) | 400 | 0,75 \$ |
| 999 998 000003 | PVC BUAT 20 (3'LÜ) | 400 | 0,80 \$ |
| 999 998 000004 | PVC BUAT 20 (4'LÜ) | 400 | 0,80 \$ |
| 999 998 000005 | PVC BUAT 25 (1'Lİ) | 300 | 1,03 \$ |
| 999 998 000006 | PVC BUAT 25 (2'Lİ) | 300 | 1,03 \$ |
| 999 998 000007 | PVC BUAT 25 (3'LÜ) | 300 | 1,08 \$ |
| 999 998 000008 | PVC BUAT 25 (4'LÜ) | 300 | 1,08 \$ |



| Ürün Kodu | Ürün Adı | Kutu/Koli Adedi | Fiyat (\$) |
|----------------|---------------------------|-----------------|------------|
| 999 998 000009 | PVC İNGİLİZ TİP KASA 1'Lİ | 200 | 0,80 \$ |
| 999 998 000010 | PVC İNGİLİZ TİP KASA 2'Lİ | 100 | 1,50 \$ |



| Ürün Kodu | Ürün Adı | Kutu/Koli Adedi | Fiyat (€) |
|----------------|---------------------|-----------------|-----------|
| 999 999 777094 | Q16 BORU BÜKME YAYI | 1 | 36,31 € |
| 999 999 777093 | Q20 BORU BÜKME YAYI | 1 | 46,85 € |
| 999 999 777099 | Q25 BORU BÜKME YAYI | 1 | 58,56 € |
| 999 999 777095 | Q32 BORU BÜKME YAYI | 1 | 67,94 € |
| 999 999 777096 | Q40 BORU BÜKME YAYI | 1 | 107,76 € |
| 999 999 777097 | Q50 BORU BÜKME YAYI | 1 | 140,56 € |



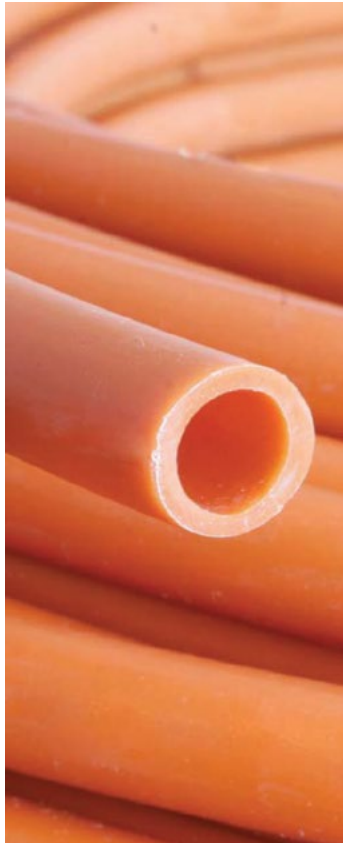

YENİ

YENİ MUTLUSAN EKO SERİSİ TURUNCU BORULAR - HALOJEN FREE - ALEV YAYAN - 320N - 6 ATÜ

| Ürün Kodu | Ürün Adı | Kutu Mt./Ad. | Fiyat (₺) |
|----------------------|---|--------------|-----------|
| 001 165 710014 00 12 | Ø14/6 ATÜ BORU (H.FREE TURUNCU) (A.YAYAN) (EKO) | 100 mt. | 10,19 |
| 001 165 710016 00 12 | Ø16/6 ATÜ BORU (H.FREE TURUNCU) (A.YAYAN) (EKO) | 100 mt. | 12,23 |
| 001 165 710018 00 12 | Ø18/6 ATÜ BORU (H.FREE TURUNCU) (A.YAYAN) (EKO) | 100 mt. | 14,27 |
| 001 165 710020 00 12 | Ø20/6 ATÜ BORU (H.FREE TURUNCU) (A.YAYAN) (EKO) | 100 mt. | 15,29 |
| 001 165 710025 00 12 | Ø25/6 ATÜ BORU (H.FREE TURUNCU) (A.YAYAN) (EKO) | 100 mt. | 23,24 |
| 001 165 710032 00 12 | Ø32/6 ATÜ BORU (H.FREE TURUNCU) (A.YAYAN) (EKO) | 100 mt. | 34,30 |
| 001 165 710040 00 12 | Ø40/6 ATÜ BORU (H.FREE TURUNCU) (A.YAYAN) (EKO) | 100 mt. | 52,81 |
| 001 165 710050 00 12 | Ø50/6 ATÜ BORU (H.FREE TURUNCU) (A.YAYAN) (EKO) | 100 mt. | 86,07 |

YENİ

YENİ MUTLUSAN EKO SERİSİ MAVİ BORULAR - HALOJEN FREE - ALEV YAYAN - 320N - 6 ATÜ

| Ürün Kodu | Ürün Adı | Kutu Mt./Ad. | Fiyat (₺) |
|----------------------|--|--------------|-----------|
| 001 165 710014 00 13 | Ø14/6 ATÜ BORU (H.FREE MAVİ) (A.YAYAN) (EKO) | 100 mt. | 10,19 |
| 001 165 710016 00 13 | Ø16/6 ATÜ BORU (H.FREE MAVİ) (A.YAYAN) (EKO) | 100 mt. | 12,23 |
| 001 165 710018 00 13 | Ø18/6 ATÜ BORU (H.FREE MAVİ) (A.YAYAN) (EKO) | 100 mt. | 14,27 |
| 001 165 710020 00 13 | Ø20/6 ATÜ BORU (H.FREE MAVİ) (A.YAYAN) (EKO) | 100 mt. | 15,29 |
| 001 165 710025 00 13 | Ø25/6 ATÜ BORU (H.FREE MAVİ) (A.YAYAN) (EKO) | 100 mt. | 23,24 |
| 001 165 710032 00 13 | Ø32/6 ATÜ BORU (H.FREE MAVİ) (A.YAYAN) (EKO) | 100 mt. | 34,30 |
| 001 165 710040 00 13 | Ø40/6 ATÜ BORU (H.FREE MAVİ) (A.YAYAN) (EKO) | 100 mt. | 52,81 |
| 001 165 710050 00 13 | Ø50/6 ATÜ BORU (H.FREE MAVİ) (A.YAYAN) (EKO) | 100 mt. | 86,07 |

MEKS SERİSİ TURUNCU BORULAR - HALOJEN FREE - ALEV YAYAN - 320N - 6 ATÜ

| Ürün Kodu | Ürün Adı | Kutu Mt./Ad. | Fiyat (₺) |
|----------------------|----------------------------------|--------------|-----------|
| 001 165 506014 00 12 | Ø14/6 ATÜ BORU (H.FREE)(A.YAYAN) | 100 mt. | 11,99 |
| 001 165 506016 00 12 | Ø16/6 ATÜ BORU (H.FREE)(A.YAYAN) | 100 mt. | 14,69 |
| 001 165 506018 00 12 | Ø18/6 ATÜ BORU (H.FREE)(A.YAYAN) | 100 mt. | 16,97 |
| 001 165 506020 00 12 | Ø20/6 ATÜ BORU (H.FREE)(A.YAYAN) | 100 mt. | 19,28 |
| 001 165 506025 00 12 | Ø25/6 ATÜ BORU (H.FREE)(A.YAYAN) | 100 mt. | 25,25 |
| 001 165 506032 00 12 | Ø32/6 ATÜ BORU (H.FREE)(A.YAYAN) | 100 mt. | 36,75 |
| 001 165 506037 00 12 | Ø37/6 ATÜ BORU (H.FREE)(A.YAYAN) | 100 mt. | 55,54 |
| 001 165 506040 00 12 | Ø40/6 ATÜ BORU (H.FREE)(A.YAYAN) | 100 mt. | 63,34 |
| 001 165 506050 00 12 | Ø50/6 ATÜ BORU (H.FREE)(A.YAYAN) | 100 mt. | 91,25 |
| 001 165 506063 00 12 | Ø63/6 ATÜ BORU (H.FREE)(A.YAYAN) | 100 mt. | 122,18 |
| 001 165 506075 00 12 | Ø75/6 ATÜ BORU (H.FREE)(A.YAYAN) | 100 mt. | 163,95 |
| 001 165 506090 00 12 | Ø90/6 ATÜ BORU (H.FREE)(A.YAYAN) | 100 mt. | 246,70 |

MEKS SERİSİ TURUNCU BORULAR - HALOJEN FREE - ALEV YAYAN - 750N - 10 ATÜ

| Ürün Kodu | Ürün Adı | Kutu Mt./Ad. | Fiyat (₺) |
|----------------------|------------------------------------|--------------|-----------|
| 001 165 510014 00 12 | Ø14/10 ATÜ BORU (H.FREE)(A.YAYAN) | 100 mt. | 13,13 |
| 001 165 510016 00 12 | Ø16/10 ATÜ BORU (H.FREE)(A.YAYAN) | 100 mt. | 16,21 |
| 001 165 510018 00 12 | Ø18/10 ATÜ BORU (H.FREE)(A.YAYAN) | 100 mt. | 19,28 |
| 001 165 510020 00 12 | Ø20/10 ATÜ BORU (H.FREE)(A.YAYAN) | 100 mt. | 23,45 |
| 001 165 510025 00 12 | Ø25/10 ATÜ BORU (H.FREE)(A.YAYAN) | 100 mt. | 27,66 |
| 001 165 510032 00 12 | Ø32/10 ATÜ BORU (H.FREE)(A.YAYAN) | 100 mt. | 40,09 |
| 001 165 510037 00 12 | Ø37/10 ATÜ BORU (H.FREE)(A.YAYAN) | 100 mt. | 68,26 |
| 001 165 510040 00 12 | Ø40/10 ATÜ BORU (H.FREE)(A.YAYAN) | 100 mt. | 73,02 |
| 001 165 510050 00 12 | Ø50/10 ATÜ BORU (H.FREE)(A.YAYAN) | 100 mt. | 108,04 |
| 001 165 510063 00 12 | Ø63/10 ATÜ BORU (H.FREE)(A.YAYAN) | 100 mt. | 139,65 |
| 001 165 510075 00 12 | Ø75/10 ATÜ BORU (H.FREE)(A.YAYAN) | 100 mt. | 176,69 |
| 001 165 510090 00 12 | Ø90/10 ATÜ BORU (H.FREE)(A.YAYAN) | 100 mt. | 275,29 |
| 001 165 510100 00 12 | Ø100/10 ATÜ BORU (H.FREE)(A.YAYAN) | 100 mt. | 358,83 |
| 001 165 510110 00 12 | Ø110/10 ATÜ BORU (H.FREE)(A.YAYAN) | 100 mt. | 401,13 |

MEKS SERİSİ TURUNCU BORULAR - HALOJEN FREE - ALEV YAYAN - 1250N

| Ürün Kodu | Ürün Adı | Kutu Mt./Ad. | Fiyat (₺) |
|----------------------|-----------------------------|--------------|-----------|
| 001 165 512020 00 12 | 20 Ø BORU (H.FREE)(A.YAYAN) | 100 mt. | 42,43 |
| 001 165 512025 00 12 | 25 Ø BORU (H.FREE)(A.YAYAN) | 100 mt. | 54,28 |
| 001 165 512032 00 12 | 32 Ø BORU (H.FREE)(A.YAYAN) | 100 mt. | 85,25 |

MEKS SERİSİ TURUNCU BORULAR - HALOJEN FREE - ALEV YAYMAYAN - 320N - 6 ATÜ

| Ürün Kodu | Ürün Adı | Kutu Mt./Ad. | Fiyat (₺) |
|----------------------|-------------------------------------|--------------|-----------|
| 001 165 106014 00 12 | Ø14/6 ATÜ BORU (H.FREE)(A.YAYMAYAN) | 100 mt. | 17,80 |
| 001 165 106016 00 12 | Ø16/6 ATÜ BORU (H.FREE)(A.YAYMAYAN) | 100 mt. | 22,07 |
| 001 165 106018 00 12 | Ø18/6 ATÜ BORU (H.FREE)(A.YAYMAYAN) | 100 mt. | 25,69 |
| 001 165 106020 00 12 | Ø20/6 ATÜ BORU (H.FREE)(A.YAYMAYAN) | 100 mt. | 29,96 |
| 001 165 106025 00 12 | Ø25/6 ATÜ BORU (H.FREE)(A.YAYMAYAN) | 100 mt. | 40,04 |
| 001 165 106032 00 12 | Ø32/6 ATÜ BORU (H.FREE)(A.YAYMAYAN) | 100 mt. | 60,09 |
| 001 165 106037 00 12 | Ø37/6 ATÜ BORU (H.FREE)(A.YAYMAYAN) | 100 mt. | 84,26 |
| 001 165 106040 00 12 | Ø40/6 ATÜ BORU (H.FREE)(A.YAYMAYAN) | 100 mt. | 90,45 |
| 001 165 106050 00 12 | Ø50/6 ATÜ BORU (H.FREE)(A.YAYMAYAN) | 100 mt. | 135,36 |
| 001 165 106063 00 12 | Ø63/6 ATÜ BORU (H.FREE)(A.YAYMAYAN) | 100 mt. | 197,66 |
| 001 165 106075 00 12 | Ø75/6 ATÜ BORU (H.FREE)(A.YAYMAYAN) | 100 mt. | 257,11 |
| 001 165 106090 00 12 | Ø90/6 ATÜ BORU (H.FREE)(A.YAYMAYAN) | 75 mt. | 389,99 |

MEKS SERİSİ TURUNCU BORULAR - HALOJEN FREE - ALEV YAYMAYAN - 750N - 10 ATÜ

| Ürün Kodu | Ürün Adı | Kutu Mt./Ad. | Fiyat (₺) |
|----------------------|---------------------------------------|--------------|-----------|
| 001 165 110014 00 12 | Ø14/10 ATÜ BORU (H.FREE)(A.YAYMAYAN) | 100 mt. | 19,90 |
| 001 165 110016 00 12 | Ø16/10 ATÜ BORU (H.FREE)(A.YAYMAYAN) | 100 mt. | 24,91 |
| 001 165 110018 00 12 | Ø18/10 ATÜ BORU (H.FREE)(A.YAYMAYAN) | 100 mt. | 29,96 |
| 001 165 110020 00 12 | Ø20/10 ATÜ BORU (H.FREE)(A.YAYMAYAN) | 100 mt. | 37,07 |
| 001 165 110025 00 12 | Ø25/10 ATÜ BORU (H.FREE)(A.YAYMAYAN) | 100 mt. | 45,73 |
| 001 165 110032 00 12 | Ø32/10 ATÜ BORU (H.FREE)(A.YAYMAYAN) | 100 mt. | 68,63 |
| 001 165 110037 00 12 | Ø37/10 ATÜ BORU (H.FREE)(A.YAYMAYAN) | 100 mt. | 95,51 |
| 001 165 110040 00 12 | Ø40/10 ATÜ BORU (H.FREE)(A.YAYMAYAN) | 100 mt. | 116,15 |
| 001 165 110050 00 12 | Ø50/10 ATÜ BORU (H.FREE)(A.YAYMAYAN) | 100 mt. | 159,86 |
| 001 165 110063 00 12 | Ø63/10 ATÜ BORU (H.FREE)(A.YAYMAYAN) | 100 mt. | 226,55 |
| 001 165 110075 00 12 | Ø75/10 ATÜ BORU (H.FREE)(A.YAYMAYAN) | 100 mt. | 265,65 |
| 001 165 110090 00 12 | Ø90/10 ATÜ BORU (H.FREE)(A.YAYMAYAN) | 75 mt. | 450,80 |
| 001 165 110100 00 12 | Ø100/10 ATÜ BORU (H.FREE)(A.YAYMAYAN) | 50 mt. | 543,95 |
| 001 165 110110 00 12 | Ø110/10 ATÜ BORU (H.FREE)(A.YAYMAYAN) | 50 mt. | 604,39 |

| Ürün Kodu | Ürün Adı | Kutu Mt./Ad. | Koli Adet | Fiyat (₺) |
|-----------|----------|--------------|-----------|-----------|
|-----------|----------|--------------|-----------|-----------|

MEKS SERİSİ BORULAR - HALOJEN FREE - ALEV YAYMAYAN - 1250N

| | | | | |
|----------------------|--------------------------------|---------|--|--------|
| 001 165 112020 00 12 | 20 Ø BORU (H.FREE)(A.YAYMAYAN) | 100 mt. | | 66,07 |
| 001 165 112025 00 12 | 25 Ø BORU (H.FREE)(A.YAYMAYAN) | 100 mt. | | 84,26 |
| 001 165 112032 00 12 | 32 Ø BORU (H.FREE)(A.YAYMAYAN) | 100 mt. | | 126,31 |

MEKS SERİSİ TURUNCU BORU - HALOJEN FREE - ALEV YAYAN - TELLİ - 320N - 6 ATÜ

| | | | | |
|----------------------|---|---------|--|-------|
| 001 165 906014 00 12 | Ø14/6 ATÜ BORU(H.FREE)(A.YAYAN)(TELLİ)(TURUNCU) | 100 mt. | | 13,63 |
| 001 165 906016 00 12 | Ø16/6 ATÜ BORU(H.FREE)(A.YAYAN)(TELLİ)(TURUNCU) | 100 mt. | | 16,33 |
| 001 165 906018 00 12 | Ø18/6 ATÜ BORU(H.FREE)(A.YAYAN)(TELLİ)(TURUNCU) | 100 mt. | | 18,61 |
| 001 165 906020 00 12 | Ø20/6 ATÜ BORU(H.FREE)(A.YAYAN)(TELLİ)(TURUNCU) | 100 mt. | | 20,92 |
| 001 165 906025 00 12 | Ø25/6 ATÜ BORU(H.FREE)(A.YAYAN)(TELLİ)(TURUNCU) | 100 mt. | | 26,89 |
| 001 165 906032 00 12 | Ø32/6 ATÜ BORU(H.FREE)(A.YAYAN)(TELLİ)(TURUNCU) | 100 mt. | | 38,39 |
| 001 165 906037 00 12 | Ø37/6 ATÜ BORU(H.FREE)(A.YAYAN)(TELLİ)(TURUNCU) | 100 mt. | | 57,18 |
| 001 165 906040 00 12 | Ø40/6 ATÜ BORU(H.FREE)(A.YAYAN)(TELLİ)(TURUNCU) | 100 mt. | | 64,98 |

MEKS SERİSİ TURUNCU BORU - HALOJEN FREE - ALEV YAYAN - TELLİ - 750N - 10 ATÜ

| | | | | |
|----------------------|--|---------|--|-------|
| 001 165 910014 00 12 | Ø14/10 ATÜ BORU(H.FREE)(A.YAYAN)(TELLİ)(TURUNCU) | 100 mt. | | 14,77 |
| 001 165 910016 00 12 | Ø16/10 ATÜ BORU(H.FREE)(A.YAYAN)(TELLİ)(TURUNCU) | 100 mt. | | 17,85 |
| 001 165 910018 00 12 | Ø18/10 ATÜ BORU(H.FREE)(A.YAYAN)(TELLİ)(TURUNCU) | 100 mt. | | 20,92 |
| 001 165 910020 00 12 | Ø20/10 ATÜ BORU(H.FREE)(A.YAYAN)(TELLİ)(TURUNCU) | 100 mt. | | 25,09 |
| 001 165 910025 00 12 | Ø25/10 ATÜ BORU(H.FREE)(A.YAYAN)(TELLİ)(TURUNCU) | 100 mt. | | 29,30 |
| 001 165 910032 00 12 | Ø32/10 ATÜ BORU(H.FREE)(A.YAYAN)(TELLİ)(TURUNCU) | 100 mt. | | 41,73 |
| 001 165 910037 00 12 | Ø37/10 ATÜ BORU(H.FREE)(A.YAYAN)(TELLİ)(TURUNCU) | 100 mt. | | 69,90 |
| 001 165 910040 00 12 | Ø40/10 ATÜ BORU(H.FREE)(A.YAYAN)(TELLİ)(TURUNCU) | 100 mt. | | 74,66 |

MEKS SERİSİ BORULAR - HALOJEN FREE - ALEV YAYMAYAN - TELLİ - 320N - 6 ATÜ

| | | | | |
|----------------------|--|---------|--|-------|
| 001 165 306014 00 12 | Ø14/6 ATÜ BORU(H.FREE)(A.YAYMAYAN)(TELLİ)(TURUNCU) | 100 mt. | | 18,73 |
| 001 165 306016 00 12 | Ø16/6 ATÜ BORU(H.FREE)(A.YAYMAYAN)(TELLİ)(TURUNCU) | 100 mt. | | 23,00 |
| 001 165 306018 00 12 | Ø18/6 ATÜ BORU(H.FREE)(A.YAYMAYAN)(TELLİ)(TURUNCU) | 100 mt. | | 26,63 |
| 001 165 306020 00 12 | Ø20/6 ATÜ BORU(H.FREE)(A.YAYMAYAN)(TELLİ)(TURUNCU) | 100 mt. | | 30,90 |
| 001 165 306025 00 12 | Ø25/6 ATÜ BORU(H.FREE)(A.YAYMAYAN)(TELLİ)(TURUNCU) | 100 mt. | | 41,69 |
| 001 165 306032 00 12 | Ø32/6 ATÜ BORU(H.FREE)(A.YAYMAYAN)(TELLİ)(TURUNCU) | 100 mt. | | 63,15 |
| 001 165 306037 00 12 | Ø37/6 ATÜ BORU(H.FREE)(A.YAYMAYAN)(TELLİ)(TURUNCU) | 100 mt. | | 85,20 |
| 001 165 306040 00 12 | Ø40/6 ATÜ BORU(H.FREE)(A.YAYMAYAN)(TELLİ)(TURUNCU) | 100 mt. | | 94,56 |

MEKS SERİSİ BORULAR - HALOJEN FREE - ALEV YAYMAYAN - TELLİ - 750N - 10 ATÜ

| | | | | |
|----------------------|---|---------|--|--------|
| 001 165 310014 00 12 | Ø14/10 ATÜ BORU(H.FREE)(A.YAYMAYAN)(TELLİ)(TURUNCU) | 100 mt. | | 20,84 |
| 001 165 310016 00 12 | Ø16/10 ATÜ BORU(H.FREE)(A.YAYMAYAN)(TELLİ)(TURUNCU) | 100 mt. | | 25,85 |
| 001 165 310018 00 12 | Ø18/10 ATÜ BORU(H.FREE)(A.YAYMAYAN)(TELLİ)(TURUNCU) | 100 mt. | | 30,90 |
| 001 165 310020 00 12 | Ø20/10 ATÜ BORU(H.FREE)(A.YAYMAYAN)(TELLİ)(TURUNCU) | 100 mt. | | 38,01 |
| 001 165 310025 00 12 | Ø25/10 ATÜ BORU(H.FREE)(A.YAYMAYAN)(TELLİ)(TURUNCU) | 100 mt. | | 46,67 |
| 001 165 310032 00 12 | Ø32/10 ATÜ BORU(H.FREE)(A.YAYMAYAN)(TELLİ)(TURUNCU) | 100 mt. | | 69,56 |
| 001 165 310037 00 12 | Ø37/10 ATÜ BORU(H.FREE)(A.YAYMAYAN)(TELLİ)(TURUNCU) | 100 mt. | | 96,44 |
| 001 165 310040 00 12 | Ø40/10 ATÜ BORU(H.FREE)(A.YAYMAYAN)(TELLİ)(TURUNCU) | 100 mt. | | 117,09 |

PLASTİK BORULAR

| | | | | |
|----------------------|-------------------------------|---------|---------|-------|
| 001 045 000014 30 00 | 14 MM KALIN BOY BORU | 102 mt. | 510 mt. | 10,47 |
| 001 045 000018 30 00 | 18 MM KALIN BOY BORU | 102 mt. | 510 mt. | 12,44 |
| 001 045 000026 30 00 | 26 MM KALIN BOY BORU | 51 mt. | 255 mt. | 21,28 |
| 001 045 000037 30 00 | 37 MM KALIN BOY BORU | 30 mt. | | 39,46 |
| 001 045 010014 00 11 | 14 MM KANGAL (NORMAL) | 100 mt. | | 10,47 |
| 001 045 010018 00 11 | 18 MM KANGAL (NORMAL) | 100 mt. | | 12,44 |
| 001 045 010026 00 11 | 26 MM KANGAL (NORMAL) | 50 mt. | | 21,28 |
| 001 045 010037 00 11 | 37 MM KANGAL (NORMAL) | 50 mt. | | 48,20 |
| 001 045 020014 00 00 | 14 MM KANGAL (KAUÇUK) | 100 mt. | | 10,84 |
| 001 045 020018 00 00 | 18 MM KANGAL (KAUÇUK) | 100 mt. | | 13,06 |
| 001 045 020026 00 00 | 26 MM KANGAL (KAUÇUK) | 50 mt. | | 21,00 |
| 001 045 020037 00 00 | 37 MM KANGAL (KAUÇUK) | 50 mt. | | 38,97 |
| 001 045 030014 00 00 | 14 MM KANGAL (KAUÇUK) (KALIN) | 100 mt. | | 12,27 |
| 001 045 030018 00 00 | 18 MM KANGAL (KAUÇUK) (KALIN) | 100 mt. | | 13,77 |

PLASTİK DİRSEK VE MUFLAR

| | | | | |
|----------------------|---------------------|---------|------|------|
| 127 051 000014 | PLASTİK 14 Ø DİRSEK | 100 ad. | 2000 | 3,90 |
| 127 051 000018 | PLASTİK 18 Ø DİRSEK | 100 ad. | 1000 | 4,80 |
| 127 051 000026 | PLASTİK 26 Ø DİRSEK | 100 ad. | 500 | 8,70 |
| 001 051 020014 00 11 | PLASTİK 14 Ø MUF | | 1500 | 2,94 |
| 001 051 020018 00 11 | PLASTİK 18 Ø MUF | | 1000 | 4,75 |
| 001 051 020026 00 11 | PLASTİK 26 Ø MUF | | 500 | 6,79 |
| 001 051 020037 00 11 | PLASTİK 37 Ø MUF | | 250 | 9,37 |

POLİETİLEN SİYAH YERALTI BORULAR - 450N

| | | | | |
|----------------------|----------------------------------|---------|--|--------|
| 001 165 406014 00 11 | 14/6 ATÜ POLİETİLEN BORU (SİYAH) | 100 mt. | | 10,54 |
| 001 165 406016 00 11 | 16/6 ATÜ POLİETİLEN BORU (SİYAH) | 100 mt. | | 12,14 |
| 001 165 406018 00 11 | 18/6 ATÜ POLİETİLEN BORU (SİYAH) | 100 mt. | | 13,61 |
| 001 165 406020 00 11 | 20/6 ATÜ POLİETİLEN BORU (SİYAH) | 100 mt. | | 14,95 |
| 001 165 406025 00 11 | 25/6 ATÜ POLİETİLEN BORU (SİYAH) | 100 mt. | | 21,02 |
| 001 165 406032 00 11 | 32/6 ATÜ POLİETİLEN BORU (SİYAH) | 100 mt. | | 33,14 |
| 001 165 406037 00 11 | 37/6 ATÜ POLİETİLEN BORU (SİYAH) | 100 mt. | | 46,43 |
| 001 165 406040 00 11 | 40/6 ATÜ POLİETİLEN BORU (SİYAH) | 100 mt. | | 49,82 |
| 001 165 406050 00 11 | 50/6 ATÜ POLİETİLEN BORU (SİYAH) | 100 mt. | | 79,72 |
| 001 165 406063 00 11 | 63/6 ATÜ POLİETİLEN BORU (SİYAH) | 100 mt. | | 106,65 |
| 001 165 406075 00 11 | 75/6 ATÜ POLİETİLEN BORU (SİYAH) | 100 mt. | | 155,90 |
| 001 165 406090 00 11 | 90/6 ATÜ POLİETİLEN BORU (SİYAH) | 75 mt. | | 224,51 |

POLİETİLEN SİYAH YER ALTI BORULAR - 750N

| | | | | |
|----------------------|------------------------------------|---------|--|--------|
| 001 165 410014 00 11 | 14/10 ATÜ POLİETİLEN BORU (SİYAH) | 100 mt. | | 11,34 |
| 001 165 410016 00 11 | 16/10 ATÜ POLİETİLEN BORU (SİYAH) | 100 mt. | | 12,81 |
| 001 165 410018 00 11 | 18/10 ATÜ POLİETİLEN BORU (SİYAH) | 100 mt. | | 14,95 |
| 001 165 410020 00 11 | 20/10 ATÜ POLİETİLEN BORU (SİYAH) | 100 mt. | | 18,38 |
| 001 165 410025 00 11 | 25/10 ATÜ POLİETİLEN BORU (SİYAH) | 100 mt. | | 23,47 |
| 001 165 410032 00 11 | 32/10 ATÜ POLİETİLEN BORU (SİYAH) | 100 mt. | | 36,70 |
| 001 165 410037 00 11 | 37/10 ATÜ POLİETİLEN BORU (SİYAH) | 100 mt. | | 48,48 |
| 001 165 410040 00 11 | 40/10 ATÜ POLİETİLEN BORU (SİYAH) | 100 mt. | | 55,16 |
| 001 165 410050 00 11 | 50/10 ATÜ POLİETİLEN BORU (SİYAH) | 100 mt. | | 102,56 |
| 001 165 410063 00 11 | 63/10 ATÜ POLİETİLEN BORU (SİYAH) | 100 mt. | | 127,06 |
| 001 165 410075 00 11 | 75/10 ATÜ POLİETİLEN BORU (SİYAH) | 100 mt. | | 167,98 |
| 001 165 410090 00 11 | 90/10 ATÜ POLİETİLEN BORU (SİYAH) | 100 mt. | | 260,87 |
| 001 165 410100 00 11 | 100/10 ATÜ POLİETİLEN BORU (SİYAH) | 100 mt. | | 327,19 |
| 001 165 410110 00 11 | 110/10 ATÜ POLİETİLEN BORU (SİYAH) | 75 mt. | | 381,86 |



001 046 130107 00 11



001 046 170102 00 11



001 046 130101 00 11



001 046 170101 00 11



001 046 000001 00 11



001 046 130102 00 11



001 046 130201 00 12

001 046 160201 00 12



001 046 130202 00 12

001 046 120101 00 12

001 046 120103 00 12



001 046 120100 00 12

001 046 131101 00 12

001 046 161101 00 12



000 700 000215 00 12

000 700 000214 00 14



000 700 000036 00 14

000 700 000035 00 12



000 700 000039 00 12

000 700 000256 00 12



001 046 000103 00 00



001 046 000103 00 11

| Ürün Kodu | Ürün Adı | Kutu Mt./Ad. | Koli Adet | Fiyat (₺) |
|--|---|--------------|-----------|-----------|
| PLASTİK KASA - BUAT - TAKOZLAR | | | | |
| 001 046 130102 00 11 | NORM KASA | 100 ad. | 1000 | 5,20 |
| 001 046 130101 00 11 | NORM BUAT (14-18 ÇIKIŞLI) | 50 ad. | 500 | 10,30 |
| 001 046 130105 00 11 | NORM BUAT KAPAKSIZ | 50 ad. | 500 | 7,70 |
| 001 046 160102 00 11 | GEÇMELİ PLASTİK KASA | 100 ad. | 400 | 15,90 |
| 001 046 160101 00 11 | GEÇMELİ DERİN KASA | 100 ad. | 500 | 9,10 |
| 001 046 130107 00 11 | GEÇMELİ DERİN KASA KAPAKSIZ | 100 ad. | 500 | 7,00 |
| 001 046 120101 00 11 | ALÇIPAN KASA 1'Lİ | 75 ad. | 300 | 23,10 |
| 001 046 120102 00 11 | ALÇIPAN KASA 2'Lİ | 50 ad. | 200 | 35,10 |
| 001 046 120103 00 11 | ALÇIPAN KASA 3'Lİ | 25 ad. | 100 | 51,10 |
| 001 046 120100 00 11 | GEÇMELİ ALÇ.KASA SİYAH | 50 ad. | 300 | 14,10 |
| 001 046 170101 00 11 | TÜNEL KASA | 100 ad. | 500 | 27,00 |
| 001 046 170102 00 11 | TÜNEL BUAT | 50 ad. | 300 | 17,40 |
| 001 046 000001 00 11 | PLASTİK TAKOZ (14-18 ÇIKIŞLI) | 100 ad. | 1000 | 8,10 |
| TURUNCU KASA VE BUATLAR - HALOJEN FREE - ALEV YAYAN | | | | |
| 001 046 130202 00 12 | NORM KASA (TURUNCU) (H.FREE) (ALEV YAYAN) | 100 ad. | 1000 | 9,40 |
| 001 046 130201 00 12 | NORM BUAT (TURUNCU) (H.FREE) (ALEV YAYAN) | 50 ad. | 500 | 15,90 |
| 001 046 160201 00 12 | GEÇMELİ DERİN KASA (TURUNCU) (H.FREE) (ALEV YAYAN) | 100 ad. | 500 | 16,60 |
| TURUNCU KASA VE BUATLAR - ALEV YAYAN | | | | |
| 001 046 130102 00 12 | NORM KASA (TURUNCU)(ALEV YAYAN) | 100 ad. | 1000 | 7,00 |
| 001 046 130101 00 12 | NORM BUAT (TURUNCU)(ALEV YAYAN) | 50 ad. | 500 | 13,10 |
| 001 046 160102 00 12 | GEÇMELİ PLASTİK KASA (TURUNCU)(ALEV YAYAN) | 100 ad. | 400 | 15,40 |
| 001 046 160101 00 12 | GEÇMELİ DERİN KASA (TURUNCU)(ALEV YAYAN) | 100 ad. | 500 | 15,40 |
| 001 046 170101 00 12 | TÜNEL KASA (TURUNCU)(ALEV YAYAN) | 100 ad. | 500 | 25,20 |
| 001 046 170102 00 12 | TÜNEL BUAT (TURUNCU)(ALEV YAYAN) | 50 ad. | 300 | 18,00 |
| 001 046 120101 00 12 | ALÇIPAN KASA 1'Lİ (TURUNCU)(ALEV YAYAN) | 75 ad. | 300 | 24,50 |
| 001 046 120102 00 12 | ALÇIPAN KASA 2'Lİ (TURUNCU)(ALEV YAYAN) | 50 ad. | 200 | 37,30 |
| 001 046 120103 00 12 | ALÇIPAN KASA 3'LÜ (TURUNCU)(ALEV YAYAN) | 25 ad. | 100 | 53,90 |
| 001 046 120100 00 12 | GEÇMELİ ALÇIPAN KASA (TURUNCU)(ALEV YAYAN) | 50 ad. | 300 | 17,80 |
| TURUNCU KASA VE BUATLAR - ALEV YAYMAYAN | | | | |
| 001 046 131102 00 12 | NORM KASA (TURUNCU)(ALEV YAYMAYAN) | 100 ad. | 1000 | 9,90 |
| 001 046 131101 00 12 | NORM BUAT (TURUNCU)(ALEV YAYMAYAN) | 50 ad. | 500 | 16,00 |
| 001 046 161102 00 12 | GEÇMELİ PLASTİK KASA (TURUNCU)(ALEV YAYMAYAN) | 100 ad. | 400 | 26,30 |
| 001 046 161101 00 12 | GEÇMELİ DERİN KASA (TURUNCU)(ALEV YAYMAYAN) | 100 ad. | 500 | 19,20 |
| 001 046 210002 00 12 | TÜNEL KASA (TURUNCU)(ALEV YAYMAYAN) | 100 ad. | 500 | 34,20 |
| 001 046 210003 00 12 | TÜNEL BUAT (TURUNCU)(ALEV YAYMAYAN) | 50 ad. | 300 | 27,50 |
| 001 046 121101 00 12 | ALÇIPAN KASA 1'Lİ (TURUNCU)(ALEV YAYMAYAN) | 75 ad. | 300 | 26,90 |
| 001 046 121102 00 12 | ALÇIPAN KASA 2'Lİ (TURUNCU)(ALEV YAYMAYAN) | 50 ad. | 200 | 42,00 |
| 001 046 121103 00 12 | ALÇIPAN KASA 3'LÜ (TURUNCU)(ALEV YAYMAYAN) | 25 ad. | 100 | 61,20 |
| 001 046 121100 00 12 | GEÇMELİ ALÇIPAN KASA (TURUNCU)(ALEV YAYMAYAN) | 50 ad. | 300 | 22,00 |
| BETON DUVAR ANAHTAR KASALARI - ALEV YAYAN | | | | |
| 000 700 000037 00 14 | BUAT ARKA KAPAK SARI (ALEV YAYAN) | 50 ad. | 500 | 6,30 |
| 000 700 000035 00 12 | BUAT GÖVDE 60'LİK TURUNCU (ALEV YAYAN) | 50 ad. | 350 | 13,00 |
| 000 700 000256 00 14 | KALIBA TESPİT ELEMANI SARI (ALEV YAYAN) | | 250 | 8,10 |
| 000 700 000039 00 12 | SİĞ BRÜT ANAH. KASASI TURUNCU (ALEV YAYAN) | 100 ad. | 500 | 20,00 |
| 000 700 000036 00 14 | KONİK GÖVDE SARI (ALEV YAYAN) | 50 ad. | 250 | 11,10 |
| 000 700 000214 00 14 | APLİK 20'LİK SARI (ALEV YAYAN) | 100 ad. | 1000 | 5,60 |
| 000 700 000215 00 12 | APLİK EĞİK BAĞLANTI DİRSEĞİ TURUNCU (ALEV YAYAN) | 100 ad. | 1000 | 4,80 |
| BETON DUVAR ANAHTAR KASALARI - ALEV YAYMAYAN | | | | |
| 000 700 200037 00 14 | BUAT ARKA KAPAK SARI (ALEV YAYMAYAN) | 50 ad. | 500 | 7,90 |
| 000 700 200035 00 12 | BUAT GÖVDE 60'LİK TURUNCU (ALEV YAYMAYAN) | 50 ad. | 350 | 15,50 |
| 000 700 200256 00 14 | KALIBA TESPİT ELEMANI SARI (ALEV YAYMAYAN) | | 250 | 11,00 |
| 000 700 200039 00 12 | SİĞ BRÜT ANAH. KASASI TURUNCU (ALEV YAYMAYAN) | 100 ad. | 500 | 32,40 |
| 000 700 200036 00 14 | KONİK GÖVDE SARI (ALEV YAYMAYAN) | 50 ad. | 250 | 16,60 |
| 000 700 200214 00 14 | APLİK 20'LİK SARI (ALEV YAYMAYAN) | 100 ad. | 1000 | 6,10 |
| 000 700 200215 00 12 | APLİK EĞİK BAĞLANTI DİRSEĞİ TURUNCU (ALEV YAYMAYAN) | 100 ad. | 1000 | 8,60 |

| Ürün Kodu | Ürün Adı | Kutu Mt./Ad. | Koli Adet | Fiyat (₺) |
|----------------------|------------------------------------|--------------|-----------|-----------|
| KARE BUAT | | | | |
| 001 046 021010 00 11 | 10X10 KARE BUAT (SİYAH) | 10 ad. | 300 | 74,60 |
| 001 046 021212 00 11 | 12X12 KARE BUAT (SİYAH) | 10 ad. | 200 | 77,40 |
| 001 046 021515 00 11 | 15X15 KARE BUAT (SİYAH) | 10 ad. | 120 | 113,80 |
| 001 046 022020 00 11 | 20X20 KARE BUAT (SİYAH) | 10 ad. | 70 | 146,30 |
| 001 046 000103 00 11 | ANTİGRON BUAT 3'LÜ PLASTİK (SİYAH) | 10 ad. | 240 | 59,30 |
| 001 046 000104 00 11 | ANTİGRON BUAT 4'LÜ PLASTİK (SİYAH) | 10 ad. | 240 | 68,00 |
| 001 046 000103 00 00 | ANTİGRON BUAT 3'LÜ PLASTİK (BEYAZ) | 10 ad. | 240 | 59,80 |
| 001 046 000104 00 00 | ANTİGRON BUAT 4'LÜ PLASTİK (BEYAZ) | 10 ad. | 240 | 69,50 |
| 001 046 021010 00 12 | 10X10 KARE BUAT TURUNCU | 10 ad. | 300 | 77,60 |
| 001 046 021212 00 12 | 12X12 KARE BUAT TURUNCU | 10 ad. | 200 | 85,20 |
| 001 046 021515 00 12 | 15X15 KARE BUAT TURUNCU | 10 ad. | 120 | 122,70 |
| 001 046 022020 00 12 | 20X20 KARE BUAT TURUNCU | 10 ad. | 70 | 150,40 |
| 001 046 000103 00 12 | ANTİGRON BUAT 3'LÜ TURUNCU | 10 ad. | 240 | 59,70 |
| 001 046 000104 00 12 | ANTİGRON BUAT 4'LÜ TURUNCU | 10 ad. | 240 | 68,90 |



001 046 021212 00 11



001 046 021212 00 12

TURUNCU KARE BUAT - ALEV YAYMAYAN



| | | | | |
|----------------------|---------------------------------------|--------|-----|--------|
| 001 046 051010 00 12 | KARE BUAT TURUNCU(10X10) (A.YAYMAYAN) | 10 ad. | 300 | 85,90 |
| 001 046 051212 00 12 | KARE BUAT TURUNCU(12X12) (A.YAYMAYAN) | 10 ad. | 200 | 92,80 |
| 001 046 051515 00 12 | KARE BUAT TURUNCU(15X15) (A.YAYMAYAN) | 10 ad. | 120 | 144,00 |
| 001 046 052020 00 12 | KARE BUAT TURUNCU(20X20) (A.YAYMAYAN) | 10 ad. | 70 | 185,20 |

LÜKS BUAT KAPAKLARI

| | | | | |
|----------------|---------------------------------------|---------|------|-------|
| 126 046 180001 | LÜKS BUAT KAPAĞI(BOMBELİ-PLS. AYAK) | 100 ad. | 1000 | 5,40 |
| 126 046 180003 | LÜKS BUAT KAPAĞI(DÜZ PLS. AYAK) | 100 ad. | 1000 | 5,70 |
| 126 046 180004 | LÜKS BUAT KAPAĞI(BOMB.PLS.AYAK)VİDALI | 100 ad. | 1000 | 16,40 |

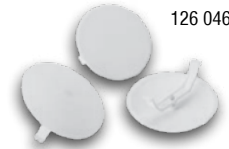

126 046 180003

126 046 180001

126 046 180004

KARE BUAT KAPAKLARI

| | | | | |
|----------------------|------------------------|-------|-----|-------|
| 000 700 000043 00 00 | 10X10 KARE BUAT KAPAĞI | 1 ad. | 300 | 16,80 |
| 000 700 000045 00 00 | 12X12 KARE BUAT KAPAĞI | 1 ad. | 350 | 21,40 |
| 000 700 000047 00 00 | 15X15 KARE BUAT KAPAĞI | 1 ad. | 260 | 30,30 |
| 000 700 000049 00 00 | 20X20 KARE BUAT KAPAĞI | 1 ad. | 140 | 56,20 |

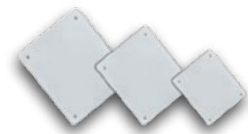

000 700 000047 00 00

| Ürün Kodu | Ürün Adı | Kutu Mt./Ad. | Koli Adet | Fiyat (₺) |
|-----------|----------|--------------|-----------|-----------|
|-----------|----------|--------------|-----------|-----------|

MUTLUSAN BETON ÇİVİLİ KROŞELER

| | | | | | |
|----------------|--|----------|----------|-------|------|
| 032 048 070000 | NO:0 BETON ÇİVİLİ KROŞE(0.75 YASSIKORD.) | MUTLUSAN | 1000 ad. | 20000 | 0,65 |
| 032 048 070001 | NO:1 BETON ÇİVİLİ KROŞE(0.75 YASSIKORD.) | MUTLUSAN | 1000 ad. | 20000 | 0,65 |
| 032 048 070002 | NO:2 BETON ÇİVİLİ KROŞE(0.75 YASSIKORD.) | MUTLUSAN | 1000 ad. | 20000 | 0,65 |
| 032 048 070003 | NO:3 BETON ÇİVİLİ KROŞE (2X1.5-3X1.5) | MUTLUSAN | 1000 ad. | 20000 | 0,77 |
| 032 048 070004 | NO:4 BETON ÇİVİLİ KROŞE (2X4) | MUTLUSAN | 1000 ad. | 20000 | 0,77 |
| 032 048 070005 | NO:5 BETON ÇİVİLİ KROŞE (2X4-4X4) | MUTLUSAN | 1000 ad. | 10000 | 0,94 |
| 032 048 070006 | NO:6 BETON ÇİVİLİ KROŞE (2X6) | MUTLUSAN | 1000 ad. | 10000 | 1,04 |
| 032 048 070007 | NO:7 BETON ÇİVİLİ KROŞE (4X10) | MUTLUSAN | 1000 ad. | 5000 | 1,62 |
| 032 048 070008 | NO:8 BETON ÇİVİLİ KROŞE (3X16+10) | MUTLUSAN | 800 ad. | 3200 | 2,44 |





| Ürün Kodu | Ürün Adı | Kutu Mt./ Ad. | Koli Adet | Fiyat (₺) |
|--------------------------------|---------------------------------------|---------------|-----------|-----------|
| GALVANİZLİ SAC KROŞELER | | | | |
| 001 048 060001 00 00 | NO. 1 TEKLİ GALVANİZ SAC KROŞE 12MM | 1500 ad. | | 2,90 |
| 001 048 060002 00 00 | NO. 2 TEKLİ GALVANİZ SAC KROŞE 14MM | 1000 ad. | | 2,90 |
| 001 048 060003 00 00 | NO. 3 TEKLİ GALVANİZ SAC KROŞE 17MM | 700 ad. | | 3,50 |
| 001 048 060004 00 00 | NO. 4 TEKLİ GALVANİZ SAC KROŞE 20MM | 500 ad. | | 3,60 |
| 001 048 060007 00 00 | NO. 7 TEKLİ GALVANİZ SAC KROŞE 26MM | 350 ad. | | 4,60 |
| 001 048 060008 00 00 | NO. 8 TEKLİ GALVANİZ SAC KROŞE 34MM | 250 ad. | | 11,10 |
| 001 048 060009 00 00 | NO. 9 TEKLİ GALVANİZ SAC KROŞE 43MM | 200 ad. | | 12,70 |
| 001 048 060010 00 00 | NO. 10 TEKLİ GALVANİZ SAC KROŞE 53MM | 150 ad. | | 13,60 |
| 001 048 060011 00 00 | NO. 11 TEKLİ GALVANİZ SAC KROŞE 55MM | 120 ad. | | 15,70 |
| 001 048 070002 00 00 | NO. 2 ÇİFTLİ GALVANİZ SAC KROŞE 13MM | 600 ad. | | 3,40 |
| 001 048 070003 00 00 | NO. 3 ÇİFTLİ GALVANİZ SAC KROŞE 16MM | 500 ad. | | 4,00 |
| 001 048 070004 00 00 | NO. 4 ÇİFTLİ GALVANİZ SAC KROŞE 22MM | 400 ad. | | 4,10 |
| 001 048 070007 00 00 | NO. 7 ÇİFTLİ GALVANİZ SAC KROŞE 25MM | 400 ad. | | 4,80 |
| 001 048 070008 00 00 | NO. 8 ÇİFTLİ GALVANİZ SAC KROŞE 35MM | 300 ad. | | 11,30 |
| 001 048 070009 00 00 | NO. 9 ÇİFTLİ GALVANİZ SAC KROŞE 45MM | 200 ad. | | 13,50 |
| 001 048 070010 00 00 | NO. 10 ÇİFTLİ GALVANİZ SAC KROŞE 50MM | 150 ad. | | 14,30 |
| 001 048 070011 00 00 | NO. 11 ÇİFTLİ GALVANİZ SAC KROŞE 55MM | 100 ad. | | 15,10 |

BORU GEÇME TOPRAKLAMA ÇUBUĞU

| | | | | |
|----------------|--------------------------------------|--------|--|----------|
| 091 025 011610 | TOP ÇUBUĞU BORU GEÇMELİ 16 MM 1 MT | 10 ad. | | 665,50 |
| 091 025 011615 | TOP ÇUBUĞU BORU GEÇMELİ 16 MM 1,5 MT | 10 ad. | | 961,28 |
| 091 025 012010 | TOP ÇUBUĞU BORU GEÇMELİ 20 MM 1 MT | 5 ad. | | 961,28 |
| 091 025 012015 | TOP ÇUBUĞU BORU GEÇMELİ 20 MM 1,5 MT | 5 ad. | | 1.404,94 |

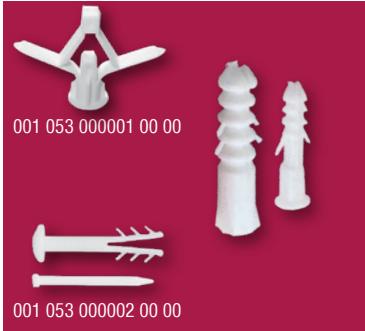

001 053 000001 00 00

001 053 000002 00 00



16 053 000014

| Ürün Kodu | Ürün Adı | Kutu Mt./Ad. | Koli Adet | Fiyat (₺) |
|-------------------------------------|--------------------------------|--------------|-----------|-----------|
| RAY KROŞE VE TANDIR KROŞELER | | | | |
| 035 048 100001 | NO. 1 RAY KROŞE (2X1.5-4X2.5) | 350 ad. | | 9,40 |
| 035 048 100002 | NO. 2 RAY KROŞE (4X4-4X16) | 250 ad. | | 10,30 |
| 001 025 010100 00 00 | GALVANİZ KROŞE RAYI (1M) | 50 ad. | | 89,20 |
| 035 048 110001 | NO. 1 TANDIR KROŞE (2X1.5-2X6) | 350 ad. | | 9,40 |
| 035 048 110002 | NO. 2 TANDIR KROŞE (4X6) | 250 ad. | | 9,40 |
| 035 048 110003 | NO. 3 TANDIR KROŞE (4X10) | 250 ad. | | 9,40 |
| 035 048 110004 | NO. 4 TANDIR KROŞE (4X16) | 150 ad. | | 12,20 |
| 035 048 110005 | NO. 5 TANDIR KROŞE (3X25+16) | 150 ad. | | 12,20 |
| PLASTİK DÜBELLER | | | | |
| 016 053 000014 | BURGULU ALÇIPAN DÜBELİ (YENİ) | 100 ad. | 10000 | 1,03 |
| 001 053 000001 00 00 | ALÇIPAN DÜBEL | 100 ad. | 15000 | 0,74 |
| 001 053 000002 00 00 | KANAL DÜBELİ | 1000 ad. | 14000 | 0,65 |
| 016 053 000006 | 6 MM BEYAZ DÜBEL | 1000 ad. | 35000 | 0,23 |
| 016 053 000007 | 7 MM BEYAZ DÜBEL | 1000 ad. | 25000 | 0,25 |
| 016 053 000008 | 8 MM BEYAZ DÜBEL | 1000 ad. | 20000 | 0,30 |

DÜBELİ KROŞELER

| | | | | |
|----------------------|-------------------------------|---------|-------|------|
| 001 048 090002 00 17 | 3/13 TEKLİ KABLO KROŞESİ | 500 ad. | 10000 | 0,82 |
| 001 048 090006 00 17 | 8/28 TEKLİ KABLO KROŞESİ | 500 ad. | 5000 | 0,93 |
| 001 048 090001 00 00 | ÇİFTLİ KABLO KROŞESİ (20'LİK) | 100 ad. | 8000 | 1,31 |
| 001 048 090002 00 00 | ÇİFTLİ KABLO KROŞESİ (25'LİK) | 250 ad. | 5000 | 1,36 |
| 001 048 090003 00 17 | 16'LİK BORU KELEPÇESİ | 100 ad. | 2000 | 0,97 |
| 001 048 090004 00 17 | 20'LİK BORU KELEPÇESİ | 100 ad. | 1500 | 1,74 |
| 001 048 090005 00 17 | 25'LİK BORU KELEPÇESİ | 100 ad. | 1000 | 2,43 |

KABLOLARINIZ EMİN ELLEERDE



YENİ



ELEKTRİK İZOLASYON BANDI

Sizin Güvenliğiniz; Bizim Önceliğimiz!



ELEKTRİK İZOLASYON BANTLARI 0.13mm x 19mm x 10yds (9,14m)



| Ürün Kodu | Ürün Adı | Paket Ad. | Koli Ad. | Fiyat (₺) |
|----------------|---|-----------|----------|-----------|
| 065 133 001019 | PVC ELEKTRİK İZOLE BANDI - SİYAH | 10 | 500 | 19,31 |
| 065 133 011019 | PVC ELEKTRİK İZOLE BANDI - BEYAZ | 10 | 500 | 19,31 |
| 065 133 161019 | PVC ELEKTRİK İZOLE BANDI - KIRMIZI | 10 | 500 | 19,31 |
| 065 133 131019 | PVC ELEKTRİK İZOLE BANDI - MAVİ | 10 | 500 | 19,31 |
| 065 133 141019 | PVC ELEKTRİK İZOLE BANDI - SARI | 10 | 500 | 19,31 |
| 065 133 151019 | PVC ELEKTRİK İZOLE BANDI - YEŞİL | 10 | 500 | 19,31 |
| 065 133 171019 | PVC ELEKTRİK İZOLE BANDI - SARI + YEŞİL | 10 | 500 | 21,23 |

| Ürün Kodu | Ürün Adı | Kutu Mt./Ad. | Koli Adet | Fiyat (₺) |
|---|---|--------------|-----------|-----------|
| AKILLI KAPI KİLİDİ | | | | |
| 027 112 000010 | AKILLI KAPI KİLİDİ | 1 ad. | | 3.654,44 |
| 027 112 000012 | KAPI KONTROL SİSTEMİ 1000 HAFIZALI KARTLI METAL GÖVDE | 1 ad. | | 2.951,67 |
| KAPI VE MERDİVEN OTOMATIĞI | | | | |
| 027 112 000001 | GİZLİ KAPI OTOMATIĞI (DOKUNMATİK) | 1 ad. | 20 | 1.030,74 |
| 027 112 000002 | GİZLİ KAPI OTOMATIĞI (BASMATİK) | 1 ad. | 20 | 1.030,74 |
| 027 112 000007 | ELEK. KİLİTLİ (ANAHTARLI) KAPI OTOMATIĞI | 1 ad. | 12 | 2.038,06 |
| 027 112 000009 | ELEKTRİKLİ KİLİTLİ KAPI OTOMATIĞI (BİLYELİ) | 1 ad. | 12 | 2.038,06 |
| 027 112 000003 | BUTONLU KAPI OTOMATIĞI | 1 ad. | 30 | 796,48 |
| 028 112 000004 | KAPI OTOMATIĞI (NORMAL) | 1 ad. | 30 | 773,06 |
| 027 112 000004 | BAS-AÇ KAPI OTOMATIĞI (TİRAJLI KİLİT İÇİN) | 1 ad. | | 1.218,15 |
| 027 112 000005 | MERDİVEN OTOMATIĞI (RAYLI) | 1 ad. | 30 | 796,48 |
| 027 112 000006 | MERDİVEN OTOMATIĞI (NORMAL) | 1 ad. | 30 | 796,48 |
| ZİL BUTONU ÇEŞİTLERİ | | | | |
| 037 106 020001 | 1'Lİ ALÜMİNYUM ZİL BUTONU 1.KALİTE | 1 ad. | 100 | 81,99 |
| 037 106 020002 | 2'Lİ ALÜMİNYUM ZİL BUTONU 1.KALİTE | 1 ad. | 66 | 163,98 |
| 037 106 020003 | 3'LÜ ALÜMİNYUM ZİL BUTONU 1.KALİTE | 1 ad. | 56 | 245,97 |
| 037 106 020004 | 4'LÜ ALÜMİNYUM ZİL BUTONU 1.KALİTE | 1 ad. | 43 | 327,96 |
| 037 106 020005 | 5'Lİ ALÜMİNYUM ZİL BUTONU 1.KALİTE | 1 ad. | 36 | 409,95 |
| 037 106 020006 | 6'Lİ ALÜMİNYUM ZİL BUTONU 1.KALİTE | 1 ad. | 32 | 491,94 |
| 037 106 020007 | 7'Lİ ALÜMİNYUM ZİL BUTONU 1.KALİTE | 1 ad. | 28 | 573,94 |
| 037 106 020008 | 8'Lİ ALÜMİNYUM ZİL BUTONU 1.KALİTE | 1 ad. | 20 | 655,93 |
| 037 106 020009 | 9'LU ALÜMİNYUM ZİL BUTONU 1.KALİTE | 1 ad. | 20 | 737,92 |
| 037 106 020010 | 10'LU ALÜMİNYUM ZİL BUTONU 1.KALİTE | 1 ad. | 20 | 819,91 |
| ZİLLER VE ZİL TRAFOLARI | | | | |
| 027 105 010012 | ZİL TRAFOSU 12 V | 1 ad. | 80 | 281,11 |
| 027 105 010015 | ZİL TRAFOSU 15 V | 1 ad. | 40 | 515,37 |
| 028 105 020003 | KAMPANA ZİL 220 V | 1 ad. | 24 | 1.265,00 |
| 028 105 020004 | KAMPANA ZİL 12V, 24V, 110V | 1 ad. | 24 | 1.855,33 |
| 028 105 020000 | MUNZAM ZİL ROLESİ | 1 ad. | 100 | 843,33 |
| 018 105 000006 | KANARYA ZİL (TEK SES) | 1 ad. | 50 | 156,95 |
| 018 105 000007 | KANARYA ZİL (ÜÇ SES) | 1 ad. | 50 | 182,72 |
| 018 105 000001 | TELEFON ZİLİ (AYARLI) | 1 ad. | 50 | 257,69 |
| 018 105 000002 | DİNG DONG ZİL ELEKTRONİK (3 SES) | 1 ad. | 50 | 182,72 |
| TELEFON DAĞITIM KUTULARI ve AKSESUARLARI | | | | |
| 001 049 001020 00 17 | TLF. DĞT. KUTUSU (10 - 20) BOŞ PLS. KLT | 2 ad. | 60 | 328,75 |
| 001 049 201020 00 17 | TLF.DĞT.KUTUSU(10-20)BOŞ PLS.(KİLİTLİ) (A. YAYMAYAN) | 2 ad. | 60 | 418,61 |
| 001 049 011020 00 17 | TLF. DĞT. KUTUSU (10 - 20) BOŞ KİLİTLİ | 2 ad. | 60 | 468,42 |
| 001 049 211020 00 17 | TLF.DĞT.KUTUSU(10-20)BOŞ(KİLİTLİ) (A. YAYMAYAN) | 2 ad. | 60 | 557,96 |
| 001 049 001050 00 17 | TLF. DĞT. KUTUSU(10-50) BOŞ PLS.KİLİT | 1 ad. | 28 | 481,48 |
| 001 049 201050 00 17 | TLF.DĞT.KUTUSU(10-50)BOŞ PLS.(KİLİTLİ) (A. YAYMAYAN) | 1 ad. | 28 | 695,88 |
| 001 049 011050 00 17 | TLF. DĞT. KUTUSU(10-50) KİLİTLİ | 1 ad. | 28 | 634,35 |
| 001 049 211050 00 17 | TLF.DĞT.KUTUSU(10-50)(KİLİTLİ) (A. YAYMAYAN) | 1 ad. | 28 | 766,67 |
| 001 024 000001 00 00 | ÇATI (1 MODÜL İÇİN) | 1 ad. | 1000 | 27,21 |
| 001 024 000002 00 00 | ÇATI (2 MODÜL İÇİN) | 1 ad. | 500 | 54,42 |
| 001 024 000003 00 00 | ÇATI (3 MODÜL İÇİN) | 1 ad. | 400 | 81,63 |
| 001 024 000004 00 00 | ÇATI (4 MODÜL İÇİN) | 1 ad. | 300 | 108,85 |
| 001 024 000005 00 00 | ÇATI (5 MODÜL İÇİN) | 1 ad. | 200 | 136,06 |
| 001 024 000010 00 00 | ÇATI (10 MODÜL İÇİN) | 1 ad. | 100 | 272,12 |
| 888 049 050001 | KESMESİZ MODÜL | 10 ad. | 250 | 5,48 \$ |
| 888 049 050002 | KESMELİ MODÜL | 10 ad. | 250 | 6,58 \$ |
| 888 049 050003 | İRTİBATLAMA ALETİ | 1 ad. | 50 | 16,44 \$ |





| | |
|---------------|---|
| ÜRÜN KODU | 888 038 218000 |
| ÜRÜN ADI | Q218 KABLOSUZ KAPI ZİLİ LEDLİ 100 MT. - 32 MELODİ |
| AMB. AD./KOLİ | 1 Ad. / 10 |
| FİYAT | 42,63 \$ |



| | |
|---------------|-----------------------------|
| ÜRÜN KODU | 018 105 114800 |
| ÜRÜN ADI | A-148 KAPI ZİLİ - 32 MELODİ |
| AMB. AD./KOLİ | 1 Ad. / 10 |
| FİYAT | 27,33 \$ |



| | |
|---------------|-----------------------------|
| ÜRÜN KODU | 018 105 158100 |
| ÜRÜN ADI | X-581 KAPI ZİLİ - 32 MELODİ |
| AMB. AD./KOLİ | 1 Ad. / 10 |
| FİYAT | 28,26 \$ |



| | |
|---------------|------------------------------------|
| ÜRÜN KODU | 018 105 162811 |
| ÜRÜN ADI | WA-628 KAPI ZİLİ - SİYAH 32 MELODİ |
| AMB. AD./KOLİ | 1/10 |
| FİYAT | 36,01 \$ |



| | |
|---------------|----------------------------------|
| ÜRÜN KODU | 018 105 162800 |
| ÜRÜN ADI | WA-628 KAPI ZİLİ BEYAZ 32 MELODİ |
| AMB. AD./KOLİ | 1 Ad. / 10 |
| FİYAT | 36,01 \$ |



| | |
|---------------|------------------------------------|
| ÜRÜN KODU | 018 105 163811 |
| ÜRÜN ADI | WA-638 KAPI ZİLİ - SİYAH 32 MELODİ |
| AMB. AD./KOLİ | 1 Ad. / 10 |
| FİYAT | 36,02 \$ |



| | |
|---------------|----------------------------------|
| ÜRÜN KODU | 018 105 163800 |
| ÜRÜN ADI | WA-638 KAPI ZİLİ BEYAZ 32 MELODİ |
| AMB. AD./KOLİ | 1 Ad. / 10 |
| FİYAT | 36,02 \$ |



028 120 00001



888 111 050004



026 112 010001



028 120 010005



028 120 010006



026 111 010003



010 090 050051



102 111 000221



102 111 00220

| Kod | Ürün Adı | Kutu Mt./Ad. | Koli Adet | Fiyat (₺) | |
|---|---|--------------|-----------|-----------|-----------|
| İKAZ KORNASI | | CE | | | |
| 026 112 010001 | İKAZ KORNASI 220 V | 1 ad. | 45 | 531,77 | |
| 028 120 000001 | İKAZ BUTONU (KARE) | 2 ad. | 90 | 154,61 | |
| ALARM KORNA ve YANGIN İHBAR BUTONU | | CE | | | |
| 010 090 050050 | RESETFLENEBİLİR BUTON | 2 ad. | 90 | 796,48 | |
| 010 090 050051 | RESETFLENEBİLİR BUTON (KAPAKLI) | 1 ad. | 90 | 890,19 | |
| 028 120 010006 | ALARM KORNA PLASTİK | 1 ad. | 30 | 796,48 | |
| 028 120 010005 | ALARM KORNA DÖKÜM | 1 ad. | 30 | 913,61 | |
| SİRENLER | | | | | |
| 102 111 000012 | LEDLİ FLAŞÖRLÜ ELEKTRONİK SİREN 12V | 1 ad. | 25 | 438,10 | |
| 102 111 000024 | LEDLİ FLAŞÖRLÜ ELEKTRONİK SİREN 24V | 1 ad. | 25 | 438,10 | |
| 102 111 000220 | LEDLİ FLAŞÖRLÜ ELEKTRONİK SİREN 220V | 1 ad. | 25 | 456,80 | |
| 102 111 000221 | LEDLİ FLAŞÖRLÜ ELEKTRONİK SİREN 220V. (YENİ MODEL) | 1 ad. | 30 | 655,90 | |
| 888 111 050004 | MS190 MİNİ SİREN (105 db) | 1 ad. | 40 | 15,30 \$ | |
| 026 111 010001 | AS. 1 MOTORLU SİREN (PLS. GÖV.)220V,100W (110 db.) | 1 ad. | 20 | 1.686,67 | |
| 026 111 010002 | AS. 2 MOTORLU SİREN (PLS.GÖV.)220V,100W (117 db.) | 1 ad. | 12 | 1.874,07 | |
| 026 111 010003 | AS. 1 MOTORLU SİREN (METAL.GÖV.)220V,100W (115 db.) | CE | 1 ad. | 20 | 2.108,33 |
| 026 111 010004 | AS. 2 MOTORLU SİREN (METAL.GÖV.)220V,100W (120 db.) | CE | 1 ad. | 12 | 2.553,43 |
| 026 111 010005 | AS.3 MOTORLU SİREN 220V-280W (130 db.) | CE | 1 ad. | - | 15.226,90 |



ME-FAN ASPİRATÖR ÇEŞİTLERİ

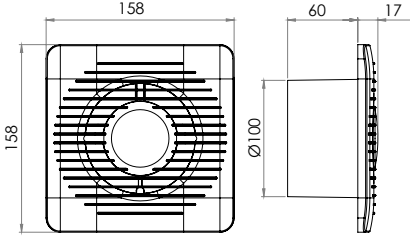

100 mm



| | |
|------------------------------------|--------------------|
| Çalışma Akımı Operation Voltage | 220-240V / 50-60Hz |
| Emiş Hacmi Airflow | 100m³/h |
| Devir Hızı Round Speed | 2450 rpm |
| Ses Voice | 43 dB |
| Güç Power | 12W |

| | |
|---------------------|---------------------------------|
| ÜRÜN KODU | : 001 211 000100 00 00 |
| ÜRÜN ADI | : MUTLUSAN ME-FAN 100 ASPİRATÖR |
| AMBALAJ ADET / KOLİ | : 1 / 20 |
| FİYAT (₺) | : 403,30 ₺ |

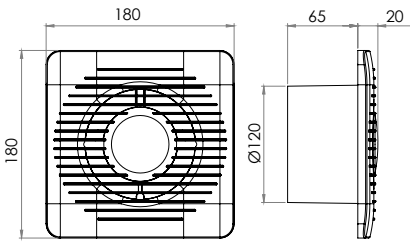

120 mm



| | |
|------------------------------------|--------------------|
| Çalışma Akımı Operation Voltage | 220-240V / 50-60Hz |
| Emiş Hacmi Airflow | 120m³/h |
| Devir Hızı Round Speed | 1900 rpm |
| Ses Voice | 47 dB |
| Güç Power | 15W |

| | |
|---------------------|---------------------------------|
| ÜRÜN KODU | : 001 211 000120 00 00 |
| ÜRÜN ADI | : MUTLUSAN ME-FAN 120 ASPİRATÖR |
| AMBALAJ ADET / KOLİ | : 1 / 20 |
| FİYAT (₺) | : 425,70 ₺ |

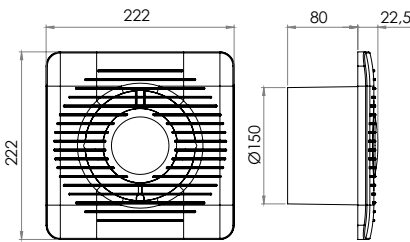

150 mm



| | |
|------------------------------------|--------------------|
| Çalışma Akımı Operation Voltage | 220-240V / 50-60Hz |
| Emiş Hacmi Airflow | 150m³/h |
| Devir Hızı Round Speed | 1350 rpm |
| Ses Voice | 47 dB |
| Güç Power | 20W |

| | |
|---------------------|---------------------------------|
| ÜRÜN KODU | : 001 211 000150 00 00 |
| ÜRÜN ADI | : MUTLUSAN ME-FAN 150 ASPİRATÖR |
| AMBALAJ ADET / KOLİ | : 1 / 12 |
| FİYAT (₺) | : 627,40 ₺ |

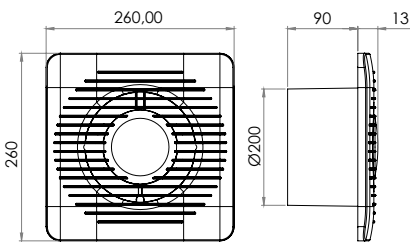

200 mm

| | |
|------------------------------------|--------------------|
| Çalışma Akımı Operation Voltage | 220-240V / 50-60Hz |
| Emiş Hacmi Airflow | 200m³/h |
| Devir Hızı Round Speed | 1200 rpm |
| Ses Voice | 55 dB |
| Güç Power | 40W |

| | |
|---------------------|---------------------------------|
| ÜRÜN KODU | : 001 211 000200 00 00 |
| ÜRÜN ADI | : MUTLUSAN ME-FAN 200 ASPİRATÖR |
| AMBALAJ ADET / KOLİ | : 1 / 6 |
| FİYAT (₺) | : 1.171,30 ₺ |



MUTLUSAN ASPİRATÖR ÇEŞİTLERİ



100 mm



| | |
|------------------------------------|----------------------|
| Çalışma Akımı Operation Voltage | 220-240V / 50-60Hz |
| Emiş Hacmi Airflow | 100m ³ /h |
| Devir Hızı Round Speed | 2450 rpm |
| Ses Voice | 43 dB |
| Güç Power | 12W |

ÜRÜN KODU : 001 111 000100 00 00
ÜRÜN ADI : MUTLUSAN 100 ASPİRATÖR
AMBALAJ ADET / KOLİ : 1 / 20
FİYAT (₺) : 439,70 ₺

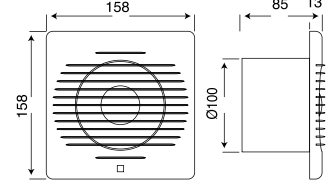

120 mm



| | |
|------------------------------------|----------------------|
| Çalışma Akımı Operation Voltage | 220-240V / 50-60Hz |
| Emiş Hacmi Airflow | 120m ³ /h |
| Devir Hızı Round Speed | 1900 rpm |
| Ses Voice | 47 dB |
| Güç Power | 15W |

ÜRÜN KODU : 001 111 000120 00 00
ÜRÜN ADI : MUTLUSAN 120 ASPİRATÖR
AMBALAJ ADET / KOLİ : 1 / 20
FİYAT (₺) : 458,90 ₺

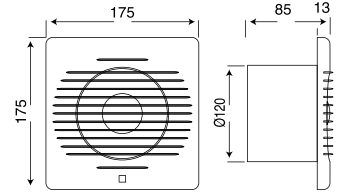

150 mm



| | |
|------------------------------------|----------------------|
| Çalışma Akımı Operation Voltage | 220-240V / 50-60Hz |
| Emiş Hacmi Airflow | 150m ³ /h |
| Devir Hızı Round Speed | 1350 rpm |
| Ses Voice | 47 dB |
| Güç Power | 20W |

ÜRÜN KODU : 001 111 000150 00 00
ÜRÜN ADI : MUTLUSAN 150 ASPİRATÖR
AMBALAJ ADET / KOLİ : 1 / 16
FİYAT (₺) : 679,00 ₺

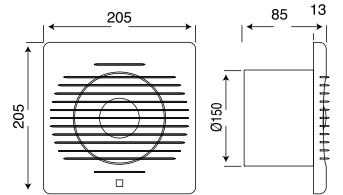

200 mm



| | |
|------------------------------------|----------------------|
| Çalışma Akımı Operation Voltage | 220-240V / 50-60Hz |
| Emiş Hacmi Airflow | 200m ³ /h |
| Devir Hızı Round Speed | 1000 rpm |
| Ses Voice | 47 dB |
| Güç Power | 20W |

ÜRÜN KODU : 001 111 000200 00 00
ÜRÜN ADI : MUTLUSAN 200 ASPİRATÖR
AMBALAJ ADET / KOLİ : 1 / 6
FİYAT (₺) : 1.276,60 ₺

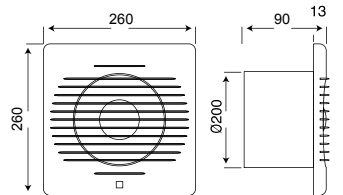

LED ARMATÜR ÇEŞİTLERİ



| | | |
|---------------|-----------------------|----------------|
| RENK | BEYAZ | SİYAH |
| ÜRÜN KODU | 016 038 701500 | 016 038 701511 |
| ÜRÜN ADI | LED GLOP ARMATÜR IP20 | |
| LÜMEN/WATT | 2000Lm/20W | |
| KELVIN | 6400K | |
| AMB. AD./KOLİ | 24 | |
| FİYAT (₺) | 445,10 | |

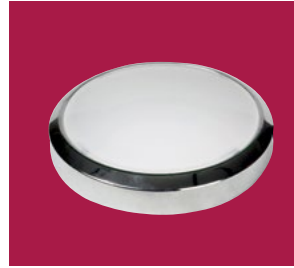

| | | |
|---------------|------------------------------|--|
| ÜRÜN KODU | 016 038 701522 | |
| ÜRÜN ADI | LED GLOP ARMATÜR KROM - IP20 | |
| LÜMEN/WATT | 2000Lm/20W | |
| KELVIN | 6400K | |
| AMB. AD./KOLİ | 24 | |
| FİYAT (₺) | 538,80 | |



| | | |
|---------------|------------------------------------|--|
| ÜRÜN KODU | 016 038 701700 | |
| ÜRÜN ADI | 18W NEMLİYER LED OVAL ARM. - BEYAZ | |
| LÜMEN/WATT | 1900Lm/18W | |
| KELVIN | 6400K - 3400K | |
| AMB. AD./KOLİ | 1/40 | |
| FİYAT (₺) | 445,10 | |



| | | |
|---------------|------------------------------------|--|
| ÜRÜN KODU | 016 038 701600 | |
| ÜRÜN ADI | 22W NEMLİYER LED GLOP ARM. - BEYAZ | |
| LÜMEN/WATT | 2340Lm/22W | |
| KELVIN | 6400K - 3400K | |
| AMB. AD./KOLİ | 1/40 | |
| FİYAT (₺) | 445,10 | |



| | | |
|------------|-----------------------|----------------|
| RENK | BEYAZ | SİYAH |
| ÜRÜN KODU | 016 038 701100 | 016 038 701111 |
| ÜRÜN ADI | LEDLIGHT-1 LEDLİ ARM. | |
| LÜMEN/WATT | 1500Lm/15W | |
| KELVIN | 6400K | |
| KUTU ADEDİ | 30 | |
| FİYAT (₺) | 236,70 | |



| | | |
|------------|-----------------------|----------------|
| RENK | BEYAZ | SİYAH |
| ÜRÜN KODU | 016 038 701200 | 016 038 701211 |
| ÜRÜN ADI | LEDLIGHT-2 LEDLİ ARM. | |
| LÜMEN/WATT | 2000Lm/20W | |
| KELVIN | 6400K | |
| KUTU ADEDİ | 20 | |
| FİYAT (₺) | 320,20 | |

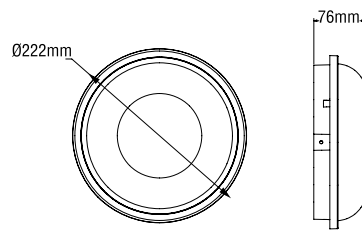
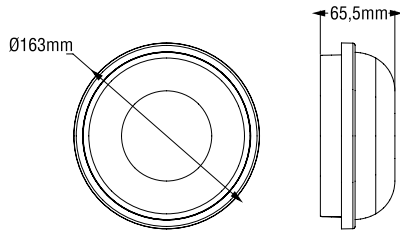

| | | |
|------------|-----------------------|----------------|
| RENK | BEYAZ | SİYAH |
| ÜRÜN KODU | 016 038 701300 | 016 038 701311 |
| ÜRÜN ADI | LEDLIGHT-3 LEDLİ ARM. | |
| LÜMEN/WATT | 1500Lm/15W | |
| KELVIN | 6400K | |
| KUTU ADEDİ | 30 | |
| FİYAT (₺) | 236,70 | |



| | | |
|------------|-----------------------|----------------|
| RENK | BEYAZ | SİYAH |
| ÜRÜN KODU | 016 038 701400 | 016 038 701411 |
| ÜRÜN ADI | LEDLIGHT-4 LEDLİ ARM. | |
| LÜMEN/WATT | 2000Lm/20W | |
| KELVIN | 6400K | |
| KUTU ADEDİ | 20 | |
| FİYAT (₺) | 320,20 | |

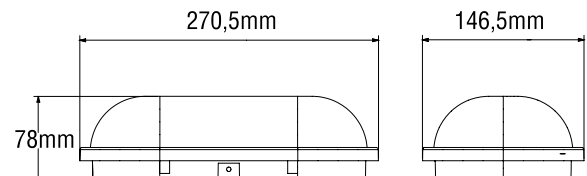
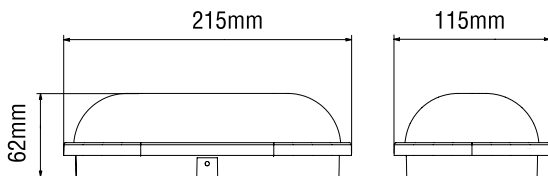

ARMATÜR ÇEŞİTLERİ



| | |
|---------------|---|
| ÜRÜN KODU | 001 038 250021 00 00 |
| ÜRÜN ADI | 360° SENSÖRLÜ TAVAN ARM. ACİL KİTLİ (2x25W) (PİL DAHİL) |
| AMB. AD./KOLİ | 1/12 |
| FİYAT (₺) | 1.101,00 |



| | |
|---------------|--------------------------------------|
| ÜRÜN KODU | 001 038 250022 00 00 |
| ÜRÜN ADI | 360° SENSÖRLÜ TAVAN ARMATÜRÜ (2x25W) |
| AMB. AD./KOLİ | 1/12 |
| FİYAT (₺) | 538,80 |



| | |
|---------------|--|
| ÜRÜN KODU | 001 038 250052 00 00 |
| ÜRÜN ADI | 360° SENSÖRLÜ TAVAN ARM. (2x25W) (TSE) |
| AMB. AD./KOLİ | 1/12 |
| FİYAT (₺) | 808,20 |



| | |
|---------------|-----------------------|
| ÜRÜN KODU | 001 038 180101 00 00 |
| ÜRÜN ADI | AKASYA TAVAN ARMATÜRÜ |
| AMB. AD./KOLİ | 1/5 |
| FİYAT (₺) | 273,10 |



| | |
|---------------|-----------------------------------|
| ÜRÜN KODU | 001 038 250026 00 00 |
| ÜRÜN ADI | SENSÖRLÜ GLOP ARMATÜRÜ 2XE27 PLS. |
| AMB. AD./KOLİ | 1/12 |
| FİYAT (₺) | 491,90 |



| | |
|---------------|-----------------------------------|
| ÜRÜN KODU | 001 038 250027 00 00 |
| ÜRÜN ADI | SENSÖRLÜ GLOP ARMATÜRÜ LEDLİ PLS. |
| AMB. AD./KOLİ | 1/12 |
| FİYAT (₺) | 632,50 |



| | |
|---------------|-----------------------------|
| ÜRÜN KODU | 016 038 250085 |
| ÜRÜN ADI | ÇINAR DUVAR APLİK PLS, SOFT |
| AMB. AD./KOLİ | 1/24 |
| FİYAT (₺) | 515,40 |



| | |
|---------------|---------------------------------|
| ÜRÜN KODU | 078 039 500100 |
| ÜRÜN ADI | SENSÖRLÜ DUVAR APLİK E-27 DUYLU |
| AMB. AD./KOLİ | 1/20 |
| FİYAT (₺) | 609,10 |



| | |
|---------------|----------------------------|
| ÜRÜN KODU | 016 038 250086 |
| ÜRÜN ADI | İNCİ TAVAN ARMATÜR - BEYAZ |
| AMB. AD./KOLİ | 4/32 |
| FİYAT (₺) | 192,10 |



| | |
|---------------|----------------------------|
| ÜRÜN KODU | 016 038 250087 |
| ÜRÜN ADI | İNCİ TAVAN ARMATÜR - CEVİZ |
| AMB. AD./KOLİ | 4/32 |
| FİYAT (₺) | 224,90 |



| | |
|---------------|-----------------------|
| ÜRÜN KODU | 001 038 010101 00 00 |
| ÜRÜN ADI | MANOLYA TAVAN ARMATÜR |
| AMB. AD./KOLİ | 1/5 |
| FİYAT (₺) | 267,30 |

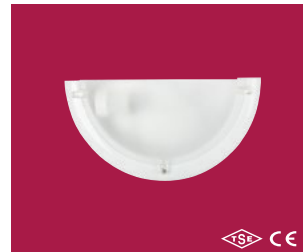

| | |
|---------------|----------------------|
| ÜRÜN KODU | 001 038 010201 00 00 |
| ÜRÜN ADI | MANOLYA DUVAR APLİK |
| AMB. AD./KOLİ | 2/20 |
| FİYAT (₺) | 165,90 |



| | |
|---------------|----------------------|
| ÜRÜN KODU | 001 038 020101 00 00 |
| ÜRÜN ADI | FULYA TAVAN ARMATÜRÜ |
| AMB. AD./KOLİ | 1/5 |
| FİYAT (₺) | 276,70 |



| | |
|---------------|----------------------|
| ÜRÜN KODU | 001 038 020201 00 00 |
| ÜRÜN ADI | FULYA DUVAR APLİK |
| AMB. AD./KOLİ | 2/20 |
| FİYAT (₺) | 152,90 |

ARMATÜR ÇEŞİTLERİ

| | | |
|---|---------------|-------------------------------|
|  <p>YENİ</p> | ÜRÜN KODU | 016 038 710017 |
| | ÜRÜN ADI | MİNİ LÜX GLOB ARMATÜR - BEYAZ |
| | AMB. AD./KOLİ | 8/48 |
| | FİYAT (₺) | 128,84 |

| | | |
|---|---------------|-----------------------------|
|  <p>YENİ</p> | ÜRÜN KODU | 016 038 710019 |
| | ÜRÜN ADI | MİNİ LÜX GLOB ARMATÜR - GRİ |
| | AMB. AD./KOLİ | 8/48 |
| | FİYAT (₺) | 128,84 |

| | | |
|--|---------------|-------------------------------|
|  <p>YENİ</p> | ÜRÜN KODU | 016 038 710018 |
| | ÜRÜN ADI | MİNİ LÜX GLOB ARMATÜR - SİYAH |
| | AMB. AD./KOLİ | 8/48 |
| | FİYAT (₺) | 128,84 |

| | | |
|---|---------------|---------------------------|
|  | ÜRÜN KODU | 016 038 250031 |
| | ÜRÜN ADI | TAVAN GLOB ARMATÜR (MİNİ) |
| | AMB. AD./KOLİ | 8/48 |
| | FİYAT (₺) | 155,30 |

| | | |
|---|---------------|-------------------------------|
|  | ÜRÜN KODU | 001 038 250016 00 00 |
| | ÜRÜN ADI | PAPATYA HAZIR ASKI TİJ TAKIMI |
| | AMB. AD./KOLİ | 25/275 |
| | FİYAT (₺) | 51,40 |

| | | |
|---|---------------|-------------------------------------|
|  | ÜRÜN KODU | 001 038 250017 00 00 |
| | ÜRÜN ADI | BÜYÜK PAPATYA HAZIR ASKI TİJ TAKIMI |
| | AMB. AD./KOLİ | 10/80 |
| | FİYAT (₺) | 89,90 |

| | | |
|---|---------------|-----------------------|
|  | ÜRÜN KODU | 001 038 250018 00 00 |
| | ÜRÜN ADI | HAZIR ASKI TİJ TAKIMI |
| | AMB. AD./KOLİ | 25/300 |
| | FİYAT (₺) | 48,90 |

| | | |
|--|---------------|-----------------------|
|  | ÜRÜN KODU | 016 038 250090 |
| | ÜRÜN ADI | YILDIZ TAVAN ARMATÜRÜ |
| | AMB. AD./KOLİ | 8/64 |
| | FİYAT (₺) | 107,60 |

| | | |
|--|---------------|-----------------------|
|  | ÜRÜN KODU | 016 038 250013 |
| | ÜRÜN ADI | DUVAR APLİK (KRALİÇE) |
| | AMB. AD./KOLİ | 4/48 |
| | FİYAT (₺) | 202,50 |

| | | |
|---|---------------|----------------|
|  | ÜRÜN KODU | 078 039 100005 |
| | ÜRÜN ADI | NERGİS APLİK |
| | AMB. AD./KOLİ | 8/64 |
| | FİYAT (₺) | 121,80 |

| | | |
|--|---------------|------------------------------------|
|  | ÜRÜN KODU | 016 038 250089 |
| | ÜRÜN ADI | İNCİ APLİK - DUVAR ARMATÜR - CEVİZ |
| | AMB. AD./KOLİ | 4/64 |
| | FİYAT (₺) | 156,90 |

| | | |
|--|---------------|------------------------------------|
|  | ÜRÜN KODU | 016 038 250088 |
| | ÜRÜN ADI | İNCİ APLİK - DUVAR ARMATÜR - BEYAZ |
| | AMB. AD./KOLİ | 4/64 |
| | FİYAT (₺) | 130,00 |

| | | |
|--|---------------|---------------------------------------|
|  | ÜRÜN KODU | 016 038 250020 |
| | ÜRÜN ADI | HAZIR ASKI TİJ TAKIMI (PLASTİK DUYLU) |
| | AMB. AD./KOLİ | 60 / - |
| | FİYAT (₺) | 44,90 |

| | | |
|--|---------------|---------------------------------|
|  | ÜRÜN KODU | 024 109 010005 |
| | ÜRÜN ADI | YAĞMUR DUY (PLASTİK YANMAZ) E27 |
| | AMB. AD./KOLİ | 50 |
| | FİYAT (₺) | 31,60 |

ARMATÜR ÇEŞİTLERİ



| | | |
|---|---------------|---------------------------------|
|  | ÜRÜN KODU | 016 038 411110 |
| | ÜRÜN ADI | AQUA KAFESLİ APLİK BEYAZ - IP65 |
| | AMB. AD./KOLİ | 1/20 |
| | FİYAT (₺) | 205,60 |

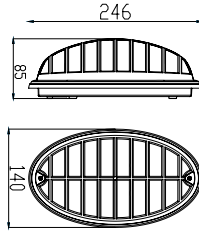

| | | |
|--|---------------|---------------------------------|
|  | ÜRÜN KODU | 016 038 411120 |
| | ÜRÜN ADI | AQUA KAFESLİ APLİK SİYAH - IP65 |
| | AMB. AD./KOLİ | 1/20 |
| | FİYAT (₺) | 205,60 |

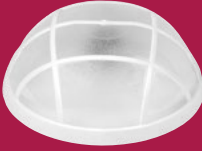
| | | |
|---|---------------|--------------------------------|
|  | ÜRÜN KODU | 016 038 411300 |
| | ÜRÜN ADI | OPAK KAFESLİ ARM. BEYAZ - IP54 |
| | AMB. AD./KOLİ | 1/24 |
| | FİYAT (₺) | 236,80 |

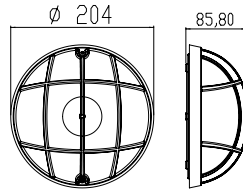

| | | |
|--|---------------|--------------------------------|
|  | ÜRÜN KODU | 016 038 411311 |
| | ÜRÜN ADI | OPAK KAFESLİ ARM. SİYAH - IP54 |
| | AMB. AD./KOLİ | 1/24 |
| | FİYAT (₺) | 236,80 |

| | | |
|--|---------------|------------------------------|
|  | ÜRÜN KODU | 016 038 410600 |
| | ÜRÜN ADI | ELİPS OPAL ARM. BEYAZ - IP65 |
| | AMB. AD./KOLİ | 1/10 |
| | FİYAT (₺) | 425,60 |

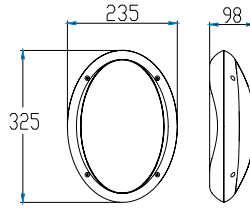

| | | |
|---|---------------|------------------------------|
|  | ÜRÜN KODU | 016 038 410611 |
| | ÜRÜN ADI | ELİPS OPAL ARM. SİYAH - IP65 |
| | AMB. AD./KOLİ | 1/10 |
| | FİYAT (₺) | 425,60 |

| | | |
|---|---------------|---------------------------|
|  | ÜRÜN KODU | 016 038 410500 |
| | ÜRÜN ADI | OPAL ARMATÜR BEYAZ - IP65 |
| | AMB. AD./KOLİ | 1/10 |
| | FİYAT (₺) | 412,80 |

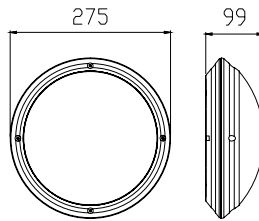

| | | |
|--|---------------|---------------------------|
|  | ÜRÜN KODU | 016 038 410511 |
| | ÜRÜN ADI | OPAL ARMATÜR SİYAH - IP65 |
| | AMB. AD./KOLİ | 1/10 |
| | FİYAT (₺) | 412,80 |

| | | |
|---|---------------|---------------------------|
|  | ÜRÜN KODU | 016 038 410800 |
| | ÜRÜN ADI | OPAK ARMATÜR BEYAZ - IP65 |
| | AMB. AD./KOLİ | 1/16 |
| | FİYAT (₺) | 281,20 |

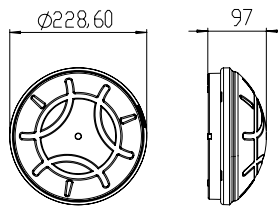

| | | |
|--|---------------|---------------------------|
|  | ÜRÜN KODU | 016 038 410811 |
| | ÜRÜN ADI | OPAK ARMATÜR SİYAH - IP65 |
| | AMB. AD./KOLİ | 1/16 |
| | FİYAT (₺) | 281,20 |

| | | |
|---|---------------|--------------------------------|
|  | ÜRÜN KODU | 016 038 700100 |
| | ÜRÜN ADI | DOLUNAY OPAK ARM. BEYAZ - IP54 |
| | AMB. AD./KOLİ | 1/16 |
| | FİYAT (₺) | 279,10 |

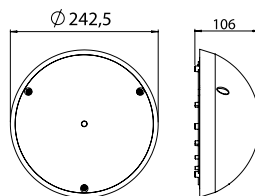

| | | |
|--|---------------|--------------------------------|
|  | ÜRÜN KODU | 016 038 700111 |
| | ÜRÜN ADI | DOLUNAY OPAK ARM. SİYAH - IP54 |
| | AMB. AD./KOLİ | 1/16 |
| | FİYAT (₺) | 279,10 |

ARMATÜR ÇEŞİTLERİ

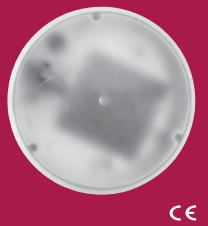

| | | |
|---|---------------|----------------------------------|
|  | ÜRÜN KODU | 016 038 700200 |
| | ÜRÜN ADI | DOLUNAY ŞEFFAF ARM. BEYAZ - IP54 |
| | AMB. AD./KOLİ | 1/16 |
| | FİYAT (₺) | 279,10 |

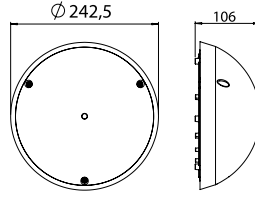

| | | |
|--|---------------|----------------------------------|
|  | ÜRÜN KODU | 016 038 700211 |
| | ÜRÜN ADI | DOLUNAY ŞEFFAF ARM. SİYAH - IP54 |
| | AMB. AD./KOLİ | 1/16 |
| | FİYAT (₺) | 279,10 |

| | | |
|---|---------------|---------------------------------|
|  | ÜRÜN KODU | 016 038 700300 |
| | ÜRÜN ADI | DOLUNAY OPAK APLİK BEYAZ - IP54 |
| | AMB. AD./KOLİ | 1/20 |
| | FİYAT (₺) | 258,00 |

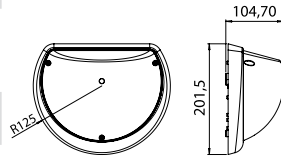

| | | |
|--|---------------|---------------------------------|
|  | ÜRÜN KODU | 016 038 700311 |
| | ÜRÜN ADI | DOLUNAY OPAK APLİK SİYAH - IP54 |
| | AMB. AD./KOLİ | 1/20 |
| | FİYAT (₺) | 258,00 |

| | | |
|--|---------------|-----------------------------------|
|  | ÜRÜN KODU | 016 038 700400 |
| | ÜRÜN ADI | DOLUNAY ŞEFFAF APLİK BEYAZ - IP54 |
| | AMB. AD./KOLİ | 1/20 |
| | FİYAT (₺) | 258,00 |

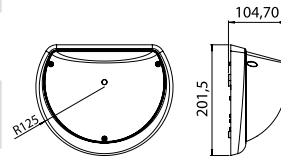

| | | |
|---|---------------|-----------------------------------|
|  | ÜRÜN KODU | 016 038 700411 |
| | ÜRÜN ADI | DOLUNAY ŞEFFAF APLİK SİYAH - IP54 |
| | AMB. AD./KOLİ | 1/20 |
| | FİYAT (₺) | 258,00 |

| | | |
|---|---------------|---|
|  | ÜRÜN KODU | 001 038 150101 00 00 |
| | ÜRÜN ADI | BEGONYA NEMLİYER TAVAN ARMATÜRÜ KLASİK - IP54 |
| | AMB. AD./KOLİ | 12 |
| | FİYAT (₺) | 392,80 |

| | | |
|--|---------------|--------------------------------|
|  | ÜRÜN KODU | 078 039 100006 |
| | ÜRÜN ADI | ÇİFT DUYLU TAVAN ARMATÜR -IP20 |
| | AMB. AD./KOLİ | 2/32 |
| | FİYAT (₺) | 224,90 |

| | | |
|---|---------------|--|
|  | ÜRÜN KODU | 001 038 140101 00 00 |
| | ÜRÜN ADI | BEGONYA NEMLİYER TAVAN ARMATÜRÜ YATAY - IP54 |
| | AMB. AD./KOLİ | 12 |
| | FİYAT (₺) | 392,80 |

| | | |
|--|---------------|--|
|  | ÜRÜN KODU | 001 038 130101 00 00 |
| | ÜRÜN ADI | BEGONYA NEMLİYER TAVAN ARMATÜRÜ DİKEY - IP54 |
| | AMB. AD./KOLİ | 12 |
| | FİYAT (₺) | 392,80 |

| | | |
|---|---------------|-------------------------|
|  | ÜRÜN KODU | 016 038 250028 |
| | ÜRÜN ADI | OVAL DÜZ ARMATÜR - IP20 |
| | AMB. AD./KOLİ | 8/48 |
| | FİYAT (₺) | 254,00 |

| | | |
|--|---------------|-----------------------------|
|  | ÜRÜN KODU | 016 038 250029 |
| | ÜRÜN ADI | OVAL KAFESLİ ARMATÜR - IP20 |
| | AMB. AD./KOLİ | 8/48 |
| | FİYAT (₺) | 254,00 |



APLIK ÇEŞİTLERİ



CE

| | |
|------------|------------------------|
| ÜRÜN ADI | ZETA 4'LÜ APLİK - IP64 |
| ÜRÜN KODU | 001 038 200102 00 11 |
| RENK | 3000K |
| LÜMEN/WATT | 480Lm/4W |
| KUTU ADEDİ | 1 |
| FİYAT (\$) | 10,00 \$ |



CE

| | |
|------------|------------------------|
| ÜRÜN ADI | ZETA 4'LÜ APLİK - IP64 |
| ÜRÜN KODU | 001 038 201102 00 11 |
| RENK | 2R+2B |
| LÜMEN/WATT | 480Lm/4W |
| KUTU ADEDİ | 1 |
| FİYAT (\$) | 10,00 \$ |



CE

| | |
|------------|------------------------|
| ÜRÜN ADI | ZETA 6'LI APLİK - IP64 |
| ÜRÜN KODU | 001 038 200103 00 11 |
| RENK | 3000K |
| LÜMEN/WATT | 720Lm/6W |
| KUTU ADEDİ | 1 |
| FİYAT (\$) | 10,67 \$ |



CE

| | |
|------------|------------------------|
| ÜRÜN ADI | ZETA 6'LI APLİK - IP64 |
| ÜRÜN KODU | 001 038 201103 00 11 |
| RENK | 2R+2G+2B |
| LÜMEN/WATT | 720Lm/6W |
| KUTU ADEDİ | 1 |
| FİYAT (\$) | 10,67 \$ |



CE

| | |
|------------|------------------------|
| ÜRÜN ADI | ZETA 8'Lİ APLİK - IP64 |
| ÜRÜN KODU | 001 038 200104 00 11 |
| RENK | 3000K |
| LÜMEN/WATT | 960Lm/8W |
| KUTU ADEDİ | 1 |
| FİYAT (\$) | 11,33 \$ |



CE

| | |
|------------|------------------------|
| ÜRÜN ADI | ZETA 8'Lİ APLİK - IP64 |
| ÜRÜN KODU | 001 038 201104 00 11 |
| RENK | 2R+2G+2B+2Y |
| LÜMEN/WATT | 960Lm/8W |
| KUTU ADEDİ | 1 |
| FİYAT (\$) | 11,33 \$ |



CE

| | |
|------------|-------------------------|
| ÜRÜN ADI | ZETA 10'LU APLİK - IP64 |
| ÜRÜN KODU | 001 038 200105 00 11 |
| RENK | 3000K |
| LÜMEN/WATT | 1200Lm/10W |
| KUTU ADEDİ | 1 |
| FİYAT (\$) | 15,00 \$ |



CE

| | |
|------------|-------------------------|
| ÜRÜN ADI | ZETA 10'LU APLİK - IP64 |
| ÜRÜN KODU | 001 038 201105 00 11 |
| RENK | 2R+2G+2B+2G+2R |
| LÜMEN/WATT | 1200Lm/10W |
| KUTU ADEDİ | 1 |
| FİYAT (\$) | 15,00 \$ |



CE

| | |
|------------|-------------------------|
| ÜRÜN ADI | KARE KÜÇÜK APLİK - IP44 |
| ÜRÜN KODU | 001 038 200108 00 11 |
| RENK | 3000K |
| LÜMEN/WATT | 500Lm/5W |
| KUTU ADEDİ | 1 |
| FİYAT (\$) | 11,00 \$ |



CE

| | |
|------------|-------------------------|
| ÜRÜN ADI | KARE BÜYÜK APLİK - IP44 |
| ÜRÜN KODU | 001 038 200112 00 11 |
| RENK | 3000K |
| LÜMEN/WATT | 1200Lm/12W |
| KUTU ADEDİ | 1 |
| FİYAT (\$) | 19,33 \$ |



CE

| | |
|------------|----------------------|
| ÜRÜN ADI | MİNA APLİK - IP64 |
| ÜRÜN KODU | 001 038 200116 00 11 |
| RENK | 3000K |
| LÜMEN/WATT | 1000Lm/10W |
| KUTU ADEDİ | 1 |
| FİYAT (\$) | 11,00 \$ |



CE

| | |
|------------|----------------------|
| ÜRÜN ADI | MİLA APLİK - IP64 |
| ÜRÜN KODU | 001 038 200118 00 11 |
| RENK | 3000K |
| LÜMEN/WATT | 1000Lm/10W |
| KUTU ADEDİ | 1 |
| FİYAT (\$) | 19,33 \$ |

YENİ

APLİK ÇEŞİTLERİ



| | |
|---------------|----------------------|
| ÜRÜN ADI | PERA APLİK - IP64 |
| ÜRÜN KODU | 001 038 200120 00 11 |
| RENK | 3000K |
| LÜMEN/WATT | 660Lm/6W |
| KUTU ADEDİ | 1 |
| CE FİYAT (\$) | 13,14 \$ |



| | |
|---------------|----------------------|
| ÜRÜN ADI | HERA APLİK - IP64 |
| ÜRÜN KODU | 001 038 200122 00 11 |
| RENK | 3000K |
| LÜMEN/WATT | 660Lm/6W |
| KUTU ADEDİ | 1 |
| CE FİYAT (\$) | 13,14 \$ |



| | |
|---------------|----------------------|
| ÜRÜN ADI | HAPPY APLİK - IP64 |
| ÜRÜN KODU | 001 038 200124 00 11 |
| RENK | 3000K |
| LÜMEN/WATT | 660Lm/6W |
| KUTU ADEDİ | 1 |
| CE FİYAT (\$) | 12,77 \$ |



Karanlığı Işıkla Buluşturur
SUNBOX Ledli Solar
Projektör



SOLAR BAHÇE APLİK ÇEŞİTLERİ



| | |
|---------------|------------------------------------|
| ÜRÜN ADI | ZETA 4'LÜ LEDLİ SOLAR APLİK - IP65 |
| ÜRÜN KODU | 016 038 200102 |
| RENK | 3000K |
| LÜMEN/WATT | 60Lm/10W |
| AMB. AD./KOLİ | 1/50 |
| FİYAT (\$) | 20,00 \$ |



| | |
|---------------|------------------------------------|
| ÜRÜN ADI | ZETA 6'LI LEDLİ SOLAR APLİK - IP65 |
| ÜRÜN KODU | 016 038 200104 |
| RENK | 3000K |
| LÜMEN/WATT | 90Lm/15W |
| AMB. AD./KOLİ | 1/50 |
| FİYAT (\$) | 28,33 \$ |



| | |
|---------------|---|
| ÜRÜN ADI | VENUS LEDLİ SENSÖRLÜ SOLAR APLİK - IP65 |
| ÜRÜN KODU | 016 038 200106 |
| RENK | 3000K |
| LÜMEN/WATT | 60Lm/10W |
| AMB. AD./KOLİ | 1/80 |
| FİYAT (\$) | 12,82 \$ |



| | |
|---------------|--|
| ÜRÜN ADI | MARS LEDLİ SOLAR BAHÇE ARMATÜRÜ - IP65 |
| ÜRÜN KODU | 016 038 200108 |
| RENK | 3000K |
| LÜMEN/WATT | 40Lm/7W |
| AMB. AD./KOLİ | 1/20 |
| FİYAT (\$) | 26,67 \$ |



| | |
|---------------|---|
| ÜRÜN ADI | JUPİTER LEDLİ SOLAR BAHÇE ARMATÜRÜ - IP65 |
| ÜRÜN KODU | 016 038 200110 |
| RENK | 3000-4500K KUMANDALI |
| LÜMEN/WATT | 380Lm/20W |
| AMB. AD./KOLİ | 1/20 |
| FİYAT (\$) | 44,81 \$ |



| | |
|---------------|----------------------------------|
| ÜRÜN ADI | NEPTUNE LEDLİ SOLAR APLİK - IP65 |
| ÜRÜN KODU | 016 038 200112 |
| RENK | 3000-4500K KUMANDALI |
| LÜMEN/WATT | 380Lm/20W |
| AMB. AD./KOLİ | 1/20 |
| FİYAT (\$) | 38,11 \$ |



| | |
|---------------|--|
| ÜRÜN ADI | SATURN LEDLİ SOLAR BAHÇE ARMATÜRÜ - IP65 |
| ÜRÜN KODU | 016 038 200114 |
| RENK | 3000-4500K KUMANDALI |
| LÜMEN/WATT | 960Lm/50W |
| AMB. AD./KOLİ | 1/6 |
| FİYAT (\$) | 89,91 \$ |

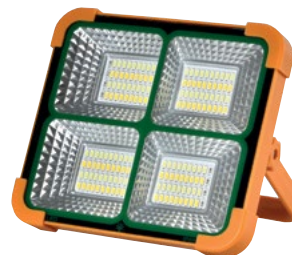

| | |
|---------------|-------------------------------------|
| ÜRÜN ADI | SUNBOX LEDLİ SOLAR PROJEKTÖR - IP65 |
| ÜRÜN KODU | 016 038 200116 |
| RENK | W+R+B |
| LÜMEN/WATT | 1420Lm/200W |
| AMB. AD./KOLİ | 1/20 |
| FİYAT (\$) | 40,00 \$ |

BAHÇE AYDINLATMA

YENİ



| | |
|---------------|------------------------------|
| ÜRÜN ADI | BURGAZ APLİK 28 CM - IP54 |
| ÜRÜN KODU | 016 038 710002 |
| DUY | E27 |
| AMB. AD./KOLİ | 1/18 |
| FİYAT (₺) | 398,24 |



| | |
|---------------|-----------------------------|
| ÜRÜN ADI | SEDEF APLİK 28 CM - IP54 |
| ÜRÜN KODU | 016 038 710006 |
| DUY | E27 |
| AMB. AD./KOLİ | 1/20 |
| FİYAT (₺) | 398,24 |



| | |
|---------------|------------------------------------|
| ÜRÜN ADI | ALİZE KÜP SET ÜSTÜ 27 CM - IP54 |
| ÜRÜN KODU | 016 038 710020 |
| DUY | E27 |
| AMB. AD./KOLİ | 1/12 |
| FİYAT (₺) | 536,67 |



| | |
|---------------|-----------------------------|
| ÜRÜN ADI | ERDEK APLİK 25 CM - IP54 |
| ÜRÜN KODU | 016 038 710010 |
| DUY | E27 |
| AMB. AD./KOLİ | 1/18 |
| FİYAT (₺) | 398,24 |



| | |
|---------------|--------------------------------------|
| ÜRÜN ADI | MARMARA KÜP SET ÜSTÜ 27 CM - IP54 |
| ÜRÜN KODU | 016 038 710021 |
| DUY | E27 |
| AMB. AD./KOLİ | 1/12 |
| FİYAT (₺) | 536,67 |



| | |
|---------------|-------------------------------|
| ÜRÜN ADI | MARMARA APLİK 25 CM - IP54 |
| ÜRÜN KODU | 016 038 710014 |
| DUY | E27 |
| AMB. AD./KOLİ | 1/20 |
| FİYAT (₺) | 421,67 |

YENİ

BAHÇE ARMATÜRLERİ



| Ürün Kodu | Ürün Adı | Ölçü | Ambalaj Adet/Koli | Fiyat (₺) |
|----------------|---------------------------------|-------|-------------------|-----------|
| 016 038 710005 | SEDEF SET ÜSTÜ - IP54 - E27 DUY | 42 CM | 1/16 | 398,24 |
| 016 038 710007 | SEDEF BOLLARD - IP54 - E27 DUY | 60 CM | 1/12 | 515,37 |
| 016 038 710008 | SEDEF BOLLARD - IP54 - E27 DUY | 80 CM | 1/12 | 609,07 |



| Ürün Kodu | Ürün Adı | Ölçü | Ambalaj Adet/Koli | Fiyat (₺) |
|----------------|---------------------------------|-------|-------------------|-----------|
| 016 038 710009 | ERDEK SET ÜSTÜ - IP54 - E27 DUY | 42 CM | 1/18 | 398,24 |
| 016 038 710011 | ERDEK BOLLARD - IP54 - E27 DUY | 60 CM | 1/12 | 515,37 |
| 016 038 710012 | ERDEK BOLLARD - IP54 - E27 DUY | 80 CM | 1/12 | 609,07 |



| Ürün Kodu | Ürün Adı | Ölçü | Ambalaj Adet/Koli | Fiyat (₺) |
|----------------|----------------------------------|-------|-------------------|-----------|
| 016 038 710001 | BURGAZ SET ÜSTÜ - IP54 - E27 DUY | 42 CM | 1/18 | 398,24 |
| 016 038 710003 | BURGAZ BOLLARD - IP54 - E27 DUY | 60 CM | 1/12 | 515,37 |
| 016 038 710004 | BURGAZ BOLLARD - IP54 - E27 DUY | 80 CM | 1/12 | 609,07 |



| Ürün Kodu | Ürün Adı | Ölçü | Ambalaj Adet/Koli | Fiyat (₺) |
|----------------|-----------------------------------|-------|-------------------|-----------|
| 016 038 710013 | MARMARA SET ÜSTÜ - IP54 - E27 DUY | 42 CM | 1/16 | 421,67 |
| 016 038 710015 | MARMARA BOLLARD - IP54 - E27 DUY | 60 CM | 1/12 | 562,22 |
| 016 038 710016 | MARMARA BOLLARD - IP54 - E27 DUY | 80 CM | 1/12 | 655,93 |

BAHÇE ARMATÜRLERİ

CE IP43

| Ürün Kodu | Ürün Adı | Ambalaj Adet/Koli | Fiyat (₺) |
|----------------|------------------------------|-------------------|-----------|
| 016 038 010116 | FLORA BAHÇE ARMATÜRÜ - SİYAH | 1/12 | 334,80 |
| 016 038 020116 | FLORA BAHÇE ARMATÜRÜ - BEYAZ | 1/12 | 334,80 |

| Ürün Kodu | Ürün Adı | Ambalaj Adet/Koli | Fiyat (₺) |
|----------------|------------------------------------|-------------------|-----------|
| 016 038 010117 | FLORA BAHÇE ARMATÜRÜ APLİK - SİYAH | 1/12 | 334,80 |
| 016 038 020117 | FLORA BAHÇE ARMATÜRÜ APLİK - BEYAZ | 1/12 | 334,80 |

| Ürün Kodu | Ürün Adı | Ambalaj Adet/Koli | Fiyat (₺) |
|----------------|---|-------------------|-----------|
| 016 038 412011 | FLORA BAHÇE ARMATÜRÜ TAVAN TİPİ - SİYAH | 1/12 | 349,60 |
| 016 038 412000 | FLORA BAHÇE ARMATÜRÜ TAVAN TİPİ - BEYAZ | 1/12 | 349,60 |

| Ürün Kodu | Ürün Adı | Ambalaj Adet/Koli | Fiyat (₺) |
|----------------|--|-------------------|-----------|
| 016 038 412111 | FLORA BAHÇE ARMATÜRÜ YARIM APLİK - SİYAH | 1/20 | 282,40 |
| 016 038 412100 | FLORA BAHÇE ARMATÜRÜ YARIM APLİK - SİYAH | 1/20 | 282,40 |



CE IP44

| Ürün Kodu | Ürün Adı | Ölçü | Ambalaj Adet/Koli | Fiyat (₺) |
|----------------|------------------------------------|------------------|-------------------|-----------|
| 016 038 010120 | GARDEN UZUN YER AYDINLATMA - SİYAH | 542,3mm x Ø151,8 | 1/8 | 318,70 |
| 016 038 010118 | GARDEN YER AYDINLATMA - SİYAH | 327,5mm x Ø152 | 1/12 | 291,80 |
| 016 038 010122 | GARDEN DUVAR AYDINLATMA - SİYAH | 396mm | 1/20 | 273,00 |

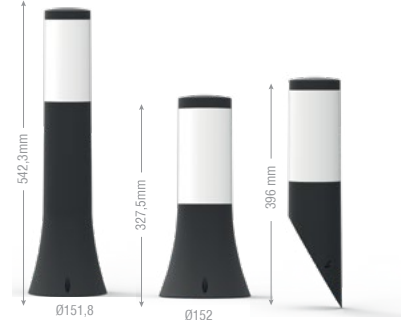

| Ürün Kodu | Ürün Adı | Ölçü | Ambalaj Adet/Koli | Fiyat (₺) |
|----------------|----------------------------------|------------------|-------------------|-----------|
| 016 038 010121 | GARDEN UZUN YER AYDINLATMA - GRİ | 542,3mm x Ø151,8 | 1/8 | 318,70 |
| 016 038 010119 | GARDEN YER AYDINLATMA - GRİ | 327,5mm x Ø152 | 1/12 | 291,80 |
| 016 038 010123 | GARDEN DUVAR AYDINLATMA - GRİ | 396mm | 1/20 | 273,00 |

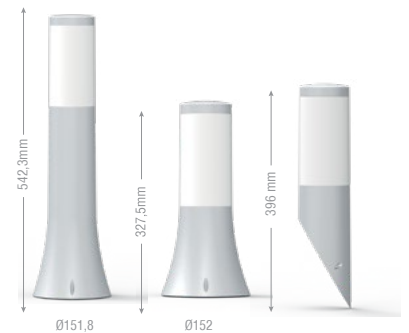

| Ürün Kodu | Ürün Adı | Ambalaj Adet/Koli | Fiyat (₺) |
|----------------|----------------------|-------------------|-----------|
| 016 038 010124 | GARDEN APLİK - SİYAH | 1/16 | 358,70 |
| 016 038 010125 | GARDEN APLİK - GRİ | 1/16 | 358,70 |

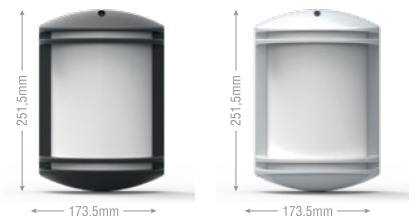

EXIT - ACİL AYDINLATMA ARMATÜRLERİ (LEDLİ) - IP20 CE



102 038 0008XX - CEXA

FİYAT : 644,20 ₺

- *GÖVDE : ABS
- *CAM : Polistren (PS) isteğe bağlı Akrilik(PMMA) veya Policarbon(PC)
- *BASKI : Akrilik ışık geçirgen Translucent Folyo
- *ÇALIŞMA : Acil de ve Şebeke de sürekli çalışma
- *PİL : 3.6V 80mAH NiMH (NikelMethalhidrid)
- *ŞARJ SÜRESİ : 14-20 Saat
- *DEŞARJ SÜRESİ : 180 Dk
- *KORUMA SINIFI : IP20
- *LED : 4.8mm 6000K Beyaz Mantar Led veya 2835 6400K EDİSON OPTO SMD Led
- TÜKETİM : 2 Watt

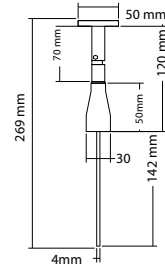
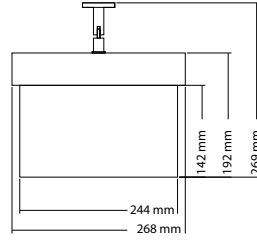

| | | | | | | | |
|----|----|----|----|----|----|----|----|
| | | | | | | | |
| 01 | 02 | 03 | 04 | 05 | 06 | 07 | 08 |
| | | | | | | | |
| 09 | 10 | 11 | 12 | 13 | 14 | | |
| | | | | | | | |
| 15 | 16 | 17 | 18 | 19 | 20 | | |
| | | | | | | | |
| 21 | 22 | 23 | 24 | 25 | 26 | | |
| | | | | | | | |
| 27 | 28 | 29 | 30 | 31 | 32 | | |
| | | | | | | | |
| 33 | 34 | 35 | 36 | | | | |
| | | | | | | | |
| 37 | 38 | 39 | 40 | 41 | 42 | 43 | |
| | | | | | | | |
| 44 | 45 | 46 | 47 | 48 | 49 | 50 | 51 |
| | | | | | | | |
| 52 | 53 | 54 | 55 | 56 | 57 | 58 | 59 |
| | | | | | | | |
| 60 | 61 | 62 | 63 | 64 | 65 | | |

*Sipariş Verdiğiniz Ürünün Sembol Kodunu Yazmayı Unutmayınız.

*Ürün Kodunun Son 2 hanesi olan XX Rakamları Ürünün Sembol Kodunu belirtmektedir.

PANO ve ENDÜSTRİYEL ÜRÜN GRUBU

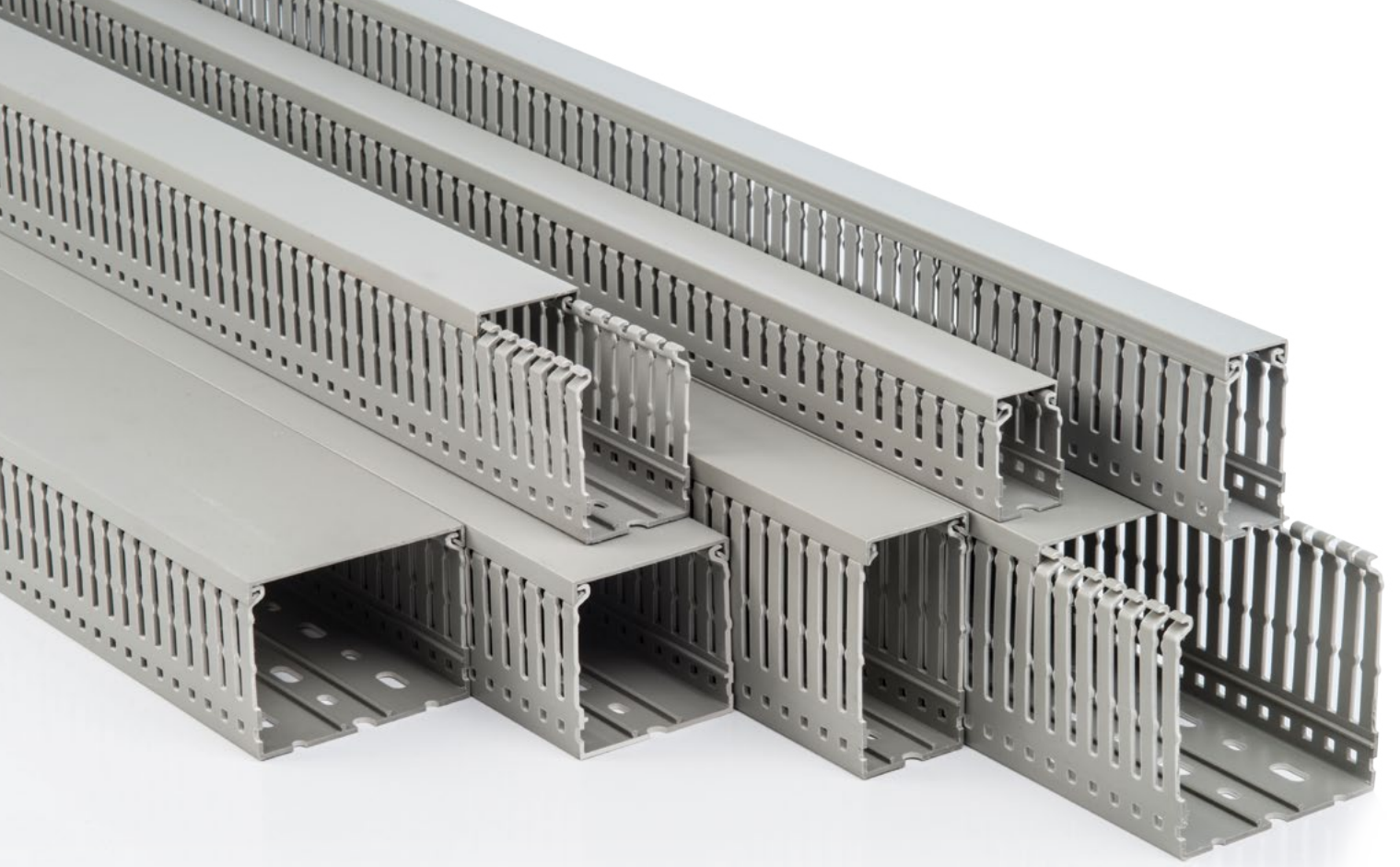

Promex

**PANO TIPI
DELİKLİ
KABLO KANALLARI**

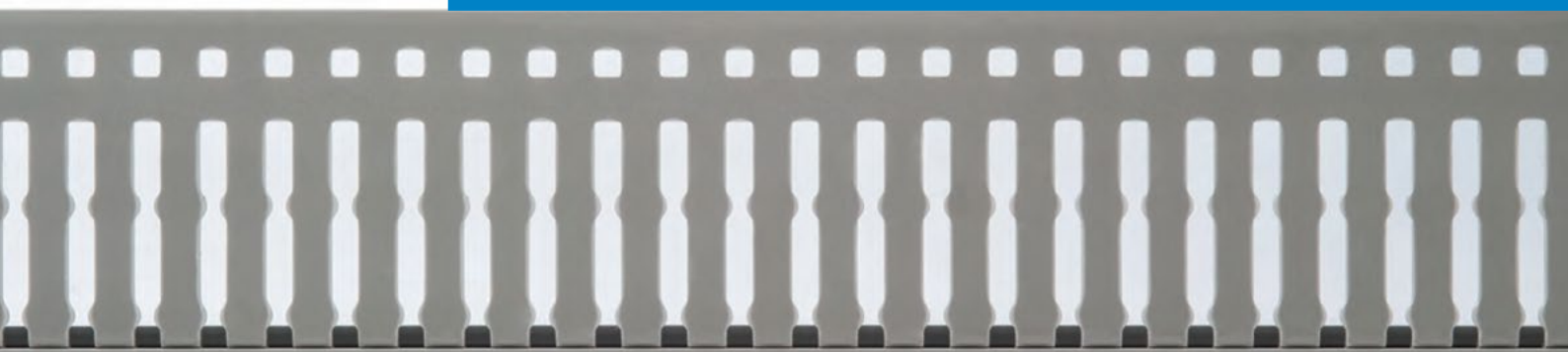



Kanal tırnakları tabanın üst noktasından, herhangi bir el aletine gereksinim duymadan 90 derecelik bükülme sonucu kolayca kırılabilir.

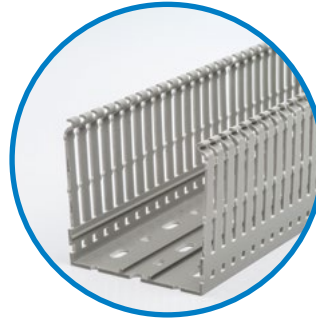

Özel tırnak tasarım yapısı ile kablolarınızı sıkıştırabilirsiniz. Kanal içindeki kabloların, kablo bağı ile bağlanmasına imkan veren delikleri sayesinde daha düzenli ve hızlı kablolama imkanına sahip olursunuz.

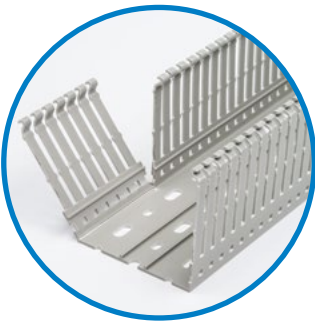

Kanal yan duvarı, kolay kırılma çizgileri sayesinde tabana sıfır olarak kırılabilir.

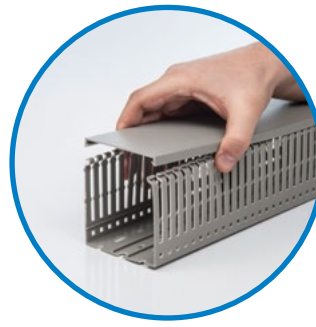

Özel kapak tasarımı, kanalın hangi konumda monte edildiğine bakılmaksızın kapağı kolayca monte etmemizi ve sökmemizi sağlar. Yoğun kablolamalarda bile kapağın kendinden çıkmasını engeller.

UL94-V0 alev iletmez özelliğe sahip PVC hammaddeden imal

Slot aralığı 4/6/4 + 5/8/5 mm genişliğinde

Taban montaj delikleri DIN 43659 standartına uygun

Standart kanal boyları 2mt

EN 50085-2-3 standartlarına uygun

Her türlü sevkiyat ve depolama koşullarına dayanıklı özel karton ambalaj

Standart renk RAL7030 Gri, istek üzerine diğer renkler üretilebilir

CE, RoHS sertifikalı

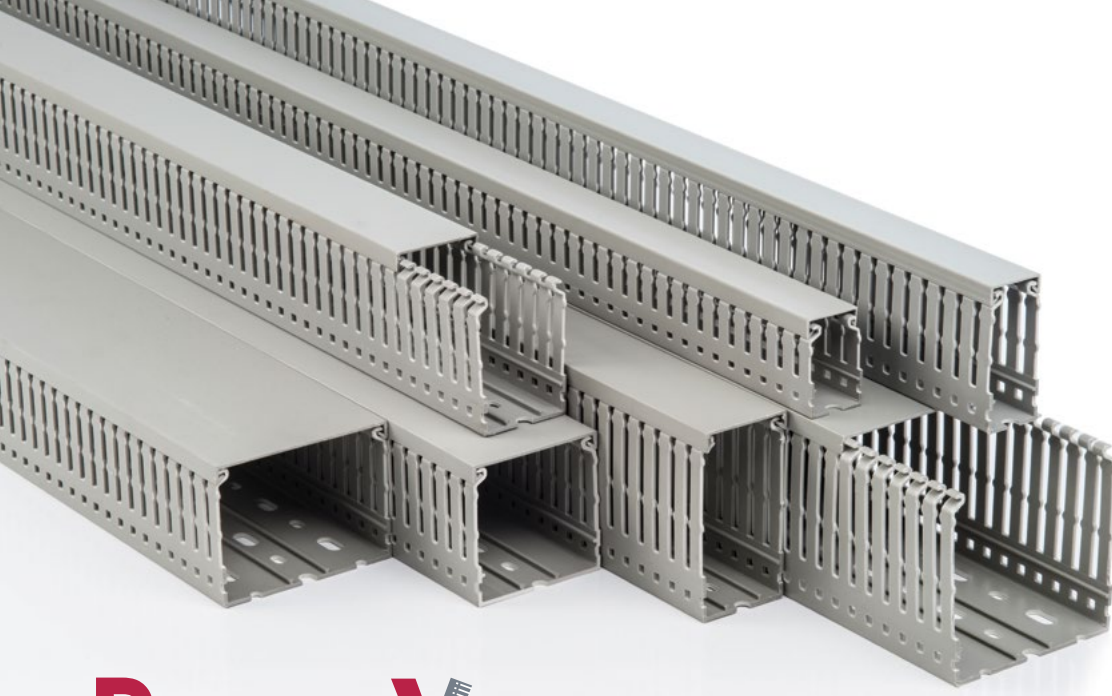

Promex

PANO TİPİ DELİKLİ KABLO KANALLARI



| Ürün Kodu | Ölçü (mm) | Ürün Adı | Slot Aralığı (mm) | Ambalaj/Mt. | Fiyat (₺) |
|------------------------------------|-----------|-----------------------------|-------------------|-------------|-----------|
| PROMEX DELİKLİ KABLO KANALI | | | | | |
| 001 105 025030 20 17 | 25x30 | PROMEX DELİKLİ KABLO KANALI | 4/6/4 mm | 2m. 120 | 86,30 |
| 001 105 025040 20 17 | 25x40 | PROMEX DELİKLİ KABLO KANALI | 4/6/4 mm | 2m. 128 | 92,30 |
| 001 105 025060 20 17 | 25x60 | PROMEX DELİKLİ KABLO KANALI | 4/6/4 mm | 2m. 96 | 121,80 |
| 001 105 025080 20 17 | 25x80 | PROMEX DELİKLİ KABLO KANALI | 4/6/4 mm | 2m. 64 | 156,10 |
| 001 105 040040 20 17 | 40x40 | PROMEX DELİKLİ KABLO KANALI | 4/6/4 mm | 2m. 70 | 119,80 |
| 001 105 040060 20 17 | 40x60 | PROMEX DELİKLİ KABLO KANALI | 4/6/4 mm | 2m. 60 | 141,00 |
| 001 105 040080 20 17 | 40x80 | PROMEX DELİKLİ KABLO KANALI | 4/6/4 mm | 2m. 40 | 187,20 |
| 001 105 040100 20 17 | 40x100 | PROMEX DELİKLİ KABLO KANALI | 5/8/5 mm | 2m. 40 | 227,60 |
| 001 105 060040 20 17 | 60x40 | PROMEX DELİKLİ KABLO KANALI | 4/6/4 mm | 2m. 50 | 164,50 |
| 001 105 060060 20 17 | 60x60 | PROMEX DELİKLİ KABLO KANALI | 4/6/4 mm | 2m. 48 | 196,70 |
| 001 105 060080 20 17 | 60x80 | PROMEX DELİKLİ KABLO KANALI | 4/6/4 mm | 2m. 32 | 243,60 |
| 001 105 060100 20 17 | 60x100 | PROMEX DELİKLİ KABLO KANALI | 5/8/5 mm | 2m. 32 | 262,50 |
| 001 105 080060 20 17 | 80x60 | PROMEX DELİKLİ KABLO KANALI | 4/6/4 mm | 2m. 25 | 234,40 |
| 001 105 080080 20 17 | 80x80 | PROMEX DELİKLİ KABLO KANALI | 4/6/4 mm | 2m. 24 | 291,40 |
| 001 105 080100 20 17 | 80x100 | PROMEX DELİKLİ KABLO KANALI | 5/8/5 mm | 2m. 24 | 433,00 |
| 001 105 100060 20 17 | 100x60 | PROMEX DELİKLİ KABLO KANALI | 4/6/4 mm | 2m. 20 | 321,80 |
| 001 105 100080 20 17 | 100x80 | PROMEX DELİKLİ KABLO KANALI | 4/6/4 mm | 2m. 20 | 326,80 |
| 001 105 100100 20 17 | 100x100 | PROMEX DELİKLİ KABLO KANALI | 5/8/5 mm | 2m. 16 | 508,20 |
| 001 105 120060 20 17 | 120x60 | PROMEX DELİKLİ KABLO KANALI | 4/6/4 mm | 2m. 20 | 332,20 |
| 001 105 120080 20 17 | 120x80 | PROMEX DELİKLİ KABLO KANALI | 4/6/4 mm | 2m. 16 | 438,30 |

PROMEX KABLO KANALI KAPAKLARI

| | | | | | |
|----------------------|---------|--------------|--|----|-------|
| 001 016 100025 20 17 | 25'LİK | PROMEX KAPAK | | 50 | 24,80 |
| 001 016 100040 20 17 | 40'LİK | PROMEX KAPAK | | 50 | 30,90 |
| 001 016 100060 20 17 | 60'LİK | PROMEX KAPAK | | 50 | 47,60 |
| 001 016 100080 20 17 | 80'LİK | PROMEX KAPAK | | 50 | 59,20 |
| 001 016 100100 20 17 | 100'LÜK | PROMEX KAPAK | | 50 | 68,90 |
| 001 016 100120 20 17 | 120'LİK | PROMEX KAPAK | | 50 | 85,60 |

XX : 10 1mt. delikli kablo kanalı için.
XX : 20 2mt. delikli kablo kanalı için.

| Ürün Kodu | Ölçü (mm) | Ürün Adı | Ambalaj Koli -1 mt | Ambalaj Koli - 2 mt | Fiyat (₺) |
|-----------|-----------|----------|--------------------|---------------------|-----------|
|-----------|-----------|----------|--------------------|---------------------|-----------|

PANO İÇİN MEKS DELİKLİ KABLO KANALLAR (GRİ)

| | | | | | |
|----------------------|---------|--------------------------------|---------|----------|--------|
| 001 005 025025 XX 17 | 25x25 | MEKS DELİKLİ KABLO KANALI(GRİ) | 1mt. 64 | 2mt. 120 | 55,70 |
| 001 005 025040 XX 17 | 25x40 | MEKS DELİKLİ KABLO KANALI(GRİ) | 1mt. 40 | 2mt. 80 | 70,70 |
| 001 005 025060 XX 17 | 25x60 | MEKS DELİKLİ KABLO KANALI(GRİ) | 1mt. 36 | 2mt. 80 | 114,30 |
| 001 005 040040 XX 17 | 40x40 | MEKS DELİKLİ KABLO KANALI(GRİ) | 1mt. 25 | 2mt. 50 | 90,50 |
| 001 005 040060 XX 17 | 40x60 | MEKS DELİKLİ KABLO KANALI(GRİ) | 1mt. 24 | 2mt. 48 | 120,00 |
| 001 005 060040 XX 17 | 60x40 | MEKS DELİKLİ KABLO KANALI(GRİ) | 1mt. 24 | 2mt. 48 | 122,70 |
| 001 005 060060 XX 17 | 60x60 | MEKS DELİKLİ KABLO KANALI(GRİ) | 1mt. 16 | 2mt. 32 | 154,80 |
| 001 005 060080 XX 17 | 60x80 | MEKS DELİKLİ KABLO KANALI(GRİ) | 1mt. 12 | 2mt. 24 | 191,10 |
| 001 005 060100 XX 17 | 60x100 | MEKS DELİKLİ KABLO KANALI(GRİ) | 1mt. 8 | 2mt. 16 | 210,50 |
| 001 005 040080 XX 17 | 40x80 | MEKS DELİKLİ KABLO KANALI(GRİ) | 1mt. 18 | 2mt. 36 | 175,60 |
| 001 005 080060 XX 17 | 80x60 | MEKS DELİKLİ KABLO KANALI(GRİ) | 1mt. 12 | 2mt. 24 | 218,00 |
| 001 005 100060 XX 17 | 100x60 | MEKS DELİKLİ KABLO KANALI(GRİ) | 1mt. 8 | 2mt. 16 | 277,30 |
| 001 005 100100 XX 17 | 100x100 | MEKS DELİKLİ KABLO KANALI(GRİ) | 1mt. 4 | 2mt. 8 | 360,70 |

PANO İÇİN MEKS DELİKLİ KABLO KANALLAR (MAVİ)

| | | | | | |
|----------------------|---------|----------------------------------|---------|----------|--------|
| 001 005 025025 XX 13 | 25x25 | MEKS DELİKLİ KABLO KANALI(MAVİ) | 1mt. 64 | 2mt. 120 | 58,20 |
| 001 005 025040 XX 13 | 25x40 | MEKS DELİKLİ KABLO KANALI(MAVİ) | 1mt. 40 | 2mt. 80 | 73,80 |
| 001 005 025060 XX 13 | 25x60 | MEKS DELİKLİ KABLO KANALI(MAVİ) | 1mt. 36 | 2mt. 80 | 122,50 |
| 001 005 040040 XX 13 | 40x40 | MEKS DELİKLİ KABLO KANALI(MAVİ) | 1mt. 25 | 2mt. 50 | 94,50 |
| 001 005 040060 XX 13 | 40x60 | MEKS DELİKLİ KABLO KANALI(MAVİ) | 1mt. 24 | 2mt. 48 | 126,70 |
| 001 005 060040 XX 13 | 60x40 | MEKS DELİKLİ KABLO KANALI(MAVİ) | 1mt. 24 | 2mt. 48 | 128,60 |
| 001 005 060060 XX 13 | 60x60 | MEKS DELİKLİ KABLO KANALI(MAVİ) | 1mt. 16 | 2mt. 32 | 165,70 |
| 001 005 060080 XX 13 | 60x80 | MEKS DELİKLİ KABLO KANALI (MAVİ) | 1mt. 12 | 2mt. 24 | 207,50 |
| 001 005 060100 XX 13 | 60x100 | MEKS DELİKLİ KABLO KANALI (MAVİ) | 1mt. 8 | 2mt. 16 | 221,90 |
| 001 005 040080 XX 13 | 40x80 | MEKS DELİKLİ KABLO KANALI(MAVİ) | 1mt. 18 | 2mt. 36 | 202,40 |
| 001 005 080060 XX 13 | 80x60 | MEKS DELİKLİ KABLO KANALI(MAVİ) | 1mt. 12 | 2mt. 24 | 247,90 |
| 001 005 100060 XX 13 | 100x60 | MEKS DELİKLİ KABLO KANALI(MAVİ) | 1mt. 8 | 2mt. 16 | 309,60 |
| 001 005 100100 XX 13 | 100x100 | MEKS DELİKLİ KABLO KANALI(MAVİ) | 1mt. 4 | 2mt. 8 | 417,30 |

YAPIŞKAN BANTLI MEKS DELİKLİ KABLO KANALLAR (GRİ)

| | | | | | |
|----------------------|---------|--|---------|----------|--------|
| 001 008 025025 XX 17 | 25x25 | MEKS DELİKLİ KABLO KANALI(YPŞK. BANTLI)(GRİ) | 1mt. 64 | 2mt. 120 | 60,40 |
| 001 008 025040 XX 17 | 25x40 | MEKS DELİKLİ KABLO KANALI(YPŞK. BANTLI)(GRİ) | 1mt. 40 | 2mt. 80 | 74,50 |
| 001 008 025060 XX 17 | 25x60 | MEKS DELİKLİ KABLO KANALI(YPŞK. BANTLI)(GRİ) | 1mt. 36 | 2mt. 80 | 121,80 |
| 001 008 040040 XX 17 | 40x40 | MEKS DELİKLİ KABLO KANALI(YPŞK. BANTLI)(GRİ) | 1mt. 25 | 2mt. 50 | 94,20 |
| 001 008 040060 XX 17 | 40x60 | MEKS DELİKLİ KABLO KANALI(YPŞK. BANTLI)(GRİ) | 1mt. 24 | 2mt. 48 | 126,50 |
| 001 008 060040 XX 17 | 60x40 | MEKS DELİKLİ KABLO KANALI(YPŞK. BANTLI)(GRİ) | 1mt. 24 | 2mt. 48 | 130,40 |
| 001 008 060060 XX 17 | 60x60 | MEKS DELİKLİ KABLO KANALI(YPŞK. BANTLI)(GRİ) | 1mt. 16 | 2mt. 32 | 166,70 |
| 001 008 060080 XX 17 | 60x80 | MEKS DELİKLİ KABLO KANALI(YPŞK. BANTLI)(GRİ) | 1mt. 12 | 2mt. 24 | 201,00 |
| 001 008 060100 XX 17 | 60x100 | MEKS DELİKLİ KABLO KANALI(YPŞK. BANTLI)(GRİ) | 1mt. 8 | 2mt. 16 | 223,90 |
| 001 008 040080 XX 17 | 40x80 | MEKS DELİKLİ KABLO KANALI(YPŞK. BANTLI)(GRİ) | 1mt. 18 | 2mt. 36 | 201,20 |
| 001 008 080060 XX 17 | 80x60 | MEKS DELİKLİ KABLO KANALI(YPŞK. BANTLI)(GRİ) | 1mt. 12 | 2mt. 24 | 247,50 |
| 001 008 100060 XX 17 | 100x60 | MEKS DELİKLİ KABLO KANALI(YPŞK. BANTLI)(GRİ) | 1mt. 8 | 2mt. 16 | 315,30 |
| 001 008 100100 XX 17 | 100x100 | MEKS DELİKLİ KABLO KANALI(YPŞK. BANTLI)(GRİ) | 1mt. 4 | 2mt. 8 | 407,40 |

YAPIŞKAN BANTLI MEKS DELİKLİ KABLO KANALLAR (MAVİ)

| | | | | | |
|----------------------|---------|---|---------|----------|--------|
| 001 008 025025 XX 13 | 25x25 | MEKS DELİKLİ KABLO KANALI(YPŞK. BANTLI)(MAVİ) | 1mt. 64 | 2mt. 120 | 62,00 |
| 001 008 025040 XX 13 | 25x40 | MEKS DELİKLİ KABLO KANALI(YPŞK. BANTLI)(MAVİ) | 1mt. 40 | 2mt. 80 | 77,70 |
| 001 008 025060 XX 13 | 25x60 | MEKS DELİKLİ KABLO KANALI(YPŞK. BANTLI)(MAVİ) | 1mt. 36 | 2mt. 80 | 132,40 |
| 001 008 040040 XX 13 | 40x40 | MEKS DELİKLİ KABLO KANALI(YPŞK. BANTLI)(MAVİ) | 1mt. 25 | 2mt. 50 | 100,00 |
| 001 008 040060 XX 13 | 40x60 | MEKS DELİKLİ KABLO KANALI(YPŞK. BANTLI)(MAVİ) | 1mt. 24 | 2mt. 48 | 131,10 |
| 001 008 060040 XX 13 | 60x40 | MEKS DELİKLİ KABLO KANALI(YPŞK. BANTLI)(MAVİ) | 1mt. 24 | 2mt. 48 | 136,00 |
| 001 008 060060 XX 13 | 60x60 | MEKS DELİKLİ KABLO KANALI(YPŞK. BANTLI)(MAVİ) | 1mt. 16 | 2mt. 32 | 176,50 |
| 001 008 060080 XX 13 | 60x80 | MEKS DELİKLİ KABLO KANALI(YPŞK. BANTLI)(MAVİ) | 1mt. 12 | 2mt. 24 | 215,10 |
| 001 008 060100 XX 13 | 60x100 | MEKS DELİKLİ KABLO KANALI(YPŞK. BANTLI)(MAVİ) | 1mt. 8 | 2mt. 16 | 239,30 |
| 001 008 040080 XX 13 | 40x80 | MEKS DELİKLİ KABLO KANALI(YPŞK. BANTLI)(MAVİ) | 1mt. 18 | 2mt. 36 | 234,80 |
| 001 008 080060 XX 13 | 80x60 | MEKS DELİKLİ KABLO KANALI(YPŞK. BANTLI)(MAVİ) | 1mt. 12 | 2mt. 24 | 283,30 |
| 001 008 100060 XX 13 | 100x60 | MEKS DELİKLİ KABLO KANALI(YPŞK. BANTLI)(MAVİ) | 1mt. 8 | 2mt. 16 | 351,80 |
| 001 008 100100 XX 13 | 100x100 | MEKS DELİKLİ KABLO KANALI(YPŞK. BANTLI)(MAVİ) | 1mt. 4 | 2mt. 8 | 470,30 |

| Ürün Kodu | Ölçü (mm) | Ürün Adı | Ambalaj Kutu /Adet | Fiyat (₺) |
|-----------|-----------|----------|--------------------|-----------|
|-----------|-----------|----------|--------------------|-----------|

KABLO TUTUCU APARATI

| | | | | |
|----------------------|-------|----------------------|----|-------|
| 001 050 010001 00 00 | 25x40 | KABLO TUTUCU APARATI | 50 | 30,50 |
| 001 050 010002 00 00 | 40x40 | KABLO TUTUCU APARATI | 50 | 32,80 |
| 001 050 010003 00 00 | 60x40 | KABLO TUTUCU APARATI | 50 | 33,70 |

KABLO TUTUCU YAN APARATI

| | | | | |
|----------------------|----------|--------------------------|-----|-------|
| 001 050 020001 00 00 | 40X40/60 | KABLO TUTUCU YAN APARATI | 100 | 9,50 |
| 001 050 020002 00 00 | 60X40/60 | KABLO TUTUCU YAN APARATI | 100 | 9,80 |
| 001 050 020004 00 00 | 100X60 | KABLO TUTUCU YAN APARATI | 100 | 17,40 |

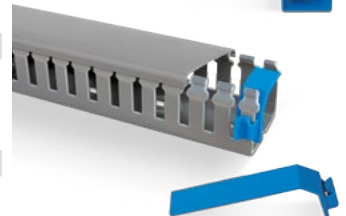
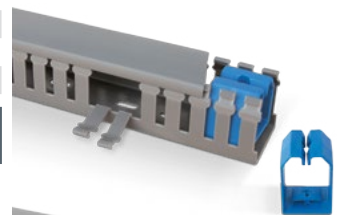
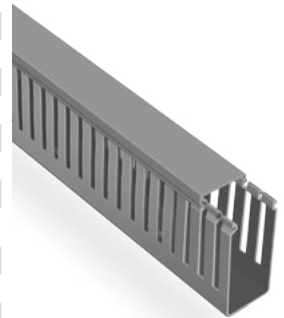
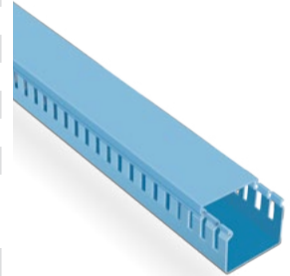
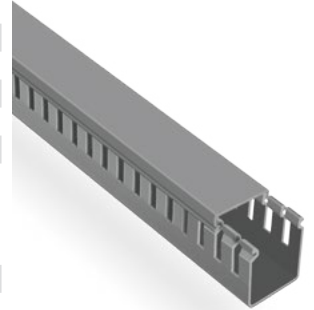

Promex^{PANO}



IP65 CE

PROMEX OPAK KAPAKLI ABS PANOLAR

| Ürün Kodu | Ölçü (mm) | Ürün Adı | Ağırlık (kg) | Adet | Fiyat (₺) |
|----------------------|-----------|----------------------------------|--------------|------|-----------|
| 001 046 203013 00 17 | 20x30x13 | PROMEX PLASTİK OPAK KAPAKLI PANO | 1,70 | 1 | 827,10 |
| 001 046 253515 00 17 | 25x35x15 | PROMEX PLASTİK OPAK KAPAKLI PANO | 2,20 | 1 | 1.201,80 |
| 001 046 304017 00 17 | 30x40x17 | PROMEX PLASTİK OPAK KAPAKLI PANO | 3,00 | 1 | 1.488,00 |
| 001 046 304022 00 17 | 30x40x22 | PROMEX PLASTİK OPAK KAPAKLI PANO | 3,40 | 1 | 1.760,20 |
| 001 046 355019 00 17 | 35x50x19 | PROMEX PLASTİK OPAK KAPAKLI PANO | 4,30 | 1 | 2.162,50 |
| 001 046 405018 00 17 | 40x50x18 | PROMEX PLASTİK OPAK KAPAKLI PANO | 4,30 | 1 | 2.380,60 |
| 001 046 405024 00 17 | 40x50x24 | PROMEX PLASTİK OPAK KAPAKLI PANO | 5,60 | 1 | 2.686,60 |
| 001 046 406020 00 17 | 40x60x20 | PROMEX PLASTİK OPAK KAPAKLI PANO | 6,00 | 1 | 2.956,70 |
| 001 046 507025 00 17 | 50x70x25 | PROMEX PLASTİK OPAK KAPAKLI PANO | 10,10 | 1 | 4.477,80 |
| 001 046 608026 00 17 | 60x80x26 | PROMEX PLASTİK OPAK KAPAKLI PANO | 13,50 | 1 | 7.113,50 |

PROMEX ŞEFFAF KAPAKLI ABS PANOLAR

| Ürün Kodu | Ölçü (mm) | Ürün Adı | Ağırlık (kg) | Adet | Fiyat (₺) |
|----------------------|-----------|------------------------------------|--------------|------|-----------|
| 001 046 203013 00 44 | 20x30x13 | PROMEX PLASTİK ŞEFFAF KAPAKLI PANO | 1,70 | 1 | 872,60 |
| 001 046 253515 00 44 | 25x35x15 | PROMEX PLASTİK ŞEFFAF KAPAKLI PANO | 2,20 | 1 | 1.220,00 |
| 001 046 304017 00 44 | 30x40x17 | PROMEX PLASTİK ŞEFFAF KAPAKLI PANO | 3,00 | 1 | 1.498,40 |
| 001 046 304022 00 44 | 30x40x22 | PROMEX PLASTİK ŞEFFAF KAPAKLI PANO | 3,40 | 1 | 1.776,90 |
| 001 046 355019 00 44 | 35x50x19 | PROMEX PLASTİK ŞEFFAF KAPAKLI PANO | 4,30 | 1 | 2.183,50 |
| 001 046 405018 00 44 | 40x50x18 | PROMEX PLASTİK ŞEFFAF KAPAKLI PANO | 4,30 | 1 | 2.373,70 |
| 001 046 405024 00 44 | 40x50x24 | PROMEX PLASTİK ŞEFFAF KAPAKLI PANO | 5,60 | 1 | 2.821,20 |
| 001 046 406020 00 44 | 40x60x20 | PROMEX PLASTİK ŞEFFAF KAPAKLI PANO | 6,00 | 1 | 2.960,80 |
| 001 046 507025 00 44 | 50x70x25 | PROMEX PLASTİK ŞEFFAF KAPAKLI PANO | 10,10 | 1 | 4.481,60 |
| 001 046 608026 00 44 | 60x80x26 | PROMEX PLASTİK ŞEFFAF KAPAKLI PANO | 13,50 | 1 | 7.133,80 |



IP65 CE

PROMEX OPAK KAPAKLI ABS OTOMAT PANOLAR

| Ürün Kodu | Ölçü (mm) | Ürün Adı | Ağırlık (kg) | Adet | Fiyat (₺) |
|----------------------|-----------|---------------------------|--------------|------|-----------|
| 001 046 253515 01 17 | 25x35x15 | PROMEX 18 OTOMATLI (9x2) | 2,50 | 1 | 2.241,00 |
| 001 046 304017 01 17 | 30x40x17 | PROMEX 24 OTOMATLI (12x2) | 3,40 | 1 | 2.672,80 |
| 001 046 355019 01 17 | 35x50x19 | PROMEX 45 OTOMATLI (15x3) | 4,50 | 1 | 3.417,30 |
| 001 046 406020 01 17 | 40x60x20 | PROMEX 60 OTOMATLI (15x4) | 6,00 | 1 | 4.084,80 |



IP65 CE

PROMEX ŞEFFAF KAPAKLI ABS OTOMAT PANOLAR

| Ürün Kodu | Ölçü (mm) | Ürün Adı | Ağırlık (kg) | Adet | Fiyat (₺) |
|----------------------|-----------|---------------------------|--------------|------|-----------|
| 001 046 253515 01 44 | 25x35x15 | PROMEX 18 OTOMATLI (9x2) | 2,50 | 1 | 2.254,00 |
| 001 046 304017 01 44 | 30x40x17 | PROMEX 24 OTOMATLI (12x2) | 3,40 | 1 | 2.681,80 |
| 001 046 355019 01 44 | 35x50x19 | PROMEX 45 OTOMATLI (15x3) | 4,50 | 1 | 3.436,50 |
| 001 046 406020 01 44 | 40x60x20 | PROMEX 60 OTOMATLI (15x4) | 6,00 | 1 | 4.333,60 |



PANO PRİZLERİ



ÜRÜN KODU 010 104 000157

ÜRÜN ADI MRP-16 1x16 RAY TİPİ PANO PRİZİ

AMB. AD./KOLİ 10

FİYAT (₺) 146,70



ÜRÜN KODU 010 104 000158

ÜRÜN ADI MRP-LED 10x16 RAY TİPİ PANO PRİZİ - LEDLİ

AMB. AD./KOLİ 10

FİYAT (₺) 220,00



ÜRÜN KODU 010 104 000159

ÜRÜN ADI MRP-UPS 1X16 RAY TİPİ PANO PRİZİ - UPS

AMB. AD./KOLİ 10

FİYAT (₺) 220,00



GALVANİZ TABAN SAÇLARI

| Ürün Kodu | Ölçü (mm) | Ürün Adı | Adet | Fiyat (₺) |
|----------------------|------------|-------------------------|------|-----------|
| 000 702 203013 00 00 | 20x30x13 | GALVANİZ TABAN SAÇI 1mm | 1 | 166,20 |
| 000 702 253515 00 00 | 25x35x15 | GALVANİZ TABAN SAÇI 1mm | 1 | 186,10 |
| 000 702 304017 00 00 | 30x40x17 | GALVANİZ TABAN SAÇI 1mm | 1 | 241,40 |
| 000 702 304022 00 00 | 30x40x22 | GALVANİZ TABAN SAÇI 1mm | 1 | 248,10 |
| 000 702 355019 00 00 | 35x50x19 | GALVANİZ TABAN SAÇI 1mm | 1 | 351,40 |
| 000 702 405018 00 00 | 40x50x17,5 | GALVANİZ TABAN SAÇI 1mm | 1 | 413,30 |
| 000 702 405024 00 00 | 40x50x24 | GALVANİZ TABAN SAÇI 1mm | 1 | 403,50 |
| 000 702 406020 00 00 | 40x60x20 | GALVANİZ TABAN SAÇI 1mm | 1 | 474,80 |
| 000 702 507025 00 00 | 50x70x25 | GALVANİZ TABAN SAÇI 1mm | 1 | 710,80 |



MODÜLER KİTLER ve SEPERATÖRLER

| Ürün Kodu | Ölçü (mm) | Ürün Adı | Adet | Fiyat (₺) |
|----------------------|-----------|--------------------|------|-----------|
| 000 700 253515 01 17 | 25X35X15 | 18 OTOMATLI (9X2) | 1 | 1.367,20 |
| 000 700 304017 01 17 | 30X40X17 | 24 OTOMATLI (12X2) | 1 | 1.553,60 |
| 000 700 355019 01 17 | 35X50X19 | 45 OTOMATLI (15X3) | 1 | 2.114,70 |
| 000 700 406020 01 17 | 40X60X20 | 60 OTOMATLI (15X4) | 1 | 2.204,80 |
| 000 700 253515 00 17 | 25X35X15 | PLASTİK PERDE | 1 | 188,10 |
| 000 700 304017 00 17 | 30X40X17 | PLASTİK PERDE | 1 | 249,10 |
| 000 700 355019 00 17 | 35X50X19 | PLASTİK PERDE | 1 | 395,60 |
| 000 700 406020 00 17 | 40X60X20 | PLASTİK PERDE | 1 | 440,80 |



000 705 000720 00 00



000 700 000710 00 17



000 700 000711 00 17



000 700 000712 00 17



000 705 000721 00 00

PANO AKSESUARLARI

| Ürün Kodu | Ürün Adı | Adet | Fiyat (₺) |
|----------------------|--|------|-----------|
| 000 705 000720 00 00 | PANO KİLİT GÖBEK TAKIMI (SET) | 1 | 67,80 |
| 000 700 000710 00 17 | PANO DUVAR MONTAJ APARATI | 1 | 23,28 |
| 000 700 000711 00 17 | PANO ÜÇGEN ANAHTAR | 1 | 24,67 |
| 000 700 000712 00 17 | PANO SEPERATÖRÜ TUTTURMA VİDASI | 1 | 34,91 |
| 000 705 000721 00 00 | PLASTİK KİLİTLENEBİLİR PANO (METAL) KİLİDİ | 1 | 474,31 |

ENERJİ TASARRUFU SAĞLAR

Doğru sıcaklık değerini korumak için ısıtma veya soğutma cihazlarını açıp kapatarak veya bir ısı transfer sıvısının akışını gerektiği gibi düzenleyerek kontrol yapar.



DİJİTAL TERMOSTAT ve HİGROSTAT

Teknik Veriler için
Okutunuz



| | |
|-----------|------------------------------------|
| ÜRÜN ADI | PDT 50-150 SICAKLIK KONTROL CİHAZI |
| ÜRÜN KODU | 048 095 000304 |
| ADET | 1 |
| FİYAT | 201,70 \$ |

| | |
|-----------|---------------------------------------|
| ÜRÜN ADI | HT-310 SICAKLIK VE NEM KONTROL CİHAZI |
| ÜRÜN KODU | 048 095 000305 |
| ADET | 1 |
| FİYAT | 231,20 \$ |

* NOT: PTC SENSÖR CİHAZ DAHİLİNDEDİR.

* NOT: SICAKLIK VE NEM SENSÖRÜ CİHAZ DAHİLİNDEDİR.

PROMEX SERİSİ

TERMOSTAT ve HİGROSTAT

EKOFAN SERİSİ

TERMOSTAT ve HİGROSTAT



ISITMA TERMOSTAT - NK

| | |
|---------------|----------------|
| ÜRÜN KODU | 048 095 000300 |
| AYAR SAHASI | 0-60°C |
| KONTAK TİPİ | NK |
| KORUMA SINIFI | IP20 |
| AĞIRLIK | 45 GR |
| ADET / KOLİ | 135 |
| FİYAT | 11,80 \$ |



SOĞUTUCU TERMOSTAT

| | |
|---------------|----------------|
| ÜRÜN KODU | 048 095 101141 |
| AYAR SAHASI | 0-60°C |
| KONTAK TİPİ | NO |
| KORUMA SINIFI | IP20 |
| AĞIRLIK | 45 GR |
| ADET / KOLİ | 1 |
| FİYAT | 6,79 \$ |



SOĞUTMA TERMOSTAT - NA

| | |
|---------------|----------------|
| ÜRÜN KODU | 048 095 000301 |
| AYAR SAHASI | 0-60°C |
| KONTAK TİPİ | NA |
| KORUMA SINIFI | IP20 |
| AĞIRLIK | 45 GR |
| ADET / KOLİ | 135 |
| FİYAT | 11,80 \$ |



ISITICI TERMOSTAT

| | |
|---------------|----------------|
| ÜRÜN KODU | 048 095 101140 |
| AYAR SAHASI | 0-60°C |
| KONTAK TİPİ | NC |
| KORUMA SINIFI | IP20 |
| AĞIRLIK | 45 GR |
| ADET / KOLİ | 1 |
| FİYAT | 6,79 \$ |



DUAL TERMOSTAT - NK+NA

| | |
|---------------|-----------------|
| ÜRÜN KODU | 048 095 000302 |
| AYAR SAHASI | 0-60°C / 0-60°C |
| KONTAK TİPİ | NK+NA |
| KORUMA SINIFI | IP20 |
| AĞIRLIK | 80 GR |
| ADET / KOLİ | 60 |
| FİYAT | 24,10 \$ |



MULTİ TERMOSTAT

| | |
|---------------|-----------------|
| ÜRÜN KODU | 048 095 101142 |
| AYAR SAHASI | 0-60°C / 0-60°C |
| KONTAK TİPİ | NC+NO |
| KORUMA SINIFI | IP20 |
| AĞIRLIK | 80 GR |
| ADET / KOLİ | 1 |
| FİYAT | 23,40 \$ |



MEKANİK HİGROSTAT - 1CO

| | |
|---------------|----------------|
| ÜRÜN KODU | 048 095 000303 |
| AYAR SAHASI | %10-90RH |
| KONTAK TİPİ | 1CO |
| KORUMA SINIFI | IP20 |
| AĞIRLIK | 180 GR |
| ADET / KOLİ | 30 |
| FİYAT | 93,50 \$ |



HİGROSTAT

| | |
|---------------|----------------|
| ÜRÜN KODU | 048 095 101143 |
| AYAR SAHASI | %40-90RH |
| KONTAK TİPİ | 1CO |
| KORUMA SINIFI | IP20 |
| AĞIRLIK | 180 GR |
| ADET / KOLİ | 1 |
| FİYAT | 70,30 \$ |



ODA TERMOSTAT

| | |
|---------------|----------------|
| ÜRÜN KODU | 048 095 101144 |
| AYAR SAHASI | %10-90RH |
| KONTAK TİPİ | 1CO |
| KORUMA SINIFI | IP20 |
| AĞIRLIK | 180 GR |
| ADET / KOLİ | 1 |
| FİYAT | 75,00 \$ |



Teknik Veriler İçin
Okutunuz

PROMEX SERİSİ TEPE FANLARI



IP54



Poliüretan Conta



Radyal Fan

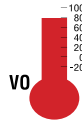

VO Alev İletmez ABS

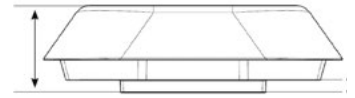
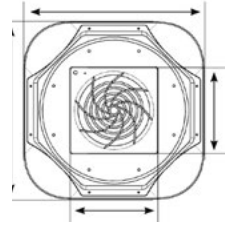

PROMEX TEPE FANLARI

| Ürün Kodu | Fan Tipi | Besleme | Güç (W) | Nominal Akım | Gürültü Seviyesi | Kapasite | Adet | Fiyat |
|----------------|---------------------|------------------|---------|--------------|------------------|----------|------|-----------|
| 048 095 000100 | Ø172x163x51 AKSİYEL | 220V AC 50/60 Hz | 25/32W | 0,11/0,15A | 57 dB | 400 m³/h | 1 | 132,80 \$ |
| 048 095 000101 | Ø190x68 RADYAL | 220V AC 50/60 Hz | 58/75W | 0,26/0,34A | 62 dB | 560 m³/h | 1 | 199,30 \$ |
| 048 095 000102 | Ø220X71 RADYAL | 220V AC 50/60 Hz | 85/90W | 0,38/0,44A | 73 dB | 970 m³/h | 1 | 232,70 \$ |



Vidasız hızlı ve kolay montaj !



IP54



Poliüretan Conta



Radyal Fan

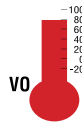

VO Alev İletmez ABS



Hızlı ve Kolay Montaj

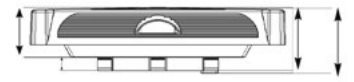
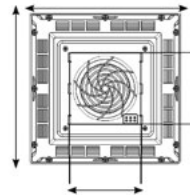

| Ürün Kodu | Fan Tipi | Besleme | Güç (W) | Nominal Akım | Gürültü Seviyesi | Kapasite | Adet | Fiyat |
|----------------|---------------------|------------------|---------|--------------|------------------|----------|------|-----------|
| 048 095 000200 | Ø172x163x51 AKSİYEL | 220V AC 50/60 Hz | 25/32W | 0,11/0,15A | 57 dB | 400 m³/h | 1 | 132,80 \$ |
| 048 095 000201 | Ø190x68 RADYAL | 220V AC 50/60 Hz | 58/75W | 0,26/0,34A | 62 dB | 560 m³/h | 1 | 199,30 \$ |
| 048 095 000202 | Ø220X71 RADYAL | 220V AC 50/60 Hz | 85/90W | 0,38/0,44A | 73 dB | 970 m³/h | 1 | 232,70 \$ |

EKOFAN SERİSİ TEPE FANLARI

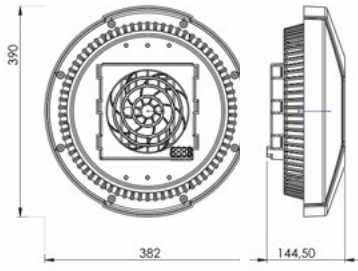

EKOFAN TEPE FANLARI

| Ürün Kodu | Fan Tipi | Besleme | Güç (W) | Nominal Akım | Gürültü Seviyesi | Kapasite | Adet | Fiyat (\$) |
|----------------|----------|---------------------|---------|--------------|------------------|-----------|------|------------|
| 048 095 100100 | MTF300 | 230V AC 50/60 Hz | 35W | 0,15A | 51 dB | 300 m³/h | 1 | 131,20 \$ |
| 048 095 100101 | MTF 600 | 230V AC 50/60 Hz | 65W | 0,30A | 60 dB | 634 m³/h | 1 | 159,30 \$ |
| 048 095 100102 | MTF 900 | 230V AC 50/60 Hz | 90W | 0,48A | 60 dB | 900 m³/h | 1 | 173,40 \$ |
| 048 095 100103 | MTF 1200 | 230V AC 50/60 Hz | 90W | 0,48A | 90 dB | 1200 m³/h | 1 | 187,40 \$ |



KOLAY MONTAJ FİLTRELER

| Ürün Kodu | Ölçü (mm) | Kesim Ölçüsü (mm) | Koruma Sınıfı | Adet / Koli | Fiyat (\$) |
|----------------|--------------|-------------------|---------------|-------------|------------|
| 048 095 000400 | 120x120x20,5 | 92x92 | IP54 | 200 | 6,89 \$ |
| 048 095 000401 | 160x160x31 | 125x125 | IP54 | 100 | 8,40 \$ |
| 048 095 000402 | 210x210x31 | 177x177 | IP54 | 100 | 13,30 \$ |
| 048 095 000403 | 260x260x31 | 223x223 | IP54 | 100 | 19,20 \$ |
| 048 095 000404 | 325x325x31 | 291x291 | IP54 | 100 | 33,20 \$ |



PROJE CEPLERİ

| Ürün Kodu | Ürün Adı | Adet / Koli | Fiyat (\$) |
|----------------|---------------|-------------|------------|
| 048 095 000902 | PROJE CEBİ A4 | 10 | 4,92 \$ |
| 048 095 000903 | PROJE CEBİ A5 | 10 | 3,90 \$ |

FİLTRELİ FANLAR



048 095 000500



048 095 000501



048 095 000502

| | | | |
|-------------------------------|----------------|----------------|----------------|
| ÜRÜN KODU | 048 095 000500 | 048 095 000501 | 048 095 000502 |
| ÖLÇÜ (mm) | 120x120x58,5 | 160x160x69 | 120x120x58,5 |
| KESİM ÖLÇÜSÜ (mm) | 92x92 | 125x125 | 92x92 |
| FAN TİPİ | 80x80x38 | 120x120x38 | 80x80x38 |
| BESLEME (V AC) | 230V-50/60Hz | 230V-50/60Hz | 230V-50/60Hz |
| GÜÇ (W) | 14 (13) | 26 (23) | 14 (13) |
| HIZ (rpm) | 2800 | 2700 | 2800 |
| FİLTRELİ (m ³ /h) | 30 | 100 | 30 |
| FİLTRESİZ (m ³ /h) | 41 | 140 | 41 |
| NOMİNAL AKIM | 0,08 / 0,07 | 0,14 / 0,13 | 0,8 / 0,7 |
| GÜRÜLTÜ SEVİYESİ (db) | 28 (31) | 42 (46) | 28 (31) |
| AD. / FİYAT | 39,90 \$ | 46,80 \$ | 46,80 \$ |



048 095 000600



048 095 000601



048 095 000602



048 095 000603

| | | | | |
|-------------------------------|----------------|----------------|----------------|----------------|
| ÜRÜN KODU | 048 095 000600 | 048 095 000601 | 048 095 000602 | 048 095 000603 |
| ÖLÇÜ (mm) | 160x160x69 | 210x210x98 | 210x210x83 | 260x260x103 |
| KESİM ÖLÇÜSÜ (mm) | 125x125 | 177x177 | 177x177 | 223x223 |
| FAN TİPİ | 120x120x38 | 120x120x38 | 173x163x51 | 120x120x38 |
| BESLEME (V AC) | 230V-50/60Hz | 230V-50/60Hz | 230V-50/60Hz | 230V-50/60Hz |
| GÜÇ (W) | 26 (23) | 26 (23) | 37 (35) | 26 (23) |
| HIZ (rpm) | 2700 | 2700 | 2400 | 2700 |
| FİLTRELİ (m ³ /h) | 100 | 125 | 175 | 115 |
| FİLTRESİZ (m ³ /h) | 140 | 175 | 245 | 130 |
| NOMİNAL AKIM | 0,14 / 0,13 | 0,14 / 0,13 | 0,23 / 0,22 | 0,14 / 0,13 |
| GÜRÜLTÜ SEVİYESİ (db) | 42 (46) | 42 (46) | 52 (53) | 42 (46) |
| AD. / FİYAT | 53,10 \$ | 73,80 \$ | 93,00 \$ | 79,70 \$ |



048 095 000604



048 095 000605



048 095 000606



048 095 000607

| | | | | |
|-------------------------------|----------------|----------------|----------------|----------------|
| ÜRÜN KODU | 048 095 000604 | 048 095 000605 | 048 095 000606 | 048 095 000607 |
| ÖLÇÜ (mm) | 260x260x116 | 260x260x111 | 325x325x145 | 325x325x111 |
| KESİM ÖLÇÜSÜ (mm) | 223x223 | 223x223 | 291x291 | 291x291 |
| FAN TİPİ | 172x1263x51 | 225x225x80 | 225x225x80 | 280x280x80 |
| BESLEME (V AC) | 230V-50/60Hz | 230V-50/60Hz | 230V-50/60Hz | 230V-50/60Hz |
| GÜÇ (W) | 37 (35) | 66 (75) | 66 (75) | 110 (140) |
| HIZ (rpm) | 2400 | 2600 | 2600 | 2600 |
| FİLTRELİ (m ³ /h) | 240 | 650 | 700 | 850 |
| FİLTRESİZ (m ³ /h) | 270 | 900 | 950 | 1200 |
| NOMİNAL AKIM | 0,23 / 0,22 | 0,35 / 0,38 | 0,35 / 0,38 | 0,50 / 0,72 |
| GÜRÜLTÜ SEVİYESİ (db) | 52 (53) | 60 (63) | 60 (63) | 65 (68) |
| AD. / FİYAT | 106,30 \$ | 265,70 \$ | 290,20 \$ | 299,10 \$ |



MINİ ISITICI



PTC ISITICI



SLİM ISITICI

PANO ISITICILARI

| Ürün Kodu | Ürün Adı | Besleme | Koruma Sınıfı | Ölçüler (AxBxC)mm | Bağlantı | Adet | Fiyat (\$) |
|----------------|------------------------------|----------------|---------------|-------------------|----------|------|------------|
| 048 095 000700 | 15W PTC PANO ISITICISI | 100-250V AC-DC | IP20 | 60x50x27 | KABLO | 1 | 43,50 \$ |
| 048 095 000701 | 25W PTC PANO ISITICISI | 100-250V AC-DC | IP20 | 70x50x27 | KABLO | 1 | 51,20 \$ |
| 048 095 000702 | 30W PTC PANO ISITICISI | 100-250V AC-DC | IP20 | 128x70x59 | KLEMENS | 1 | 64,00 \$ |
| 048 095 000703 | 50W PTC PANO ISITICISI | 100-250V AC-DC | IP20 | 138x70x59 | KLEMENS | 1 | 76,70 \$ |
| 048 095 000704 | 75W PTC PANO ISITICISI | 100-250V AC-DC | IP20 | 178x70x59 | KLEMENS | 1 | 121,50 \$ |
| 048 095 000705 | 100W PTC PANO ISITICISI | 100-250V AC-DC | IP20 | 188x70x59 | KLEMENS | 1 | 129,80 \$ |
| 048 095 000706 | 150W PTC PANO ISITICISI | 100-250V AC-DC | IP20 | 228x70x59 | KLEMENS | 1 | 147,10 \$ |
| 048 095 000707 | 30W SLIM PTC PANO ISITICISI | 100-250V AC-DC | IP20 | 128x27x80 | KLEMENS | 1 | 60,70 \$ |
| 048 095 000708 | 50W SLIM PTC PANO ISITICISI | 100-250V AC-DC | IP20 | 138x27x80 | KLEMENS | 1 | 69,10 \$ |
| 048 095 000709 | 75W SLIM PTC PANO ISITICISI | 100-250V AC-DC | IP20 | 178x27x80 | KLEMENS | 1 | 112,50 \$ |
| 048 095 000710 | 100W SLIM PTC PANO ISITICISI | 100-250V AC-DC | IP20 | 188x27x80 | KLEMENS | 1 | 120,90 \$ |
| 048 095 000711 | 150W SLIM PTC PANO ISITICISI | 100-250V AC-DC | IP20 | 228x27x80 | KLEMENS | 1 | 138,10 \$ |



FANLI PTC ISITICI



FANLI ISITICI



400W PLASTİK FANLI ISITICI

FANLI PANO ISITICILARI

| Ürün Kodu | Ürün Adı | Besleme | Koruma Sınıfı | Ölçüler (AxBxC)mm | Bağlantı | Adet | Fiyat (\$) |
|----------------|---------------------------------------|------------------|---------------|-------------------|----------|------|------------|
| 048 095 000800 | 100W FANLI PTC PANO ISITICISI | 230V AC 50/60 Hz | IP20 | 170x89x60 | KLEMENS | 1 | 172,70 \$ |
| 048 095 000801 | 150W FANLI PTC PANO ISITICISI | 230V AC 50/60 Hz | IP20 | 210x89x60 | KLEMENS | 1 | 241,70 \$ |
| 048 095 000802 | 250W FANLI REZİSTANS PANO ISITICISI | 230V AC 50/60 Hz | IP20 | 152x110x80 | KLEMENS | 1 | 259,00 \$ |
| 048 095 000803 | 500W FANLI REZİSTANS PANO ISITICISI | 230V AC 50/60 Hz | IP20 | 182x110x80 | KLEMENS | 1 | 294,20 \$ |
| 048 095 000804 | 750W FANLI REZİSTANS PANO ISITICISI | 230V AC 50/60 Hz | IP20 | 232x110x80 | KLEMENS | 1 | 337,00 \$ |
| 048 095 000805 | 200/300/400W FANLI PTC PANO ISITICISI | 230V AC 50/60 Hz | IP20 | 99x70x67 | KABLO | 1 | 301,80 \$ |



R-MEKS SERİSİ

X yerine Gri için 7, Siyah için 1 rakamını yazınız.

IP68 

| Ürün Kodu | Ürün Adı | Kablo Sıkma Çapı | Kutu Adet | Koli Adet | Fiyat (₺) | |
|---------------------------------------|----------------|----------------------|-----------|-----------|-----------|--------|
| R-MEKS PG PLASTİK KABLO RAKORU | | | | | | |
| 010 097 1X0007 | R-MEKS PG-7 | PLASTİK KABLO RAKORU | 3-6,5 mm | 450 | 4.500 | 9,24 |
| 010 097 1X0009 | R-MEKS PG-9 | PLASTİK KABLO RAKORU | 4-6 mm | 300 | 3.000 | 10,81 |
| 010 097 1X0011 | R-MEKS PG-11 | PLASTİK KABLO RAKORU | 5-10 mm | 200 | 2.000 | 13,40 |
| 010 097 1X0135 | R-MEKS PG-13,5 | PLASTİK KABLO RAKORU | 6-12 mm | 175 | 1750 | 14,60 |
| 010 097 1X0016 | R-MEKS PG-16 | PLASTİK KABLO RAKORU | 10-14 mm | 125 | 1250 | 18,11 |
| 010 097 1X0021 | R-MEKS PG-21 | PLASTİK KABLO RAKORU | 13-18 mm | 75 | 750 | 28,64 |
| 010 097 1X0029 | R-MEKS PG-29 | PLASTİK KABLO RAKORU | 18-25 mm | 40 | 400 | 52,21 |
| 010 097 1X0036 | R-MEKS PG-36 | PLASTİK KABLO RAKORU | 22-32 mm | 20 | 200 | 89,08 |
| 010 097 1X0042 | R-MEKS PG-42 | PLASTİK KABLO RAKORU | 32-38 mm | 15 | 150 | 109,59 |
| 010 097 1X0048 | R-MEKS PG-48 | PLASTİK KABLO RAKORU | 37-44 mm | 12 | 120 | 123,45 |

X yerine Gri için 7, Siyah için 1 rakamını yazınız.

IP68 

| Ürün Kodu | Ürün Adı | Kablo Sıkma Çapı | Kutu Adet | Koli Adet | Fiyat (₺) |
|---|--|------------------|-----------|-----------|-----------|
| R-MEKS METRİK PLASTİK KABLO RAKORU | | | | | |
| 010 097 1X0712 | R-MEKS M12X1,5 METRİK PLASTİK KABLO RAKORU (PG 7) | 3-6,5 mm | 450 | 4500 | 9,51 |
| 010 097 1X1112 | R-MEKS M16X1,5 METRİK PLASTİK KABLO RAKORU (PG 11) | 5-10 mm | 200 | 2000 | 13,55 |
| 010 097 1X1320 | R-MEKS M20X1,5 METRİK PLASTİK KABLO RAKORU (PG 13,5) | 6-12 mm | 175 | 1750 | 15,59 |
| 010 097 1X1620 | R-MEKS M20X1,5 METRİK PLASTİK KABLO RAKORU (PG 16) | 10-14 mm | 125 | 1250 | 18,55 |
| 010 097 1X2125 | R-MEKS M25X1,5 METRİK PLASTİK KABLO RAKORU (PG 21) | 13-18 mm | 75 | 750 | 29,43 |
| 010 097 1X2932 | R-MEKS M32X1,5 METRİK PLASTİK KABLO RAKORU (PG 29) | 18-25 mm | 40 | 400 | 61,87 |
| 010 097 1X3640 | R-MEKS M40X1,5 METRİK PLASTİK KABLO RAKORU (PG 36) | 22-32 mm | 20 | 200 | 100,60 |
| 010 097 1X4250 | R-MEKS M50X1,5 METRİK PLASTİK KABLO RAKOR (PG 42) | 32-38 mm | 15 | 150 | 129,07 |
| 010 097 1X4863 | R-MEKS M63X1,5 METRİK PLASTİK KABLO RAKORU (PG 48) | 37-44 mm | 12 | 120 | 156,15 |



R-MEKS SERİSİ



Bağlantılarınızı Güçlendirin

PG

METRİK

Her İhtiyaca Yönelik Kablo Rakorları



Promex Rakor

PLASTİK KABLO RAKORU

IP68 

| Ürün Kodu | Ürün Adı | Kablo Sıkma Çapı | Delik Çapı | Kutu Adet | Koli Adet | Fiyat (€) |
|--|---------------------------|------------------|------------|-----------|-----------|-----------|
| PROMEX SMART PLASTİK KABLO RAKORU | | | | | | |
| 057 097 411X16 | 16'LİK SMART KABLO RAKORU | 5-10 mm | 16 mm | 150 | 1350 | 0,9417 € |
| 057 097 412X20 | 20'LİK SMART KABLO RAKORU | 6-12 mm | 20 mm | 120 | 1080 | 0,9917 € |
| 057 097 422X25 | 25'LİK SMART KABLO RAKORU | 11-17 mm | 25 mm | 50 | 450 | 1,4310 € |
| 057 097 422X32 | 32'LİK SMART KABLO RAKORU | 15-21 mm | 32 mm | 40 | 360 | 2,4075 € |
| 057 097 422X40 | 40'LİK SMART KABLO RAKORU | 19-28 mm | 40 mm | 20 | 180 | 4,0320 € |



IP68 

| Ürün Kodu | Ürün Adı | Kablo Sıkma Çapı | Delik Çapı | Kutu Adet | Koli Adet | Fiyat (€) |
|---------------------------------------|------------------------------|------------------|------------|-----------|-----------|-----------|
| PROMEX PG PLASTİK KABLO RAKORU | | | | | | |
| 057 097 211X07 | PG 7 PLASTİK KABLO RAKORU | 3-6.5 mm | 13 | 450 | 4050 | 0,3007 € |
| 057 097 212X09 | PG 9 PLASTİK KABLO RAKORU | 4-8 mm | 15,5 | 300 | 2700 | 0,3153 € |
| 057 097 213X11 | PG 11 PLASTİK KABLO RAKORU | 5-10 mm | 19 | 200 | 1800 | 0,3740 € |
| 057 097 214X14 | PG 13,5 PLASTİK KABLO RAKORU | 6-12 mm | 20,5 | 175 | 1575 | 0,4253 € |
| 057 097 215X16 | PG 16 PLASTİK KABLO RAKORU | 10-14 mm | 22,5 | 125 | 1125 | 0,4921 € |
| 057 097 216X21 | PG 21 PLASTİK KABLO RAKORU | 13-18 mm | 28,5 | 75 | 675 | 0,7764 € |
| 057 097 217X29 | PG 29 PLASTİK KABLO RAKORU | 18-25 mm | 37,5 | 40 | 360 | 1,4156 € |
| 057 097 218X36 | PG 36 PLASTİK KABLO RAKORU | 22-32 mm | 47,5 | 20 | 180 | 2,4058 € |
| 057 097 219X42 | PG 42 PLASTİK KABLO RAKORU | 30-38 mm | 54,5 | 15 | 135 | 2,9592 € |
| 057 097 220X48 | PG 48 PLASTİK KABLO RAKORU | 34-44 mm | 60,5 | 12 | 108 | 3,3447 € |



IP68 

| Ürün Kodu | Ürün Adı | Kablo Sıkma Çapı | Delik Çapı (Diş Çekilmiş) | Delik Çapı (Diş Çekme) | Kutu Adedi | Koli Adedi | Fiyat (€) |
|---|------------------------------|------------------|---------------------------|------------------------|------------|------------|-----------|
| PROMEX METRİK PLASTİK KABLO RAKORU | | | | | | | |
| 057 097 310X12 | M12x1,5 METRİK PLASTİK RAKOR | 3-6,5 mm | 12 mm | 10,5 mm | 450 | 4050 | 0,3923 € |
| 057 097 311X16 | M16x1,5 METRİK PLASTİK RAKOR | 5-10 mm | 16 mm | 14,5 mm | 200 | 1800 | 0,3800 € |
| 057 097 312X20 | M20x1,5 METRİK PLASTİK RAKOR | 6-12 mm | 20 mm | 18,5 mm | 175 | 1575 | 0,4294 € |
| 057 097 313X20 | M20x1,5 METRİK PLASTİK RAKOR | 10-14 mm | 20 mm | 18,5 mm | 125 | 1125 | 0,5358 € |
| 057 097 314X20 | M20x1,5 METRİK PLASTİK RAKOR | 10-14 mm | 20 mm | 18,5 mm | 125 | 1125 | 0,5386 € |
| 057 097 315X25 | M25x1,5 METRİK PLASTİK RAKOR | 13-18 mm | 25 mm | 23,5 mm | 75 | 675 | 0,7897 € |
| 057 097 316X25 | M25x1,5 METRİK PLASTİK RAKOR | 13-18 mm | 25 mm | 23,5 mm | 75 | 675 | 0,8400 € |
| 057 097 317X32 | M32x1,5 METRİK PLASTİK RAKOR | 18-25 mm | 32 mm | 30,5 mm | 40 | 360 | 1,6680 € |
| 057 097 318X40 | M40x1,5 METRİK PLASTİK RAKOR | 22-32 mm | 40 mm | 38,5 mm | 20 | 180 | 2,6535 € |
| 057 097 319X50 | M50x1,5 METRİK PLASTİK RAKOR | 30-38 mm | 50 mm | 48,5 mm | 15 | 135 | 3,4937 € |
| 057 097 320X63 | M63x1,5 METRİK PLASTİK RAKOR | 34-44 mm | 63 mm | 61,5 mm | 12 | 108 | 3,9947 € |



Bu ürün kodlarında **X** ürün rengini belirtmektedir.

Sipariş vereceğiniz zaman ürün kodunda **X** yazan yere aşağıdaki renk kodlarından bir tanesini yazmanız gerekir.

0 = Açık gri

1 = Siyah

3 = Gri

* Smart rakorların çıkartma somunları harici olarak satılmaktadır.



Promex Rakorlar Hakkında
Daha Fazla Bilgi İçin

YENİ Promex Rakor

PLASTİK KABLO RAKORU



| Ürün Kodu | Ürün Adı | Kablo Sıkma Çapı | Diş Boyu | Kutu Adet | Koli Adet | Fiyat |
|---|---------------------------------------|------------------|----------|-----------|-----------|----------|
| PROMEX PLASTİK SİRAL RAKORLAR(GRİ) | | | | | | |
| 057 097 601007 | PROMEX PG-7 SİRAL UÇLU RAKOR (GRİ) | 3,00-6,50 | 8 mm | 100 | 2500 | 0,9361 € |
| 057 097 602009 | PROMEX PG-9 SİRAL UÇLU RAKOR (GRİ) | 4,00-8,00 | 8 mm | 50 | 1500 | 1,1301 € |
| 057 097 603011 | PROMEX PG-11 SİRAL UÇLU RAKOR(GRİ) | 5,00-10,00 | 8 mm | 50 | 1500 | 1,2524 € |
| 057 097 604014 | PROMEX PG-13,5 SİRAL UÇLU RAKOR (GRİ) | 6,00-12,00 | 10 mm | 50 | 1000 | 1,4463 € |
| 057 097 605016 | PROMEX PG-16 SİRAL UÇLU RAKOR(GRİ) | 10,00-14,00 | 10 mm | 50 | 500 | 1,4843 € |
| 057 097 606021 | PROMEX PG-21 SİRAL UÇLU RAKOR(GRİ) | 13,00-18,00 | 11 mm | 25 | 250 | 2,1336 € |



| Ürün Kodu | Ürün Adı | Kutu Adet | Koli Adet | Fiyat |
|---|--|-----------|-----------|-----------|
| PROMEX HAVALANDIRMA TAPASI PLASTİK | | | | |
| 057 097 701006 | PROMEX M6X0,75 HAVALANDIRMA TAPASI PLASTİK (GRİ) | 100 | 10000 | 3,0149 € |
| 057 097 702008 | PROMEX M8X1,0 HAVALANDIRMA TAPASI PLASTİK (GRİ) | 100 | 5000 | 3,1541 € |
| 057 097 703012 | PROMEX M12x1,5 HAVALANDIRMA TAPASI PLASTİK (GRİ) | 100 | 3000 | 3,386 € |
| 057 097 704016 | PROMEX M16X1,5 HAVALANDIRMA TAPASI PLASTİK (GRİ) | 100 | 1000 | 4,6383 € |
| 057 097 705020 | PROMEX M20X1,5 HAVALANDIRMA TAPASI PLASTİK (GRİ) | 100 | 1000 | 5,1949 € |
| 057 097 706040 | PROMEX M40X1,5 HAVALANDIRMA TAPASI PLASTİK (GRİ) | 50 | 200 | 16,9299 € |



| Ürün Kodu | Ürün Adı | Kablo Sıkma Çapı | Diş Boyu | Kutu Adet | Koli Adet | Fiyat |
|------------------------------|---|------------------|----------|-----------|-----------|-----------|
| PROMEX METAL RAKORLAR | | | | | | |
| 057 097 101007 | PROMEX PG 7 METAL RAKOR TL6 | 3,00-6,5 | 6 mm | 50 | 1000 | 2,0409 € |
| 057 097 102009 | PROMEX PG 9 METAL RAKOR TL6 | 4,00-8,00 | 6 mm | 50 | 900 | 2,5637 € |
| 057 097 103011 | PROMEX PG 11 METAL RAKOR TL6 | 5,00-10,00 | 6 mm | 50 | 600 | 3,2342 € |
| 057 097 104014 | PROMEX PG 13,5 METAL RAKOR TL6,5 | 6,00-12,00 | 6,5 mm | 50 | 500 | 3,6769 € |
| 057 097 105016 | PROMEX PG 16 METAL RAKOR TL6,5 | 10,00-14,00 | 6,5 mm | 50 | 400 | 4,2588 € |
| 057 097 106021 | PROMEX PG 21 METAL RAKOR TL7,2 | 13,00-18,00 | 7,2 mm | 25 | 200 | 6,9786 € |
| 057 097 107029 | PROMEX PG 29 METAL RAKOR TL8 | 18,00-25,00 | 8 mm | 10 | 100 | 14,3831 € |
| 057 097 108036 | PROMEX PG 36 METAL RAKOR TL9 | 22,00-32,00 | 9 mm | 5 | 50 | 22,9808 € |
| 057 097 109042 | PROMEX PG 42 METAL RAKOR TL12 | 30,00-38,00 | 12 mm | 5 | 40 | 34,952 € |
| 057 097 111048 | PROMEX PG 48 METAL RAKOR TL14 | 34,00-44,00 | 14 mm | 5 | 40 | 41,7028 € |
| 057 097 101107 | PROMEX M12x1.5 METAL RAKOR (PG7) TL6 | 3,00-6,50 | 6 mm | 50 | 1000 | 2,2433 € |
| 057 097 101109 | PROMEX M16x1.5 METAL RAKOR (PG9) TL7 | 4,00-8,00 | 7 mm | 50 | 900 | 2,7619 € |
| 057 097 101114 | PROMEX M20x1.5 METAL RAKOR (PG13.5) TL8 | 6,00-12,00 | 8 mm | 50 | 500 | 3,6769 € |
| 057 097 101116 | PROMEX M25x1.5 METAL RAKOR (PG16) TL8 | 13,00-18,00 | 8 mm | 25 | 350 | 5,6925 € |
| 057 097 101121 | PROMEX M32x1.5 METAL RAKOR (PG21) TL9 | 18,00-25,00 | 9 mm | 10 | 200 | 9,361 € |
| 057 097 101129 | PROMEX M40x1.5 METAL RAKOR (PG29) TL9 | 22,00-32,00 | 9 mm | 10 | 100 | 15,9559 € |
| 057 097 101136 | PROMEX M50x1.5 METAL RAKOR (PG36) TL9 | 34,00-44,00 | 9 mm | 5 | 50 | 26,4174 € |
| 057 097 101148 | PROMEX M63x1.5 METAL RAKOR (PG48) TL14 | 34,00-44,00 | 14 mm | 5 | 40 | 47,2435 € |



| Ürün Kodu | Ürün Adı | Kablo Sıkma Çapı | Diş Boyu | Kutu Adet | Koli Adet | Fiyat |
|---|---|------------------|----------|-----------|-----------|-----------|
| PROMEX PLASTİK VE METAL HAVALANDIRMA RAKORLARI | | | | | | |
| 057 097 801012 | PROMEX M12X1,5 HAVALANDIRMA RAKOR PLASTİK (GRİ) | 4,00-7,00 | 8 mm | 100 | 2000 | 3,0149 € |
| 057 097 801016 | PROMEX M16X1,5 HAVALANDIRMA RAKOR PLASTİK (GRİ) | 4,00-7,00 | 10 mm | 50 | 2000 | 3,2468 € |
| 057 097 801020 | PROMEX M20X1,5 HAVALANDIRMA RAKOR PLASTİK (GRİ) | 6,00-11,00 | 10 mm | 50 | 1500 | 3,7107 € |
| 057 097 802009 | PROMEX PG 9 HAVALANDIRMA RAKOR PLASTİK (GRİ) | 4,00-7,00 | 8 mm | 50 | 2000 | 3,0149 € |
| 057 097 802011 | PROMEX PG 11 HAVALANDIRMA RAKOR PLASTİK (GRİ) | 4,00-7,00 | 8 mm | 50 | 2000 | 3,2468 € |
| 057 097 802014 | PROMEX PG 13,5 HAVALANDIRMA RAKOR PLASTİK (GRİ) | 6,00-11,00 | 9 mm | 50 | 1500 | 3,7107 € |
| 057 097 803012 | PROMEX M12X1,5 HAVALANDIRMA RAKOR METAL | 2,00-6,00 | 8 mm | 50 | 1000 | 10,6682 € |
| 057 097 803016 | PROMEX M16X1,5 HAVALANDIRMA RAKOR METAL | 4,00-7,00 | 8 mm | 50 | 900 | 11,5958 € |
| 057 097 803020 | PROMEX M20X1,5 HAVALANDIRMA RAKOR METAL | 6,00-11,00 | 8 mm | 50 | 500 | 14,6571 € |
| 057 097 804007 | PROMEX PG 7 HAVALANDIRMA RAKORU METAL | 2,00-6,00 | 8 mm | 50 | 1000 | 10,6682 € |
| 057 097 804009 | PROMEX PG 9 HAVALANDIRMA RAKORU METAL | 4,00-7,00 | 8 mm | 50 | 900 | 11,5958 € |
| 057 097 804011 | PROMEX PG 11 HAVALANDIRMA RAKORU METAL | 5,00-9,00 | 8 mm | 50 | 600 | 14,5475 € |
| 057 097 804014 | PROMEX PG 13,5 HAVALANDIRMA RAKORU METAL | 6,00-11,0 | 9 mm | 50 | 500 | 16,2342 € |



“Her Bağlantıda; KALİTE”

POLYAMİD SİRAL RAKORLARI



| Ürün Kodu | Ürün Adı | Kutu Adet | Koli Adet | Fiyat (₺) |
|--|-----------------------------------|-----------|-----------|-----------|
| POLYAMİD SİRAL RAKORU X yerine Gri için 7, Siyah için 1 rakamını yazınız. | | | | |
| 057 097 1X0007 | PSR-7 SİRAL RAKORU (GRİ-SİYAH) | 50 ad. | | 0,57 € |
| 057 097 1X0009 | PSR-9 SİRAL RAKORU (GRİ-SİYAH) | 50 ad. | | 0,57 € |
| 057 097 1X0011 | PSR-11 SİRAL RAKORU (GRİ-SİYAH) | 50 ad. | | 0,60 € |
| 057 097 1X0135 | PSR-13,5 SİRAL RAKORU (GRİ-SİYAH) | 50 ad. | | 0,69 € |
| 057 097 1X0016 | PSR-16 SİRAL RAKORU (GRİ-SİYAH) | 50 ad. | | 0,74 € |
| 057 097 1X0021 | PSR-21 SİRAL RAKORU (GRİ-SİYAH) | 25 ad. | | 1,03 € |
| 057 097 1X0029 | PSR-29 SİRAL RAKORU (GRİ-SİYAH) | 20 ad. | | 1,71 € |
| 057 097 1X0036 | PSR-36 SİRAL RAKORU (GRİ-SİYAH) | 10 ad. | | 2,40 € |
| 057 097 1X0048 | PSR-48 SİRAL RAKORU (GRİ-SİYAH) | 1 ad. | | 3,29 € |

METRİK POLYAMİD SİRAL RAKORU

| | | | | |
|----------------|--|--------|--|--------|
| 057 097 111012 | M12X1.5 (PSR-7) POLYAMİD SİRAL RAKORU (SİYAH) | 50 ad. | | 0,57 € |
| 057 097 111016 | M16X1.5 (PSR-9) POLYAMİD SİRAL RAKORU (SİYAH) | 50 ad. | | 0,57 € |
| 057 097 111018 | M18X1.5 (PSR-11) POLYAMİD SİRAL RAKORU (SİYAH) | 50 ad. | | 0,60 € |
| 057 097 111020 | M20X1.5 (PSR-13,5) POLYAMİD SİRAL RAKORU (SİYAH) | 50 ad. | | 0,69 € |
| 057 097 111025 | M25X1.5 (PSR-16) POLYAMİD SİRAL RAKORU (SİYAH) | 50 ad. | | 0,74 € |
| 057 097 111125 | M25X1.5 (PSR-21) POLYAMİD SİRAL RAKORU (SİYAH) | 25 ad. | | 1,03 € |
| 057 097 111032 | M32X1.5 (PSR-29) POLYAMİD SİRAL RAKORU (SİYAH) | 20 ad. | | 1,71 € |
| 057 097 111040 | M40X1.5 (PSR-36) POLYAMİD SİRAL RAKORU (SİYAH) | 10 ad. | | 2,40 € |
| 057 097 111050 | M50X1.5 (PSR-48) POLYAMİD SİRAL RAKORU (SİYAH) | 1 ad. | | 3,29 € |

POLYAMİD SİRAL DİRSEĞİ

 X yerine Gri için 7, Siyah için 0 rakamını yazınız.

| | | | | |
|----------------|---|-------|--|--------|
| 057 097 12X007 | PSRD-7 SİRAL RAKORU 90° DİRSEK (GRİ-SİYAH) | 1 ad. | | 1,20 € |
| 057 097 12X009 | PSRD-9 SİRAL RAKORU 90° DİRSEK (GRİ-SİYAH) | 1 ad. | | 1,28 € |
| 057 097 12X011 | PSRD-11 SİRAL RAKORU 90° DİRSEK (GRİ-SİYAH) | 1 ad. | | 1,41 € |
| 057 097 12X135 | PSRD-13,5 SİRAL RAKORU 90° DİRSEK (GRİ-SİYAH) | 1 ad. | | 1,67 € |
| 057 097 12X016 | PSRD-16 SİRAL RAKORU 90° DİRSEK (GRİ-SİYAH) | 1 ad. | | 1,93 € |
| 057 097 12X021 | PSRD-21 SİRAL RAKORU 90° DİRSEK (GRİ-SİYAH) | 1 ad. | | 3,08 € |

POLYAMİD SİRAL KROŞELERİ

 €€

| | | | | |
|----------------|--|--------|--|--------|
| 057 097 160007 | PG-7 POLYAMİD SİRAL KROŞESİ (GRİ-SİYAH) | 50 ad. | | 0,63 € |
| 057 097 160009 | PG-9 POLYAMİD SİRAL KROŞESİ (GRİ-SİYAH) | 50 ad. | | 0,63 € |
| 057 097 160011 | PG-11 POLYAMİD SİRAL KROŞESİ (GRİ-SİYAH) | 50 ad. | | 0,63 € |
| 057 097 160135 | PG-13,5 POLYAMİD SİRAL KROŞESİ (GRİ-SİYAH) | 50 ad. | | 0,67 € |
| 057 097 160016 | PG-16 POLYAMİD SİRAL KROŞESİ (GRİ-SİYAH) | 50 ad. | | 0,72 € |
| 057 097 160021 | PG-21 POLYAMİD SİRAL KROŞESİ (GRİ-SİYAH) | 25 ad. | | 0,81 € |
| 057 097 160029 | PG-29 POLYAMİD SİRAL KROŞESİ (GRİ-SİYAH) | 25 ad. | | 1,52 € |
| 057 097 160036 | PG-36 POLYAMİD SİRAL KROŞESİ (GRİ-SİYAH) | 25 ad. | | 2,33 € |
| 057 097 160048 | PG-48 POLYAMİD SİRAL KROŞESİ (GRİ-SİYAH) | 10 ad. | | 3,24 € |

SÜPER ETANJ PLASTİK RAKORLAR

 €€

| | | | | |
|----------------|-----------------------|---------|------|--------|
| 010 097 000007 | PG-7 PLASTİK RAKOR | 450 ad. | 4500 | 9,60 |
| 010 097 000009 | PG-9 PLASTİK RAKOR | 300 ad. | 3000 | 11,30 |
| 010 097 000011 | PG-11 PLASTİK RAKOR | 200 ad. | 2000 | 12,80 |
| 010 097 000135 | PG-13,5 PLASTİK RAKOR | 175 ad. | 1750 | 14,00 |
| 010 097 000016 | PG-16 PLASTİK RAKOR | 125 ad. | 1250 | 17,60 |
| 010 097 000021 | PG-21 PLASTİK RAKOR | 75 ad. | 750 | 24,30 |
| 010 097 000029 | PG-29 PLASTİK RAKOR | 40 ad. | 400 | 38,70 |
| 010 097 000036 | PG-36 PLASTİK RAKOR | 20 ad. | 200 | 75,60 |
| 010 097 000042 | PG-42 PLASTİK RAKOR | 15 ad. | 150 | 93,10 |
| 010 097 000048 | PG-48 PLASTİK RAKOR | 12 ad. | 120 | 107,20 |



010 097 000016

010 097 000029

X yerine Gri için 7, Siyah için 1 rakamını yazınız.

YENİ

UV
KORUMA



| Ürün Kodu | Ürün Adı | Kutu Adet | Koli Adet | Fiyat (₺) |
|-----------|----------|-----------|-----------|-----------|
|-----------|----------|-----------|-----------|-----------|

SUNFLEX POLYAMİD SİRAL BORU (UV DAYANIMLI)

| Ürün Kodu | Ürün Adı | Rakor Ölçüsü | Ort. İç Çap | | Kutu Adet | Koli Adet | Fiyat (₺) |
|----------------------|---------------------------------------|--------------|-------------|--------------|-----------|-----------|-----------|
| | | | Ort. İç Çap | Ort. Dış Çap | | | |
| 001 020 180007 00 XX | Ø7 POLYAMİD SİRAL BORU(UV DAYANIMI) | PSR7 | 7 | 10,1 | 100 mt. | 1000 | 15,37 |
| 001 020 180009 00 XX | Ø8,5 POLYAMİD SİRAL BORU(UV DAYANIMI) | | 8,4 | 12,05 | 100 mt. | 1000 | 16,59 |
| 001 020 180010 00 XX | Ø10 POLYAMİD SİRAL BORU(UV DAYANIMLI) | PSR9 | 10,2 | 13,1 | 100 mt. | 1000 | 18,09 |
| 001 020 180012 00 XX | Ø12 POLYAMİD SİRAL BORU(UV DAYANIMLI) | PSR11 | 12,3 | 15,9 | 50 mt. | 500 | 27,09 |
| 001 020 180014 00 XX | Ø14 POLYAMİD SİRAL BORU(UV DAYANIMLI) | PSR13,5 | 14,1 | 18,35 | 50 mt. | 250 | 32,58 |
| 001 020 180017 00 XX | Ø17 POLYAMİD SİRAL BORU(UV DAYANIMLI) | PSR16 | 17 | 21,45 | 50 mt. | 250 | 39,16 |
| 001 020 180019 00 XX | Ø19 POLYAMİD SİRAL BORU(UV DAYANIMLI) | | 19 | 24,25 | 50 mt. | 250 | 47,69 |
| 001 020 180023 00 XX | Ø23 POLYAMİD SİRAL BORU(UV DAYANIMLI) | PSR21 | 23,25 | 28,5 | 50 mt. | 250 | 53,21 |
| 001 020 180026 00 XX | Ø26 POLYAMİD SİRAL BORU(UV DAYANIMLI) | | 26,2 | 31,3 | 25 mt. | 125 | 60,62 |
| 001 020 180029 00 XX | Ø29 POLYAMİD SİRAL BORU(UV DAYANIMLI) | PSR29 | 29,1 | 34,3 | 25 mt. | 125 | 67,33 |
| 001 020 180036 00 XX | Ø36 POLYAMİD SİRAL BORU(UV DAYANIMLI) | PSR36 | 36,2 | 42,2 | 25 mt. | 125 | 93,61 |
| 001 020 180048 00 XX | Ø48 POLYAMİD SİRAL BORU(UV DAYANIMLI) | PSR48 | 48,5 | 54,5 | 25 mt. | 125 | 127,76 |

PA6 POLYAMİD SİRALER (ALEV YAYMAYAN)

| | | | | | | | |
|----------------------|---------------------------|---------|-------|-------|---------|------|--------|
| 001 020 170007 00 XX | MUT/PA6-7 (A. YAYMAYAN) | PSR7 | 7 | 10,1 | 100 mt. | 1000 | 12,63 |
| 001 020 170009 00 XX | MUT/PA6-8,5 (A. YAYMAYAN) | | 8,4 | 12,05 | 100 mt. | 1000 | 13,58 |
| 001 020 170010 00 XX | MUT/PA6-10 (A. YAYMAYAN) | PSR9 | 10,2 | 13,1 | 100 mt. | 1000 | 14,78 |
| 001 020 170012 00 XX | MUT/PA6-12 (A. YAYMAYAN) | PSR11 | 12,3 | 15,9 | 50 mt. | 500 | 21,96 |
| 001 020 170014 00 XX | MUT/PA6-14 (A. YAYMAYAN) | PSR13,5 | 14,1 | 18,35 | 50 mt. | 250 | 26,22 |
| 001 020 170017 00 XX | MUT/PA6-17 (A. YAYMAYAN) | PSR16 | 17 | 21,45 | 50 mt. | 250 | 31,41 |
| 001 020 170019 00 XX | MUT/PA6-19 (A. YAYMAYAN) | | 19 | 24,25 | 50 mt. | 250 | 38,06 |
| 001 020 170023 00 XX | MUT/PA6-23 (A. YAYMAYAN) | PSR21 | 23,25 | 28,5 | 50 mt. | 250 | 42,54 |
| 001 020 170026 00 XX | MUT/PA6-26 (A. YAYMAYAN) | | 26,2 | 31,3 | 25 mt. | 125 | 48,51 |
| 001 020 170029 00 XX | MUT/PA6-29 (A. YAYMAYAN) | PSR29 | 29,1 | 34,3 | 25 mt. | 125 | 55,59 |
| 001 020 170036 00 XX | MUT/PA6-36 (A. YAYMAYAN) | PSR36 | 36,2 | 42,2 | 25 mt. | 125 | 93,88 |
| 001 020 170048 00 XX | MUT/PA6-48 (A. YAYMAYAN) | PSR48 | 48,5 | 54,5 | 25 mt. | 125 | 107,86 |

POLİPROPİLEN SİRAL BORU

| | | | | | | | |
|----------------------|--------------------------|---------|-------|-------|---------|------|-------|
| 001 020 160007 00 XX | MUT/PP-7 PP SİRAL BORU | PSR7 | 7 | 10,1 | 100 mt. | 1000 | 8,13 |
| 001 020 160009 00 XX | MUT/PP-8,5 PP SİRAL BORU | | 8,4 | 12,05 | 100 mt. | 1000 | 8,66 |
| 001 020 160010 00 XX | MUT/PP-10 PP SİRAL BORU | PSR9 | 10,2 | 13,1 | 100 mt. | 1000 | 9,43 |
| 001 020 160012 00 XX | MUT/PP-12 PP SİRAL BORU | PSR11 | 12,3 | 15,9 | 50 mt. | 500 | 13,01 |
| 001 020 160014 00 XX | MUT/PP-14 PP SİRAL BORU | PSR13,5 | 14,1 | 18,35 | 50 mt. | 250 | 15,63 |
| 001 020 160017 00 XX | MUT/PP-17 PP SİRAL BORU | PSR16 | 17 | 21,45 | 50 mt. | 250 | 19,20 |
| 001 020 160019 00 XX | MUT/PP-19 PP SİRAL BORU | | 19 | 24,25 | 50 mt. | 250 | 21,30 |
| 001 020 160023 00 XX | MUT/PP-23 PP SİRAL BORU | PSR21 | 23,25 | 28,5 | 50 mt. | 250 | 23,72 |
| 001 020 160026 00 XX | MUT/PP-26 PP SİRAL BORU | | 26,2 | 31,3 | 25 mt. | 125 | 26,22 |
| 001 020 160029 00 XX | MUT/PP-29 PP SİRAL BORU | PSR29 | 29,1 | 34,3 | 25 mt. | 125 | 28,83 |
| 001 020 160036 00 XX | MUT/PP-36 PP SİRAL BORU | PSR36 | 35,8 | 42,2 | 25 mt. | 125 | 44,14 |
| 001 020 160048 00 XX | MUT/PP-48 PP SİRAL BORU | PSR48 | 48,5 | 54,5 | 25 mt. | 125 | 54,78 |

POLYAMİD YARIKLI SİRAL BORU (ALEV YAYMAYAN)

| | | | | | | | |
|----------------------|---|--|--|--|---------|------|--------|
| 001 020 470007 00 XX | Ø7 POLYAMİD YARIKLI SİRAL BORU(ALEV YAYMAYAN) | | | | 100 mt. | 1000 | 13,52 |
| 001 020 470009 00 XX | Ø8,5 POLYAMİD YARIKLI SİRAL BORU(ALEV YAYMAYAN) | | | | 100 mt. | 1000 | 14,53 |
| 001 020 470010 00 XX | Ø10 POLYAMİD YARIKLI SİRAL BORU(ALEV YAYMAYAN) | | | | 100 mt. | 1000 | 15,82 |
| 001 020 470012 00 XX | Ø12 POLYAMİD YARIKLI SİRAL BORU(ALEV YAYMAYAN) | | | | 100 mt. | 500 | 23,49 |
| 001 020 470014 00 XX | Ø14 POLYAMİD YARIKLI SİRAL BORU(ALEV YAYMAYAN) | | | | 50 mt. | 250 | 28,06 |
| 001 020 470017 00 XX | Ø17 POLYAMİD YARIKLI SİRAL BORU(ALEV YAYMAYAN) | | | | 50 mt. | 250 | 33,52 |
| 001 020 470019 00 XX | Ø19 POLYAMİD YARIKLI SİRAL BORU(ALEV YAYMAYAN) | | | | 50 mt. | 250 | 41,60 |
| 001 020 470023 00 XX | Ø23 POLYAMİD YARIKLI SİRAL BORU(ALEV YAYMAYAN) | | | | 50 mt. | 250 | 46,12 |
| 001 020 470026 00 XX | Ø26 POLYAMİD YARIKLI SİRAL BORU(ALEV YAYMAYAN) | | | | 25 mt. | 125 | 51,90 |
| 001 020 470029 00 XX | Ø29 POLYAMİD YARIKLI SİRAL BORU(ALEV YAYMAYAN) | | | | 25 mt. | 125 | 58,12 |
| 001 020 470036 00 XX | Ø36 POLYAMİD YARIKLI SİRAL BORU(ALEV YAYMAYAN) | | | | 25 mt. | 125 | 97,60 |
| 001 020 470048 00 XX | Ø48 POLYAMİD YARIKLI SİRAL BORU(ALEV YAYMAYAN) | | | | 25 mt. | 125 | 112,78 |

KABLO BAĞLARI

Kendinden Kilitlemeli Sistem
Kolay ve Hızlı Montaj
1.Sınıf Malzeme



| Siyah Ürün Kodu | Ürün Adı | Kutu Adet | Koli Adet | Fiyat (₺) |
|----------------------------|--------------------|-----------|-----------|-----------|
| YENİ 062 129 225100 | 2,5x100 KABLO BAĞI | 1000 ad. | 60.000 | 0,2855 |
| 062 129 225140 | 2,5x140 KABLO BAĞI | 100 ad. | 35.000 | 0,4253 |
| 062 129 225200 | 2,5x200 KABLO BAĞI | 100 ad. | 25.000 | 0,6175 |
| 062 129 236150 | 3,6x150 KABLO BAĞI | 100 ad. | 25.000 | 0,7282 |
| 062 129 236205 | 3,6x205 KABLO BAĞI | 100 ad. | 20.000 | 0,9904 |
| 062 129 236250 | 3,6x250 KABLO BAĞI | 100 ad. | 20.000 | 1,171 |
| 062 129 236300 | 3,6x300 KABLO BAĞI | 100 ad. | 15.000 | 1,4856 |
| 062 129 236370 | 3,6x370 KABLO BAĞI | 100 ad. | 12.000 | 1,8701 |
| 062 129 248200 | 4,8x200 KABLO BAĞI | 100 ad. | 12.000 | 1,439 |
| 062 129 248250 | 4,8x250 KABLO BAĞI | 100 ad. | 12.000 | 1,6779 |
| 062 129 248300 | 4,8x300 KABLO BAĞI | 100 ad. | 11.000 | 2,109 |
| 062 129 248350 | 4,8x350 KABLO BAĞI | 100 ad. | 9.000 | 2,4411 |
| 062 129 248400 | 4,8x400 KABLO BAĞI | 100 ad. | 8.000 | 2,779 |
| 062 129 248450 | 4,8x450 KABLO BAĞI | 100 ad. | 6.000 | 3,3091 |
| 062 129 208250 | 8x250 KABLO BAĞI | 100 ad. | 6.000 | 3,3557 |
| 062 129 208300 | 8x300 KABLO BAĞI | 100 ad. | 5.000 | 4,4568 |
| 062 129 208380 | 8x380 KABLO BAĞI | 100 ad. | 5.000 | 4,7947 |
| 062 129 208450 | 8x450 KABLO BAĞI | 100 ad. | 3.500 | 5,3657 |
| 062 129 208550 | 8x550 KABLO BAĞI | 100 ad. | 3.000 | 7,1892 |
| 062 129 208750 | 8x750 KABLO BAĞI | 100 ad. | 2.000 | 11,5004 |
| 062 129 209762 | 9x762 KABLO BAĞI | 100 ad. | 1.500 | 15,3338 |
| 062 129 209940 | 9x940 KABLO BAĞI | 100 ad. | 1.500 | 17,7283 |

| Beyaz Ürün Kodu | Siyah Ürün Kodu | Ürün Adı | Kutu Adet | Koli Adet | Fiyat (₺) |
|---|-----------------|--------------------|-----------|-----------|-----------|
| MUTLUSAN KABLO BAĞLARI (SİYAH-BEYAZ) | | | | | |
| 062 129 025100 | 062 129 125100 | 2,5x100 KABLO BAĞI | 1000 ad. | 60.000 | 0,2494 |
| 062 129 025140 | 062 129 125140 | 2,5x140 KABLO BAĞI | 100 ad. | 35.000 | 0,3717 |
| 062 129 025200 | 062 129 125200 | 2,5x200 KABLO BAĞI | 100 ad. | 25.000 | 0,5364 |
| 062 129 036150 | 062 129 136150 | 3,6x150 KABLO BAĞI | 100 ad. | 25.000 | 0,6353 |
| 062 129 036205 | 062 129 136205 | 3,6x205 KABLO BAĞI | 100 ad. | 20.000 | 0,8658 |
| 062 129 036250 | 062 129 136250 | 3,6x250 KABLO BAĞI | 100 ad. | 20.000 | 1,0211 |
| 062 129 036300 | 062 129 136300 | 3,6x300 KABLO BAĞI | 100 ad. | 15.000 | 1,2940 |
| 062 129 036370 | 062 129 136370 | 3,6x370 KABLO BAĞI | 100 ad. | 12.000 | 1,6328 |
| 062 129 048200 | 062 129 148200 | 4,8x200 KABLO BAĞI | 100 ad. | 12.000 | 1,2564 |
| 062 129 048250 | 062 129 148250 | 4,8x250 KABLO BAĞI | 100 ad. | 12.000 | 1,4634 |
| 062 129 048300 | 062 129 148300 | 4,8x300 KABLO BAĞI | 100 ad. | 11.000 | 1,8399 |
| 062 129 048350 | 062 129 148350 | 4,8x350 KABLO BAĞI | 100 ad. | 9.000 | 2,1316 |
| 062 129 048400 | 062 129 148400 | 4,8x400 KABLO BAĞI | 100 ad. | 8.000 | 2,4234 |
| 062 129 048450 | 062 129 148450 | 4,8x450 KABLO BAĞI | 100 ad. | 6.000 | 2,8845 |
| 062 129 008250 | 062 129 108250 | 8x250 KABLO BAĞI | 100 ad. | 6.000 | 2,9269 |
| 062 129 008300 | 062 129 108300 | 8x300 KABLO BAĞI | 100 ad. | 5.000 | 3,8868 |
| 062 129 008380 | 062 129 108380 | 8x380 KABLO BAĞI | 100 ad. | 5.000 | 4,1832 |
| 062 129 008450 | 062 129 108450 | 8x450 KABLO BAĞI | 100 ad. | 3.500 | 4,6820 |
| 062 129 008550 | 062 129 108550 | 8x550 KABLO BAĞI | 100 ad. | 3.000 | 6,2725 |
| 062 129 008750 | 062 129 108750 | 8x750 KABLO BAĞI | 100 ad. | 2.000 | 10,0322 |
| 062 129 009762 | 062 129 109762 | 9x762 KABLO BAĞI | 100 ad. | 1.500 | 13,3779 |
| 062 129 009940 | 062 129 109940 | 9x940 KABLO BAĞI | 100 ad. | 1.500 | 15,4625 |

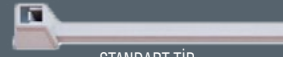

STANDART TİP





| Ürün Kodu | Ürün Adı | Kutu Adet | Koli Adet | Fiyat (₺) | | |
|--|--------------------------------|----------------|-----------|-----------|-------|-------|
| KROŞE VE KLİPSLER | | | | | | |
| 062 129 132020 | 20x20 YAPIŞKANLI KROŞE | 100 ad. | 20.000 | 1,500 | | |
| 062 129 132828 | 28x28 YAPIŞKANLI KROŞE | 100 ad. | 9.000 | 2,529 | | |
| 062 129 131316 | 13x16 YAPIŞKANLI KLİPS | 100 ad. | 7.000 | 1,509 | | |
| 062 129 191325 | 13x25 YAPIŞKANLI KLİPS | 100 ad. | 5.000 | 1,963 | | |
| 062 129 132525 | 25x25 YAPIŞKANLI KLİPS (BEYAZ) | 100 ad. | 3.000 | 3,176 | | |
| 062 129 142525 | 25x25 YAPIŞKANLI KLİPS (SİYAH) | 100 ad. | 2.000 | 3,396 | | |
| 062 129 151017 | 10x17 VİDALI KROŞE | 250 ad. | 12.500 | 1,146 | | |
| 062 129 151530 | 15x30 VİDALI KROŞE | 100 ad. | 5.000 | 1,718 | | |
| 062 129 151723 | 17x23 VİDALI KROŞE | 250 ad. | 5.000 | 1,798 | | |
| 062 129 161004 | DÜBELLİ KROŞE 6 DELİK İÇİN | 500 ad. | 15.000 | 0,856 | | |
| 062 129 171009 | DUVAR KROŞESİ 6 DELİK İÇİN | 250 ad. | 7.500 | 1,494 | | |
| 033 129 100008 | DUVAR KROŞESİ 8 DELİK İÇİN | 250 ad. | 9.000 | 1,774 | | |
| 062 129 171011 | KANAL KROŞESİ 6 DELİK İÇİN | 250 ad. | 7.500 | 1,465 | | |
| 062 129 500003 | KABLO KLİPSİ 6,4 (1/4") | 100 ad. | 10.000 | 0,972 | | |
| 062 129 500004 | KABLO KLİPSİ 7,9 (5/16") | 100 ad. | 5.000 | 1,107 | | |
| 062 129 500005 | KABLO KLİPSİ 10,9 (3/8") | 100 ad. | 5.000 | 1,189 | | |
| KELEPÇELER | | | | | | |
| 062 129 010101 | 2x105 | BONCUK KELEPÇE | 1000 ad. | 25.000 | 0,422 | |
| 062 129 010102 | 3,5x165 | BONCUK KELEPÇE | 500 ad. | 8.000 | 1,024 | |
| 062 129 500000 | 3,5x235 | BONCUK KELEPÇE | 100 ad. | 5.000 | 1,626 | |
| 060 120 005105 | 4,5 mm | BURMA KELEPÇE | 500 ad. | 50.000 | 0,600 | |
| 060 120 007107 | 7,0 mm | BURMA KELEPÇE | 500 ad. | 45.000 | 0,635 | |
| 060 120 010110 | 10,5 mm | BURMA KELEPÇE | 500 ad. | 35.000 | 0,802 | |
| 060 120 014114 | 14 mm | BURMA KELEPÇE | 500 ad. | 30.000 | 0,822 | |
| 060 120 017117 | 17 mm | BURMA KELEPÇE | 500 ad. | 15.000 | 0,959 | |
| ETİKETLER | | | | | | |
| 062 129 111035 | 10X35 KABLO BAĞI ETİKETİ | 100 ad. | 4.000 | 2,519 | | |
| 062 129 112045 | 20X45 KABLO BAĞI ETİKETİ | 100 ad. | 1.500 | 4,998 | | |
| 062 129 121730 | 17X30 YAPIŞKANLI PANO ETİKETİ | 100 ad. | 5.000 | 3,099 | | |
| 062 129 121750 | 17X50 YAPIŞKANLI PANO ETİKETİ | 50 ad. | 2.000 | 4,122 | | |
| 062 129 122075 | 17X75 YAPIŞKANLI PANO ETİKETİ | 25 ad. | 1.500 | 5,623 | | |
| HELEZON PANO SİRALI XX yerine 00 Şeffaf / XX yerine 11 Siyah | | | | | | |
| | | İç Çap | Dış Çap | | | |
| 001 020 500001 05 XX | NO.1 PANO SİRALI (50cm) | 5 | 6 | 100 ad. | 4.000 | 3,67 |
| 001 020 500002 05 XX | NO.2 PANO SİRALI (50cm) | 7 | 8 | 100 ad. | 3.000 | 5,10 |
| 001 020 500003 05 XX | NO.3 PANO SİRALI (50cm) | 10 | 11 | 100 ad. | 2.000 | 5,81 |
| 001 020 500004 05 XX | NO.4 PANO SİRALI (50cm) | 13 | 14 | 50 ad. | 800 | 11,18 |
| 001 020 500005 05 XX | NO.5 PANO SİRALI (50cm) | 16 | 17 | 25 ad. | 800 | 12,55 |
| HELEZON PANO SİRALI (RULO) XX yerine 00 Şeffaf / XX yerine 11 Siyah | | | | | | |
| 001 020 600001 00 XX | NO.1 PANO SİRALI (100cm) | 5 | 6 | 100 mt. | 4.000 | 7,63 |
| 001 020 600002 00 XX | NO.2 PANO SİRALI (100cm) | 7 | 8 | 100 mt. | 3.000 | 9,62 |
| 001 020 600003 00 XX | NO.3 PANO SİRALI (100cm) | 10 | 11 | 100 mt. | 2.000 | 11,61 |
| 001 020 600004 00 XX | NO.4 PANO SİRALI (100cm) | 13 | 14 | 50 mt. | 800 | 22,36 |
| 001 020 600005 00 XX | NO.5 PANO SİRALI (100cm) | 16 | 17 | 50 mt. | 800 | 25,83 |



RAY KLEMENSLER - VİDALI

CE

| Ürün Kodu | Ürün Adı | Kutu Adet | Fiyat (₺) |
|----------------|---------------------------|-----------|-----------|
| 010 094 00XX25 | 2,5 mm RAY KLEMENSİ | 100 | 21,552 |
| 010 094 00XX04 | 4 mm RAY KLEMENSİ | 100 | 23,206 |
| 010 094 00XX06 | 6 mm RAY KLEMENSİ | 100 | 37,129 |
| 010 094 00XX10 | 10 mm RAY KLEMENSİ | 100 | 46,411 |
| 010 094 00XX16 | 16 mm RAY KLEMENSİ | 30 | 77,352 |
| 010 094 00XX35 | 35 mm RAY KLEMENSİ | 20 | 138,461 |
| 010 094 010001 | KLEMENS DURDURUCU ● (GRİ) | 100 | 20,964 |

RENK KODLARI

XX : 00 GRİ XX : 11 SİYAH
 XX : 14 SARI XX : 21 KAHVE
 XX : 13 MAVİ XX : 15 YEŞİL
 XX : 16 KIRMIZI



RAY KLEMENSLER - TOPRAKLAMALI

CE

| Ürün Kodu | Ürün Adı | Kutu Adet | Fiyat (₺) |
|----------------|----------------------------------|-----------|-----------|
| 010 094 010003 | 2,5 mm TOPRAKLAMALI RAY KLEMENSİ | 100 | 84,384 |
| 010 094 010008 | 4 mm TOPRAKLAMALI RAY KLEMENSİ | 100 | 96,691 |
| 010 094 010004 | 6 mm TOPRAKLAMALI RAY KLEMENSİ | 100 | 136,832 |
| 010 094 010009 | 10 mm TOPRAKLAMALI RAY KLEMENSİ | 100 | 142,985 |
| 010 094 010005 | 16 mm TOPRAKLAMALI RAY KLEMENSİ | 30 | 222,681 |
| 010 094 010010 | 35 mm TOPRAKLAMALI RAY KLEMENSİ | 20 | 298,580 |



YAY BASKILI RAY KLEMENSLER

CE

| Ürün Kodu | Ürün Adı | Kutu Adet | Fiyat (₺) |
|----------------|-----------------------------------|-----------|-----------|
| 010 094 010011 | 2,5 mm RAY KLEMENSİ (YAY BASKILI) | 100 | 24,753 |
| 010 094 010012 | 4 mm RAY KLEMENSİ (YAY BASKILI) | 100 | 33,262 |
| 010 094 010013 | 6 mm RAY KLEMENSİ (YAY BASKILI) | 100 | 61,882 |
| 010 094 010014 | 10 mm RAY KLEMENSİ (YAY BASKILI) | 100 | 68,844 |

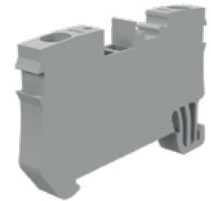

SİGORTALI RAY KLEMENSLER

CE

| Ürün Kodu | Ürün Adı | Kutu Adet | Fiyat (₺) |
|----------------|-----------------------|-----------|-----------|
| 010 094 000051 | SİGORTALI RAY KLEMENS | 75 | 158,572 |



DEKAFİX

| Ürün Kodu | Ürün Adı | Kutu Adet | Fiyat (₺) |
|----------------|---------------------------------|-----------|-----------|
| 010 094 010006 | YAZILI DEKAFİX (1 ADET FİYATI) | 500 | 1,575 |
| 010 094 010007 | YAZISIZ DEKAFİX (1 ADET FİYATI) | 500 | 1,212 |

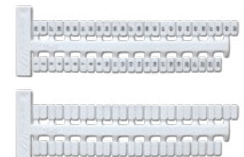

PANO TOPRAKLAMA KLEMENSLERİ (6x8 mm) 63A

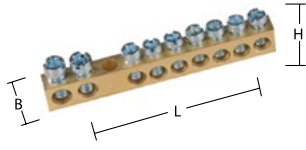

| Ürün Kodu | Ürün Adı | L | B | H | Kutu Adet | Fiyat (₺) |
|----------------|----------------------------------|---|---|----|-----------|-----------|
| 014 102 006304 | 4 DELİK PANO TOPRAKLAMA KLEMENS | 6 | 8 | 33 | 100 | 36,970 |
| 014 102 006305 | 5 DELİK PANO TOPRAKLAMA KLEMENS | 6 | 8 | 38 | 100 | 40,670 |
| 014 102 006306 | 6 DELİK PANO TOPRAKLAMA KLEMENS | 6 | 8 | 45 | 100 | 50,530 |
| 014 102 006307 | 7 DELİK PANO TOPRAKLAMA KLEMENS | 6 | 8 | 50 | 100 | 55,460 |
| 014 102 006309 | 9 DELİK PANO TOPRAKLAMA KLEMENS | 6 | 8 | 62 | 100 | 62,850 |
| 014 102 006310 | 10 DELİK PANO TOPRAKLAMA KLEMENS | 6 | 8 | 68 | 100 | 77,640 |
| 014 102 006312 | 12 DELİK PANO TOPRAKLAMA KLEMENS | 6 | 8 | 80 | 100 | 93,660 |

PANO TOPRAKLAMA KLEMENSLERİ AYAKLI (6,5X9 mm) 80A

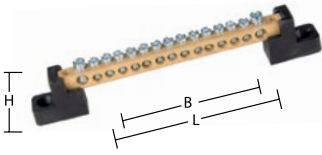

| Ürün Kodu | Ürün Adı | L | B | H | Kutu Adet | Fiyat (₺) |
|----------------|---------------------------------|-----|-----|----|-----------|-----------|
| 014 102 008006 | 6 DELİK AYAKLI DAĞITIM ÜNİTESİ | 85 | 70 | 22 | 200 | 88,73 |
| 014 102 008010 | 10 DELİK AYAKLI DAĞITIM ÜNİTESİ | 108 | 95 | 22 | 150 | 118,31 |
| 014 102 008012 | 12 DELİK AYAKLI DAĞITIM ÜNİTESİ | 120 | 106 | 22 | 150 | 125,71 |
| 014 102 008015 | 15 DELİK AYAKLI DAĞITIM ÜNİTESİ | 138 | 124 | 22 | 125 | 151,59 |
| 014 102 008020 | 20 DELİK AYAKLI DAĞITIM ÜNİTESİ | 165 | 152 | 22 | 100 | 199,65 |

1 KUTUP DAĞITIM ÜNİTESİ 125A

CE

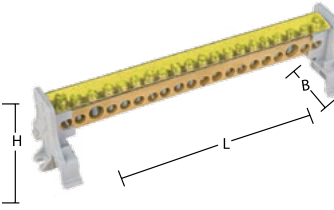

| Ürün Kodu | Ürün Adı | Cinsi | L | B | H | Koli Adet | Fiyat (₺) |
|----------------|--------------------------------|-------|-----|----|----|-----------|-----------|
| 014 102 112507 | 125 A. 1 KUTUP DAĞITIM ÜNİTESİ | 2+5 | 76 | 44 | 42 | 70 | 211,97 |
| 014 102 112510 | 125 A. 1 KUTUP DAĞITIM ÜNİTESİ | 2+8 | 100 | 44 | 42 | 60 | 246,48 |
| 014 102 112512 | 125 A. 1 KUTUP DAĞITIM ÜNİTESİ | 2+10 | 115 | 44 | 42 | 55 | 283,45 |
| 014 102 112515 | 125 A. 1 KUTUP DAĞITIM ÜNİTESİ | 2+13 | 135 | 44 | 42 | 45 | 357,40 |
| 014 102 112520 | 125 A. 1 KUTUP DAĞITIM ÜNİTESİ | 2+18 | 170 | 44 | 42 | 35 | 443,67 |
| 014 102 112522 | 125 A. 1 KUTUP DAĞITIM ÜNİTESİ | 2+20 | 185 | 44 | 42 | 30 | 492,96 |

2 KUTUP DAĞITIM ÜNİTESİ 125A

CE

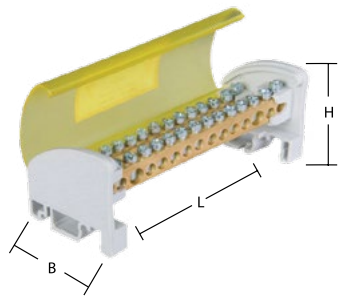

| Ürün Kodu | Ürün Adı | Cinsi | L | B | H | Koli Adet | Fiyat (₺) |
|----------------|--------------------------------|-------|-----|----|----|-----------|-----------|
| 014 102 212507 | 125 A. 2 KUTUP DAĞITIM ÜNİTESİ | 2+5 | 81 | 90 | 50 | 20 | 431,34 |
| 014 102 212510 | 125 A. 2 KUTUP DAĞITIM ÜNİTESİ | 2+8 | 103 | 90 | 50 | 16 | 468,31 |
| 014 102 212512 | 125 A. 2 KUTUP DAĞITIM ÜNİTESİ | 2+10 | 118 | 90 | 50 | 12 | 517,61 |
| 014 102 212515 | 125 A. 2 KUTUP DAĞITIM ÜNİTESİ | 2+13 | 142 | 90 | 50 | 10 | 665,50 |
| 014 102 212520 | 125 A. 2 KUTUP DAĞITIM ÜNİTESİ | 2+18 | 178 | 90 | 50 | 8 | 838,04 |

4 KUTUP DAĞITIM ÜNİTESİ 125A

CE

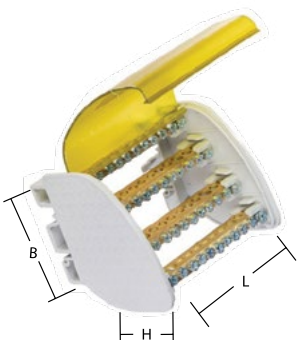

| Ürün Kodu | Ürün Adı | Cinsi | L | B | H | Koli Adet | Fiyat (₺) |
|----------------|--------------------------------|-------|-----|----|----|-----------|-----------|
| 014 102 412507 | 125 A. 4 KUTUP DAĞITIM ÜNİTESİ | 2+5 | 60 | 80 | 75 | 10 | 813,39 |
| 014 102 412510 | 125 A. 4 KUTUP DAĞITIM ÜNİTESİ | 2+8 | 83 | 80 | 75 | 8 | 879,94 |
| 014 102 412512 | 125 A. 4 KUTUP DAĞITIM ÜNİTESİ | 2+10 | 97 | 80 | 75 | 6 | 973,60 |
| 014 102 412515 | 125 A. 4 KUTUP DAĞITIM ÜNİTESİ | 2+13 | 120 | 80 | 75 | 5 | 1.207,76 |
| 014 102 412520 | 125 A. 4 KUTUP DAĞITIM ÜNİTESİ | 2+18 | 155 | 80 | 75 | 4 | 1.572,55 |
| 014 102 412522 | 125 A. 4 KUTUP DAĞITIM ÜNİTESİ | 2+20 | 170 | 80 | 75 | 4 | 1.676,07 |
| 014 102 412525 | 125 A. 4 KUTUP DAĞITIM ÜNİTESİ | 2+23 | 191 | 80 | 75 | 4 | 1.934,88 |

swiss SERİSİ

GEÇMELİ ve TIRNAK TİP BUAT KLEMENSLER



| Ürün Kodu | Ürün Adı | Kutu Adet | Koli Adet | Fiyat |
|---|---|-----------|-----------|----------|
| SWISS GEÇMELİ BUAT KLEMENS | | | | |
| 999 094 225000 | 2'Lİ GEÇMELİ BUAT KLEMENS (0,5-2,5 mm ²) | 100 | 5000 | 0,149 \$ |
| 999 094 325000 | 3'LÜ GEÇMELİ BUAT KLEMENS (0,5-2,5 mm ²) | 100 | 5000 | 0,264 \$ |
| 999 094 425000 | 4'LÜ GEÇMELİ BUAT KLEMENS (0,5-2,5 mm ²) | 100 | 5000 | 0,304 \$ |
| 999 094 525000 | 5'Lİ GEÇMELİ BUAT KLEMENS (0,5-2,5 mm ²) | 100 | 5000 | 0,329 \$ |
| 999 094 625000 | 6-Lİ GEÇMELİ BUAT KLEMENS (0,5-2,5 mm ²) | 50 | 2500 | 0,345 \$ |
| 999 094 825000 | 8-Lİ GEÇMELİ BUAT KLEMENS (0,5-2,5 mm ²) | 50 | 2500 | 0,417 \$ |
| SWISS TIRNAKLI BUAT KLEMENS | | | | |
| 999 094 241000 | 2'Lİ TIRNAKLI BUAT KLEMENS (0,5-2,5 mm ²) | 100 | 5000 | 0,464 \$ |
| 999 094 341000 | 3'LÜ TIRNAKLI BUAT KLEMENS (0,5-2,5 mm ²) | 100 | 5000 | 0,606 \$ |
| 999 094 441000 | 4-LÜ TIRNAKLI BUAT KLEMENS (0,5-2,5 mm ²) | 50 | 2500 | 0,627 \$ |
| 999 094 541000 | 5'Lİ TIRNAKLI BUAT KLEMENS (0,5-2,5 mm ²) | 50 | 2500 | 0,959 \$ |
| BUAT KLEMENS | | | | |
| 015 094 160001 | NO. 2 ZEYTİN (BUAT) KLEMENS | 1000 | 12000 | 2,34 |
| ŞEFFAF ISIYA DAYANIKLI BUAT KLEMENSLER | | | | |
| 888 094 000105 | NO.2 ŞEFFAF BUAT KLEMENS (1 ADET FİYAT) | | 560 | 6,42 |
| 888 094 000205 | NO.3 ŞEFFAF BUAT KLEMENS (1 ADET FİYAT) | | 360 | 9,08 |
| 888 094 000405 | NO.4 ŞEFFAF BUAT KLEMENS (1 ADET FİYAT) | | 200 | 14,94 |
| 888 094 000605 | NO.5 ŞEFFAF BUAT KLEMENS (1 ADET FİYAT) | | 120 | 20,22 |
| GEÇMELİ SOKET KLEMENSLER | | | | |
| 999 999 991212 | 12'Lİ GEÇMELİ SOKET KLEMENS | 25 | 500 | 186,94 |
| PLASTİK SIRA KLEMENSLER | | | | |
| 015 094 150001 | NO. 1 SIRA KLEMENSLER (2,5-4 mm ²) | 50 | 600 | 50,83 |
| 015 094 150002 | NO. 2 SIRA KLEMENSLER (4-6 mm ²) | 50 | 600 | 66,30 |
| 015 094 150003 | NO. 3 SIRA KLEMENSLER (6-10 mm ²) | 50 | 400 | 83,63 |
| 015 094 150004 | NO. 4 SIRA KLEMENSLER (10-16 mm ²) | 50 | 400 | 91,13 |
| 015 094 150005 | NO. 5 SIRA KLEMENSLER (16-25 mm ²) | 50 | 400 | 99,79 |
| ISIYA DAYANIKLI SIRA KLEMENSLER | | | | |
| 015 094 170001 | NO. 1 ISIYA DAYANIKLI KLEMENSLER (2,5-4 mm ²) | 50 | 600 | 54,11 |
| 015 094 170002 | NO. 2 ISIYA DAYANIKLI KLEMENSLER (4-6 mm ²) | 50 | 600 | 70,51 |
| 015 094 170003 | NO. 3 ISIYA DAYANIKLI KLEMENSLER (6-10 mm ²) | 50 | 400 | 89,25 |
| 015 094 170004 | NO. 4 ISIYA DAYANIKLI KLEMENSLER (10-16 mm ²) | 50 | 400 | 96,75 |
| 015 094 170005 | NO. 5 ISIYA DAYANIKLI KLEMENSLER (16-25 mm ²) | 50 | 400 | 106,12 |
| PORSELEN KLEMENSLER | | | | |
| 015 094 180002 | NO. 1-2'Lİ PORSELEN KLEMENS (2,5-4 mm ²) | 396 | | 17,97 |
| 015 094 180003 | NO. 1-3'LÜ PORSELEN KLEMENS (2,5-4 mm ²) | 264 | | 21,82 |
| 015 094 180004 | NO. 2-2'Lİ PORSELEN KLEMENS (4-6 mm ²) | 250 | | 21,82 |
| 015 094 180005 | NO. 2-3'LÜ PORSELEN KLEMENS (4-6 mm ²) | 150 | | 31,23 |
| 015 094 180006 | NO. 3-2'Lİ PORSELEN KLEMENS (6-10 mm ²) | 128 | | 31,23 |
| 015 094 180007 | NO. 3-3'LÜ PORSELEN KLEMENS (6-10 mm ²) | 84 | | 39,36 |
| U KLEMENSLER | | | | |
| 014 094 030006 | 6'LİK U KLEMENS | 300 | | 32,94 |
| 014 094 030010 | 10'LÜK U KLEMENS | 250 | | 42,35 |
| 014 094 030016 | 16'LİK U KLEMENS | 100 | | 56,47 |
| 014 094 030025 | 25'LİK U KLEMENS | 100 | | 68,23 |
| 014 094 030035 | 35'LİK U KLEMENS | 75 | | 72,94 |
| 014 094 030050 | 50'LİK U KLEMENS | 50 | | 115,29 |
| 014 094 030070 | 70'LİK U KLEMENS | 40 | | 158,98 |
| 014 094 030095 | 95'LİK U KLEMENS | 25 | | 197,53 |
| 014 094 030120 | 120'LİK U KLEMENS | 20 | | 252,36 |
| 014 094 030150 | 150'LİK U KLEMENS | 15 | | 347,51 |

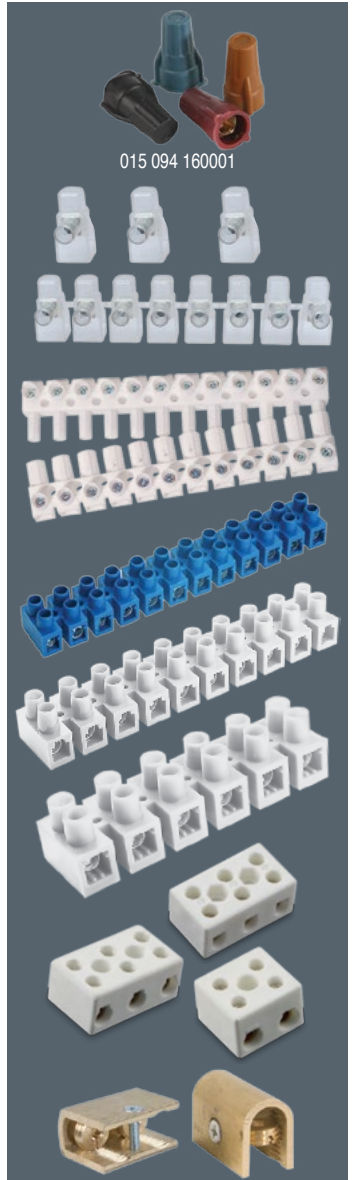

İZOLELİ KABLO YÜKSÜKLERİ - TEK GİRİŞ FRANSIZ - ALMAN NORMLARI



Standart : DIN 46228
Malzeme : Bakır
İzolasyon : Nylon
Voltaj : <600V
Çalışma Sıcaklığı : Max. 105°

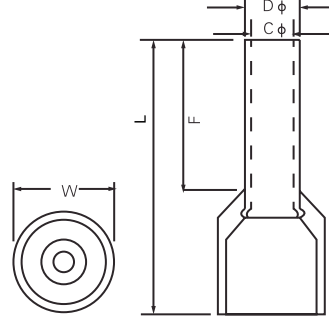

X= 0 Fransız X= F Fransız
X= 2 Alman X=A Alman

| Ürün Kodu | Model Kodu | Ebatlar | | | | | Kablo Kesiti | Renk | | Kutu Adet | Fiyat (Adet/₺) |
|----------------|------------|---------|------|------|------|------|--------------|------------|------------|-----------|----------------|
| | | F | L | W | DØ | CØ | | Fransız | Alman | | |
| 014 100 X10258 | ITYX-0258 | 8.0 | 12.5 | 2.5 | 1.0 | 0.7 | 0.25 | Menekşe | Mavi | 1.000 | 0,97 |
| 014 100 X10348 | ITYX-0348 | 8.0 | 12.5 | 2.5 | 1.1 | 0.8 | 0.34 | Pembe | Turkuaz | 1.000 | 0,97 |
| 014 100 X10508 | ITYX-0508 | 8.0 | 14.0 | 2.6 | 1.3 | 1.0 | 0.50 | Beyaz | Turuncu | 1.000 | 0,43 |
| 014 100 X17508 | ITYX-7508 | 8.0 | 14.6 | 2.8 | 1.6 | 1.3 | 0.75 | Mavi | Beyaz | 1.000 | 0,43 |
| 014 100 X11008 | ITYX-1008 | 8.0 | 14.6 | 3.0 | 1.8 | 1.5 | 1.0 | Kırmızı | Sarı | 1.000 | 0,43 |
| 014 100 X11508 | ITYX-1508 | 8.0 | 16.4 | 3.5 | 2.1 | 1.8 | 1.5 | Siyah | Kırmızı | 1.000 | 0,48 |
| 014 100 X12508 | ITYX-2508 | 8.0 | 15.2 | 4.0 | 2.6 | 2.3 | 2.5 | Gri | Mavi | 500 | 0,61 |
| 014 100 X14009 | ITYX-4009 | 9.0 | 16.5 | 4.4 | 3.2 | 2.8 | 4.0 | Turuncu | Gri | 500 | 1,03 |
| 014 100 X16012 | ITYX-6012 | 12.0 | 20.0 | 6.3 | 3.9 | 3.5 | 6.0 | Yeşil | Siyah | 250 | 1,39 |
| 014 100 X11012 | ITYX-1012 | 12.0 | 21.5 | 7.6 | 4.9 | 4.5 | 10.0 | Kahverengi | Bej | 100 | 1,77 |
| 014 100 X11612 | ITYX-1612 | 12.0 | 22.2 | 8.8 | 6.2 | 5.8 | 16.0 | Bej | Yeşil | 100 | 2,46 |
| 014 100 X12516 | ITYX-2516 | 16.0 | 29.0 | 11.2 | 7.9 | 7.5 | 25.0 | Siyah | Kahverengi | 50 | 4,12 |
| 014 100 X13516 | ITYX-3516 | 16.0 | 30.0 | 12.7 | 8.7 | 8.3 | 35.0 | Kırmızı | Bej | 25 | 5,12 |
| 014 100 X15020 | ITYX-5020 | 20.0 | 36.0 | 15.3 | 10.9 | 10.3 | 50.0 | Mavi | Yeşil | 25 | 9,70 |
| 014 100 017020 | ITYF-7020 | 20.0 | 37.0 | 16.0 | 14.3 | 13.5 | 70.0 | Sarı | - | 25 | 17,97 |



İZOLELİ KABLO YÜKSÜKLERİ - ÇİFT GİRİŞ FRANSIZ - ALMAN NORMLARI

Standart : DIN 46228
Malzeme : Bakır
İzolasyon : Nylon
Voltaj : <600V
Çalışma Sıcaklığı : Max. 105°

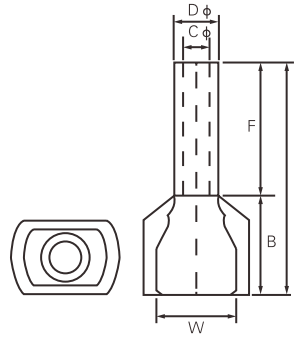

X= 0 Fransız X= F Fransız
X= 2 Alman X=A Alman

| Ürün Kodu | Model Kodu | Ebatlar | | | | | | Kablo Kesiti | Renk | | Kutu Adet | Fiyat (Adet/₺) |
|----------------|------------|---------|------|------|------|-----|-----|--------------|------------|---------|-----------|----------------|
| | | F | L | W | B | DØ | CØ | | Fransız | Alman | | |
| 014 100 X20508 | ICYX-0508 | 8.0 | 14.5 | 5.0 | 6.5 | 1.8 | 1.5 | 2x0.5 | Beyaz | Turuncu | 1.000 | 0,78 |
| 014 100 X27508 | ICYX-7508 | 8.0 | 14.7 | 5.5 | 6.7 | 2.1 | 1.8 | 2x0.75 | Mavi | Beyaz | 500 | 0,82 |
| 014 100 X21008 | ICYX-1008 | 8.0 | 15.1 | 5.5 | 7.1 | 2.3 | 2.0 | 2x1.0 | Kırmızı | Sarı | 500 | 0,88 |
| 014 100 X21508 | ICYX-1508 | 8.0 | 15.5 | 6.4 | 7.2 | 2.6 | 2.3 | 2x1.5 | Siyah | Kırmızı | 500 | 1,06 |
| 014 100 X22510 | ICYX-2510 | 10.0 | 18.5 | 8.0 | 8.5 | 3.3 | 2.9 | 2x2.5 | Gri | Mavi | 250 | 1,71 |
| 014 100 X24012 | ICYX-4012 | 12.0 | 23.1 | 8.8 | 11.1 | 4.2 | 3.8 | 2x4.0 | Turuncu | Gri | 200 | 1,98 |
| 014 100 X26014 | ICYX-6014 | 14.0 | 26.1 | 9.5 | 12.1 | 5.3 | 4.9 | 2x6.0 | Yeşil | Siyah | 100 | 2,46 |
| 014 100 X21014 | ICYX-1014 | 14.0 | 26.6 | 12.6 | 12.0 | 6.9 | 6.5 | 2x10.0 | Kahverengi | Bej | 50 | 3,77 |
| 014 100 X21614 | ICYX-1614 | 14.0 | 31.3 | 19.0 | 17.3 | 8.7 | 8.3 | 2x16.0 | Bej | Yeşil | 50 | 4,79 |

İZOLESİZ KABLO YÜKSÜKLERİ - TEK GİRİŞ



Standart : DIN 46228
Malzeme : Bakır
Voltaj : <600V
Çalışma Sıcaklığı : Max. 105°

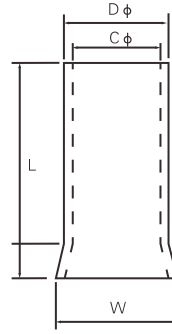

| Ürün Kodu | Model Kodu | Ebatlar | | | | Kablo Kesiti | Kutu Adet | Fiyat (Adet/₺) |
|----------------|------------|---------|------|------|------|--------------|-----------|----------------|
| | | L | W | DØ | CØ | | | |
| 014 100 120510 | KTY-0508 | 10.0 | 1.7 | 1.3 | 1.0 | 0.50 | 2.000 | 0,45 |
| 014 100 127510 | KTY-7508 | 10.0 | 1.9 | 1.6 | 1.3 | 0.75 | 1.000 | 0,47 |
| 014 100 121010 | KTY-1008 | 10.0 | 2.2 | 1.8 | 1.5 | 1.0 | 1.000 | 0,47 |
| 014 100 121510 | KTY-1508 | 10.0 | 2.5 | 2.1 | 1.8 | 1.5 | 1.000 | 0,52 |
| 014 100 122512 | KTY-2508 | 12.0 | 3.3 | 2.6 | 2.3 | 2.5 | 1.000 | 0,70 |
| 014 100 124012 | KTY-4009 | 12.0 | 3.9 | 3.2 | 2.8 | 4.0 | 1.000 | 0,95 |
| 014 100 126012 | KTY-6012 | 12.0 | 4.8 | 3.9 | 3.5 | 6.0 | 500 | 1,30 |
| 014 100 121015 | KTY-1012 | 15.0 | 5.8 | 4.9 | 4.5 | 10.0 | 250 | 2,16 |
| 014 100 121615 | KTY-1612 | 15.0 | 7.2 | 6.2 | 5.8 | 16.0 | 250 | 2,72 |
| 014 100 122516 | KTY-2516 | 16.0 | 9.1 | 7.9 | 7.5 | 25.0 | 100 | 4,14 |
| 014 100 123516 | KTY-3516 | 16.0 | 10.2 | 8.7 | 8.3 | 35.0 | 100 | 4,70 |
| 014 100 125020 | KTY-5020 | 20.0 | 12.4 | 10.9 | 10.3 | 50.0 | 50 | 9,77 |



İZOLELİ YUVARLAK TİP PAPUÇ

Standart : DIN 46228
Malzeme : Bakır
İzolasyon : PVC
Voltaj : <600V
Çalışma Sıcaklığı : Max. 105°

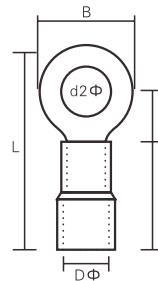

| Ürün Kodu | Model Kodu | Civata Çapı (d2) mm | Ebatlar | | | | | Renk | Kablo Kesiti | Kutu Adet | Fiyat (Adet/₺) |
|----------------|------------|---------------------|---------|------|------|------|-----|---------|---------------------------------|-----------|----------------|
| | | | B | F | L | E | DØ | | | | |
| 014 100 030153 | IYP-1,5-3 | 3.2 | 5.7 | 4.95 | 17.8 | 10.0 | 4.3 | Kırmızı | 0.5 ~1.5 mm ² 19A | 200 | 1,41 |
| 014 100 030154 | IYP-1,5-4 | 4.3 | 8.0 | 7.0 | 21.0 | 10.0 | 4.3 | | | 200 | 2,10 |
| 014 100 030155 | IYP-1,5-5 | 5.3 | 9.5 | 8.5 | 22.2 | 10.0 | 4.3 | | | 200 | 2,13 |
| 014 100 030156 | IYP-1,5-6 | 6.5 | 11.6 | 11.1 | 27.0 | 10.0 | 4.3 | | | 200 | 3,37 |
| 014 100 030158 | IYP-1,5-8 | 8.5 | 11.6 | 11.1 | 27.0 | 10.0 | 4.3 | | | 200 | 3,37 |
| 014 100 030253 | IYP-2,5-3 | 3.2 | 6.6 | 4.8 | 17.8 | 10.0 | 4.9 | Mavi | 1.5 ~2.5 mm ² 27A | 200 | 2,61 |
| 014 100 030254 | IYP-2,5-4 | 4.3 | 8.5 | 7.4 | 21.7 | 10.0 | 4.9 | | | 200 | 2,61 |
| 014 100 030255 | IYP-2,5-5 | 5.3 | 9.5 | 7.4 | 22.5 | 10.0 | 4.9 | | | 200 | 2,64 |
| 014 100 030256 | IYP-2,5-6 | 6.5 | 12.0 | 11.0 | 27.0 | 10.0 | 4.9 | | | 200 | 3,74 |
| 014 100 030258 | IYP-2,5-8 | 8.5 | 12.0 | 11.0 | 27.0 | 10.0 | 4.9 | | | 200 | 3,74 |
| 014 100 032510 | IYP-2,5-10 | 10.5 | 13.6 | 13.9 | 30.7 | 10.0 | 4.9 | 200 | 3,89 | | |
| 014 100 036004 | IYP-6-4 | 4.3 | 9.5 | 8.3 | 26.0 | 13.0 | 6.7 | Sarı | 4 ~6 mm ² 48A | 100 | 5,54 |
| 014 100 036005 | IYP-6-5 | 5.3 | 9.5 | 8.3 | 26.0 | 13.0 | 6.7 | | | 100 | 5,54 |
| 014 100 036006 | IYP-6-6 | 6.5 | 12.0 | 10.5 | 29.5 | 13.0 | 6.7 | | | 100 | 6,29 |
| 014 100 036008 | IYP-6-8 | 8.5 | 15.0 | 13.7 | 35.0 | 13.0 | 6.7 | | | 100 | 8,09 |
| 014 100 036010 | IYP-6-10 | 10.5 | 15.0 | 13.7 | 35.0 | 13.0 | 6.7 | | | 100 | 8,16 |
| 014 100 036012 | IYP-6-12 | 13.0 | 19.2 | 16.0 | 39.4 | 13.0 | 6.7 | | | 100 | 8,31 |

ÇATAL TİP İZOLELİ KABLO UÇLARI



Standart : DIN 46228
Malzeme : Bakır
İzolasyon : PVC
Voltaj : <600V
Çalışma Sıcaklığı : Max. 105°

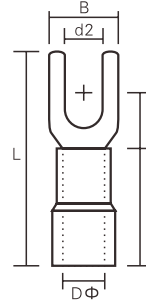

| Ürün Kodu | Model Kodu | Civata Çapı (d2) mm | Ebatlar | | | | | Renk | Kablo Kesiti | Kutu Adet | Fiyat (Adet/₺) |
|----------------|------------|---------------------|---------|------|------|------|-----|---------|---------------------------------|-----------|----------------|
| | | | B | F | L | H | DØ | | | | |
| 014 100 040153 | ICP-1,5-3 | 3.2 | 5.7 | 6.5 | 21.2 | 10.0 | 4.3 | Kırmızı | 0.5 ~1.5 mm ² 19A | 200 | 1,92 |
| 014 100 040154 | ICP-1,5-4 | 4.3 | 8.1 | 6.5 | 21.2 | 10.0 | 4.3 | | | 200 | 1,98 |
| 014 100 040155 | ICP-1,5-5 | 5.3 | 9.5 | 6.5 | 21.2 | 10.0 | 4.3 | | | 200 | 2,07 |
| 014 100 040156 | ICP-1,5-6 | 6.5 | 12.0 | 11.0 | 27.2 | 10.0 | 4.3 | | | 200 | 2,34 |
| 014 100 040253 | ICP-2,5-3 | 3.2 | 5.7 | 6.5 | 21.2 | 10.0 | 4.9 | Mavi | 1.5 ~2.5 mm ² 27A | 200 | 2,16 |
| 014 100 040254 | ICP-2,5-4 | 4.3 | 8.1 | 6.5 | 21.2 | 10.0 | 4.9 | | | 200 | 2,22 |
| 014 100 040255 | ICP-2,5-5 | 5.3 | 9.5 | 6.5 | 21.2 | 10.0 | 4.9 | | | 200 | 2,25 |
| 014 100 040256 | ICP-2,5-6 | 6.5 | 12.0 | 11.0 | 27.2 | 10.0 | 4.9 | | | 200 | 2,99 |
| 014 100 046004 | ICP-6-4 | 4.3 | 9.0 | 7.5 | 26.5 | 13.0 | 6.7 | Sarı | 4 ~6 mm ² 48A | 100 | 4,87 |
| 014 100 046005 | ICP-6-5 | 5.3 | 9.0 | 7.5 | 26.5 | 13.0 | 6.7 | | | 100 | 4,94 |
| 014 100 046006 | ICP-6-6 | 6.5 | 12.0 | 12.0 | 32.5 | 13.0 | 6.7 | | | 100 | 6,59 |
| 014 100 046008 | ICP-6-8 | 8.5 | 14.0 | 11.5 | 31.5 | 13.0 | 6.7 | | | 100 | 7,71 |

TAM İZOLELİ FASTON DİŞİ TERMİNAL



Malzeme : Pirinç
İzolasyon : PVC
Voltaj : <600V
Çalışma Sıcaklığı : Max. 75°

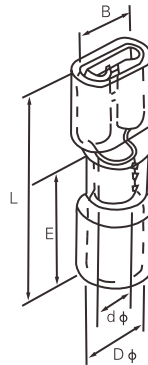

| Ürün Kodu | Model Kodu | Soket Ölçüsü | Kalınlık (mm) | Ebatlar | | | | | Renk | Kablo Kesiti | Kutu Adet | Fiyat (Adet/₺) |
|----------------|-----------------|--------------|---------------|---------|-----|-----|------|------|---------|---------------------------------|-----------|----------------|
| | | | | B | DØ | dØ | L | E | | | | |
| 014 100 090508 | TDT-0,5-1/2.8 | 0.5x2.8 | 0.30 | 3.3 | 3.8 | 1.7 | 20.0 | 10.0 | Kırmızı | 0.5 ~1.5 mm ² 10A | 200 | 2,16 |
| 014 100 090509 | TDT-0,5-1/4.8 | 0.8x4.75 | 0.35 | 5.0 | 3.8 | 1.7 | 20.5 | 10.0 | | | 200 | 2,55 |
| 014 100 090510 | TDT-0,5-1/6.4 | 0.8x6.35 | 0.40 | 6.6 | 3.8 | 1.7 | 22.4 | 10.0 | | | 200 | 3,03 |
| 014 100 091523 | TDT-1,5-2,5/2.8 | 0.8x2.8 | 0.30 | 3.3 | 4.3 | 2.3 | 20.0 | 10.0 | Mavi | 1.5 ~2.5 mm ² 15A | 200 | 2,55 |
| 014 100 091524 | TDT-1,5-2,5/4.8 | 0.8x4.75 | 0.35 | 5.0 | 4.3 | 2.3 | 20.5 | 10.0 | | | 200 | 2,62 |
| 014 100 091525 | TDT-1,5-2,5/6.4 | 0.8x6.35 | 0.40 | 6.6 | 4.3 | 2.3 | 22.7 | 10.0 | | | 200 | 3,18 |
| 014 100 094060 | TDT-4-6 | 0.8x6.35 | 0.40 | 6.6 | 5.7 | 3.4 | 23.0 | 12.5 | Sarı | 4 ~6 mm ² 24A | 100 | 3,66 |

TAM İZOLELİ DİŞİ TERMİNAL



Malzeme : Pirinç
İzolasyon : PVC
Voltaj : <600V
Çalışma Sıcaklığı : Max.75°

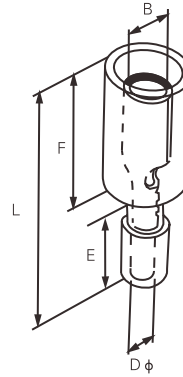

| Ürün Kodu | Model Kodu | Kalınlık mm | Ebatlar | | | | | Renk | Kablo Kesiti | Kutu Adet | Fiyat (Adet/₺) |
|----------------|-------------|-------------|---------|-----|-----|------|------|---------|---------------------------------|-----------|----------------|
| | | | B | F | DØ | E | L | | | | |
| 014 100 100510 | YDT-0,5-1 | 0.40 | 4.0 | 7.0 | 1.7 | 10.5 | 23.3 | Kırmızı | 0.5 ~1.5 mm ² 10A | 200 | 5,99 |
| 014 100 101525 | YDT-1,5-2,5 | 0.40 | 5.0 | 7.0 | 2.3 | 10.5 | 25.1 | Mavi | 1.5 ~2.5 mm ² 15A | 100 | 6,74 |
| 014 100 104060 | YDT-4-6 | 0.40 | 5.0 | 7.0 | 3.4 | 12.5 | 25.1 | Sarı | 4 ~6 mm ² 24A | 100 | 8,38 |

İZOLELİ EK MUF - UZUN TİP



Standart : DIN 46237
Malzeme : Bakır / Copper
İzolasyon : PVC
Voltaj : <600V
Çalışma Sıcaklığı : Max. 75°

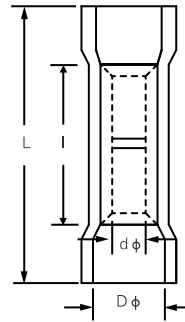

| Ürün Kodu | Model Kodu | Maximum Akım | Ebatlar | | | | Renk | Kablo Kesiti | Kutu Adet | Fiyat (Adet/₺) |
|----------------|------------|--------------|---------|-----|-----|------|---------|--------------------------|-----------|----------------|
| | | | I | dØ | DØ | L | | | | |
| 014 100 070015 | IEM-1,5 | 19A | 15.0 | 1.7 | 4.3 | 25.0 | Kırmızı | 0.5 ~1.5 mm ² | 200 | 2,99 |
| 014 100 070025 | IEM-2,5 | 27A | 15.0 | 2.3 | 4.9 | 25.0 | Mavi | 1.5 ~2.5 mm ² | 200 | 2,99 |
| 014 100 070040 | IEM-4 | 48A | 15.0 | 3.4 | 6.7 | 25.0 | Sarı | 4 ~6 mm ² | 100 | 5,09 |

İZOLELİ FASTON ERKEK TERMİNAL



Malzeme : Pirinç
İzolasyon : PVC
Voltaj : <600V
Çalışma Sıcaklığı : Max. 75°

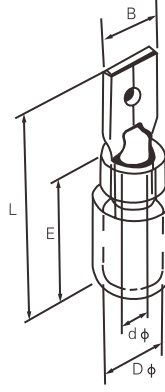

| Ürün Kodu | Model Kodu | Soket Ölçüsü | Kalınlık (mm) | Ebatlar | | | | | Renk | Kablo Kesiti | Kutu Adet | Fiyat (Adet/₺) |
|----------------|-------------|--------------|---------------|---------|-----|-----|------|------|---------|---------------------------------|-----------|----------------|
| | | | | B | DØ | dØ | L | E | | | | |
| 014 100 060013 | IFE-1,5/2.8 | 0.8x2.8 | 0.8 | 2.8 | 1.7 | 3.8 | 17.7 | 10.0 | Kırmızı | 0.5 ~1.5 mm ² 10A | 200 | 1,42 |
| 014 100 060014 | IFE-1,5/4.8 | 0.4x4.75 | 0.4x2 | 4.8 | 1.7 | 3.8 | 20.0 | 10.0 | | | 200 | 1,62 |
| 014 100 060015 | IFE-1,5/6.4 | 0.8x6.35 | 0.4x2 | 6.4 | 1.7 | 3.8 | 21.0 | 10.0 | | | 200 | 2,10 |
| 014 100 060023 | IFE-2,5/2.8 | 0.8x2.8 | 0.8 | 2.8 | 2.3 | 4.3 | 17.7 | 10.0 | Mavi | 1.5 ~2.5 mm ² 15A | 200 | 1,42 |
| 014 100 060024 | IFE-2,5/4.8 | 0.4x4.75 | 0.4x2 | 4.8 | 2.3 | 4.3 | 20.0 | 10.0 | | | 200 | 1,80 |
| 014 100 060025 | IFE-2,5/6.4 | 0.8x6.35 | 0.4x2 | 6.4 | 2.3 | 4.3 | 21.0 | 10.0 | | | 200 | 2,20 |
| 014 100 060040 | IFE-4 | 0.8x6.35 | 0.4x2 | 6.4 | 3.4 | 5.7 | 23.0 | 12.5 | Sarı | 4 ~6 mm ² 24A | 200 | 2,58 |

YUVARLAK ERKEK TERMİNAL



Malzeme : Pirinç
İzolasyon : PVC
Voltaj : <600V
Çalışma Sıcaklığı : Max. 75°

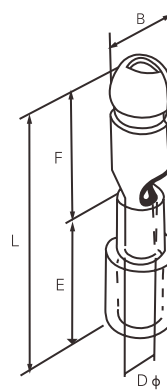

| Ürün Kodu | Model Kodu | Kalınlık mm | Ebatlar | | | | | Renk | Kablo Kesiti | Kutu Adet | Fiyat (Adet/₺) |
|----------------|-------------|-------------|---------|-----|-----|------|------|---------|---------------------------------|-----------|----------------|
| | | | B | F | DØ | E | L | | | | |
| 014 100 110510 | YET-0,5-1 | 0.4 | 4.0 | 8.5 | 1.7 | 10.5 | 21.5 | Kırmızı | 0.5 ~1.5 mm ² 10A | 200 | 4,94 |
| 014 100 111525 | YET-1,5-2,5 | 0.4 | 5.0 | 8.5 | 2.3 | 10.5 | 21.7 | Mavi | 1.5 ~2.5 mm ² 15A | 200 | 5,69 |
| 014 100 114060 | YET-4-6 | 0.4 | 5.0 | 8.5 | 3.4 | 13.0 | 24.0 | Sarı | 4 ~6 mm ² 24A | 200 | 7,64 |

İZOLELİ İĞNE TİP TERMİNAL



Malzeme : Bakır
 İzolasyon : PVC
 Voltaj : <600V
 Çalışma Sıcaklığı : Max. 75°

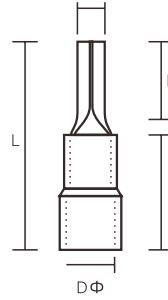

| Ürün Kodu | Model Kodu | Kalınlık mm | Ebatlar | | | | | Renk | Kablo Kesiti | Kutu Adet | Fiyat (Adet/₺) |
|----------------|------------|-------------|---------|------|------|------|-----|---------|---------------------------------|-----------|----------------|
| | | | B | F | L | E | DΦ | | | | |
| 014 100 050015 | IIT-1,5 | 0.7 | 1.9 | 10.0 | 20.0 | 10.0 | 4.3 | Kırmızı | 0.5 ~1.5 mm ² 19A | 200 | 2,25 |
| 014 100 050025 | IIT-2,5 | 0.8 | 1.9 | 12.0 | 22.0 | 10.0 | 4.9 | Mavi | 1.5 ~2.5 mm ² 27A | 200 | 2,70 |
| 014 100 050040 | IIT-4 | 1.0 | 2.8 | 13.0 | 26.8 | 13.0 | 6.7 | Sarı | 4 ~6 mm ² 48A | 100 | 6,44 |

İZOLELİ TAM DIŞI TERMİNAL



Malzeme : Bakır
 İzolasyon : PVC
 Voltaj : <600V
 Çalışma Sıcaklığı : Max. 75°

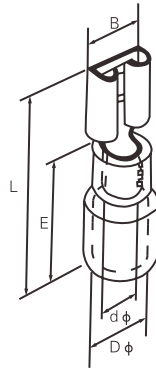

| Ürün Kodu | Model Kodu | Soket Ölçüsü | Kalınlık (mm) | Ebatlar | | | | | Renk | Kablo Kesiti | Kutu Adet | Fiyat (Adet/₺) |
|----------------|-----------------|--------------|---------------|---------|-----|-----|------|------|---------|---------------------------------|-----------|----------------|
| | | | | B | DΦ | dΦ | L | E | | | | |
| 014 100 080508 | IDT-0,5-1/2.8 | 0.8x2.8 | 0.3 | 3.3 | 3.8 | 1.7 | 18.5 | 10.0 | Kırmızı | 0.5 ~1.5 mm ² 10A | 200 | 1,33 |
| 014 100 080509 | IDT-0,5-1/4.8 | 0.8x4.75 | 0.35 | 5.0 | 3.8 | 1.7 | 19.0 | 10.0 | | | 200 | 1,72 |
| 014 100 080510 | IDT-0,5-1/6.4 | 0.8x6.35 | 0.4 | 6.6 | 3.8 | 1.7 | 19.8 | 10.0 | | | 200 | 2,22 |
| 014 100 081523 | IDT-1,5-2,5/2.8 | 0.8x2.8 | 0.3 | 3.3 | 4.3 | 2.3 | 18.5 | 10.0 | Mavi | 1.5 ~2.5 mm ² 15A | 200 | 1,72 |
| 014 100 081524 | IDT-1,5-2,5/4.8 | 0.8x4.75 | 0.35 | 5.0 | 4.3 | 2.3 | 19.0 | 10.0 | | | 200 | 1,80 |
| 014 100 081525 | IDT-1,5-2,5/6.4 | 0.8x6.35 | 0.4 | 6.6 | 4.3 | 2.3 | 19.0 | 10.0 | | | 200 | 2,27 |
| 014 100 084060 | IDT-4-6 | 0.8x6.35 | 0.4 | 6.6 | 5.7 | 3.4 | 23.4 | 12.5 | Sarı | 4 ~6 mm ² 24A | 100 | 2,59 |

İZOLELİ ERKEK - DIŞI TERMİNAL



Malzeme : Pirinç
İzolasyon : PVC
Voltaj : <600V
Çalışma Sıcaklığı : Max. 75°

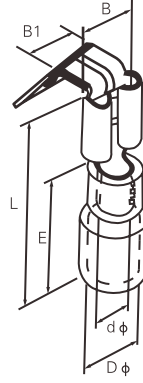

| Ürün Kodu | Model Kodu | Soket Ölçüsü | Ebatlar | | | | | | Renk | Kablo Kesiti | Kutu Adet | Fiyat (Adet/₺) |
|----------------|--------------|--------------|---------|------|------|-----|-----|------|---------|---------------------------------|-----------|----------------|
| | | | B | B1 | E | DØ | dØ | L | | | | |
| 014 100 130515 | IEDT-0,5-1,5 | 0.8x6.35 | 6.6 | 6.35 | 10.0 | 3.8 | 1.7 | 22.5 | Kırmızı | 0.5 ~1.5 mm ² 10A | 100 | 4,19 |
| 014 100 131525 | IEDT-1,5-2,5 | 0.8x6.35 | 6.6 | 6.35 | 10.0 | 4.3 | 2.3 | 22.5 | Mavi | 1.5 ~2.5 mm ² 15A | 100 | 4,34 |
| 014 100 134060 | IEDT-4-6 | 0.8x6.35 | 6.6 | 6.35 | 13.0 | 5.7 | 3.4 | 24.0 | Sarı | 4 ~6 mm ² 24A | 100 | 4,94 |

TAM İZOLELİ FASTON EĞİK DIŞI TERMİNAL



Malzeme : Pirinç
İzolasyon : Nylon
Voltaj : <600V
Sıcaklık : 105° 400V

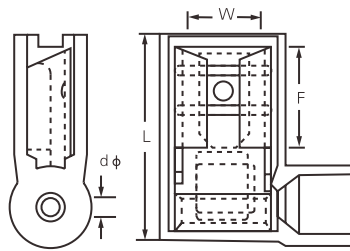

| Ürün Kodu | Model Kodu | Soket Ölçüsü | Ebatlar | | | | Renk | Kablo Kesiti | Kutu Adet | Fiyat (Adet/₺) |
|----------------|--------------|--------------|---------|-----|------|-----|---------|---------------------------------|-----------|----------------|
| | | | W | F | L | dØ | | | | |
| 014 100 140515 | TEDT-0,5-1,5 | 0.8x4.75 | 6.6 | 7.6 | 16.0 | 1.7 | Kırmızı | 0.5 ~1.5 mm ² 10A | 100 | 5,54 |
| 014 100 141525 | TEDT-1,5-2,5 | 0.8x6.35 | 6.6 | 7.6 | 16.0 | 2.3 | Mavi | 1.5 ~2.5 mm ² 15A | 100 | 5,54 |
| 014 100 144060 | TEDT-4-6 | 0.8x6.35 | 7.0 | 7.6 | 17.5 | 3.4 | Sarı | 4 ~6 mm ² 24A | 100 | 18,82 |

POLYAMİD TAM İZOLELİ DİŞİ TERMİNAL



Malzeme : Piriç
 İzolasyon : Nylon
 Voltaj : <600V
 Sıcaklık : 105° 400V

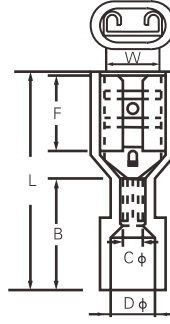

| Ürün Kodu | Model Kodu | Soket Ölçüsü | Ebatlar | | | | | | Renk | Kutu Adet | Fiyat (Adet/₺) |
|----------------|------------------|--------------|---------|------|------|------|-----|-----|---------|-----------|----------------|
| | | | W | F | L | B | DØ | CØ | | | |
| 014 100 150510 | TDTP-0,5-1/6.4 | 0.8x6.35 | 8.4 | 10.5 | 22.6 | 11.0 | 4.0 | 1.7 | Kırmızı | 200 | 7,49 |
| 014 100 151525 | TDTP-1,5-2,5/6.4 | 0.8x6.35 | 8.4 | 10.5 | 22.6 | 11.0 | 4.5 | 2.3 | Mavi | 200 | 7,49 |
| 014 100 154060 | TDTP-4-6 | 0.8x6.35 | 8.6 | 10.5 | 24.0 | 13.0 | 6.3 | 3.4 | Sarı | 100 | 8,98 |



FASTON TİP TERMİNALLER İZOLESİZ

| Ürün Kodu | Ürün Adı | Adet | Fiyat (₺) |
|----------------|--|------|-----------|
| 065 100 140002 | TSF-1-D MİNİ 4,8 FASTON TİP TERMİNAL | 500 | 1,38 |
| 065 100 140003 | TSF-1-D 6,3 FASTON TİP TERMİNAL İZOLESİZ | 300 | 1,61 |
| 065 100 140004 | TSF-1-E FASTON TİP TERMİNAL | 300 | 1,80 |



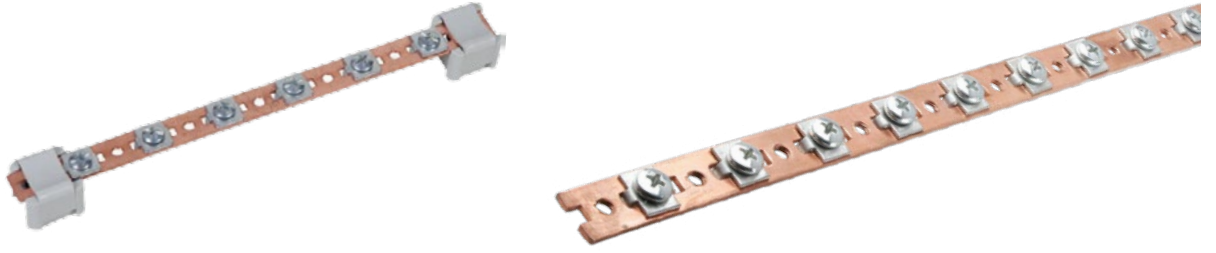

TOPRAKLAMA BARASI VE MESNEDİ

| Ürün Kodu | Ürün Adı | Adet | Fiyat (₺) |
|----------------|------------------------------------|------|-----------|
| 034 025 040000 | TOPRAKLAMA BARASI 1,5 mm (31 VİDA) | 40 | 834,10 |
| 034 025 100001 | TOPRAKLAMA BARASI MESNEDİ | 100 | 9,00 |

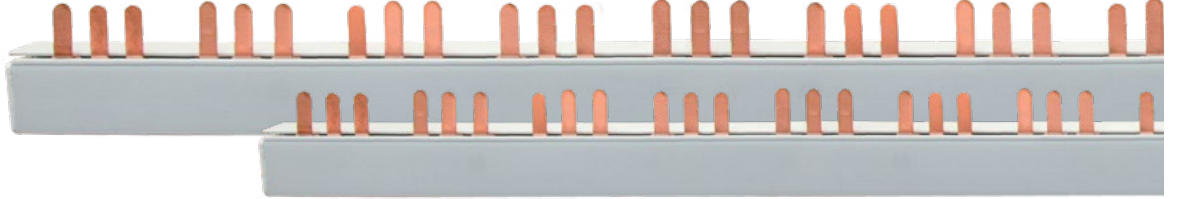

TRİFAZE BARALAR

| Ürün Kodu | Ürün Adı | Adet | Fiyat (₺) |
|----------------|--|------|-----------|
| 034 025 040004 | TRİFAZE MÜŞTEREK BARA İĞNE UÇLU 80A - 53 cm | 24 | 709,90 |
| 034 025 040005 | TRİFAZE MÜŞTEREK BARA İĞNE UÇLU 63A - 53 cm | 24 | 638,90 |
| 034 025 040006 | TRİFAZE MÜŞTEREK BARA İĞNE UÇLU 80A - 106 cm | 24 | 1.419,70 |
| 034 025 040007 | TRİFAZE MÜŞTEREK BARA İĞNE UÇLU 63A - 106 cm | 24 | 1.277,80 |



MONOFAZE BARALAR

| Ürün Kodu | Ürün Adı | Adet | Fiyat (₺) |
|----------------|---|------|-----------|
| 034 025 040002 | MONOFAZE MÜŞTEREK BARA İĞNE UÇLU 106 cm | 50 | 567,90 |
| 034 025 040003 | MONOFAZE MÜŞTEREK BARA İĞNE UÇLU 53 cm | 50 | 291,70 |

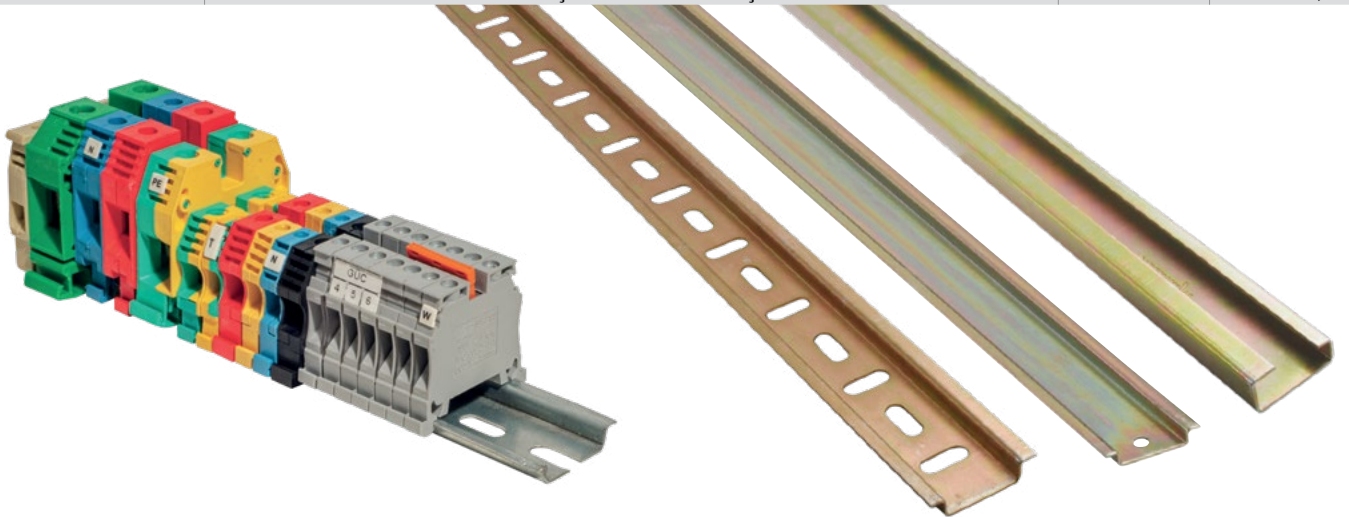

RAYLAR

| Ürün Kodu | Ürün Adı | Adet | Fiyat (₺) |
|----------------------|--|-----------|-----------|
| 001 025 020100 00 00 | KLEMENS RAYI(1mt.) | 25 mt. | 165,90 |
| 001 025 000100 00 00 | W OTOMAT RAYI(1M) (1mt. Fiyatı) | 50 mt. | 83,60 |
| 001 025 000200 00 00 | W OTOMAT RAYI(2M) (1mt. Fiyatı) | 50 mt. | 83,60 |
| 001 025 000033 00 00 | W OTOMAT RAYI (33 cm) | CE 50 mt. | 28,60 |
| 001 025 900100 00 00 | W OTOMAT RAYI(DELİKLİ)(1M)(1mt Fiyatı) | CE 50 mt. | 91,80 |
| 001 025 900200 00 00 | W OTOMAT RAYI(DELİKLİ)(2M)(1mt Fiyatı) | CE 50 mt. | 91,80 |

EKO KABLO PABUÇLARI

| Ürün Kodu | Ürün Adı | Çivata | D3 | D2 | D1 | L | A | Kutu Adet | Fiyat (₺) |
|----------------|-----------------------------|--------|------|------|------|----|------|-----------|-----------|
| 123 037 000016 | 16-06 EKO TİP KABLO PABUCU | M6 | 6,5 | 5,8 | 7,4 | 30 | 12 | 500 | 17,70 |
| 123 037 000025 | 25-08 EKO TİP KABLO PABUCU | M8 | 8,5 | 7 | 9,2 | 40 | 14 | 350 | 30,20 |
| 123 037 000035 | 35-08 EKO TİP KABLO PABUCU | M8 | 8,5 | 8,2 | 10,7 | 44 | 15,3 | 200 | 39,00 |
| 123 037 000050 | 50-10 EKO TİP KABLO PABUCU | M10 | 10,5 | 10,2 | 12,8 | 52 | 20 | 150 | 53,20 |
| 123 037 000070 | 70-10 EKO TİP KABLO PABUCU | M10 | 10,5 | 11,7 | 14,7 | 55 | 22 | 100 | 83,40 |
| 123 037 000095 | 95-12 EKO TİP KABLO PABUCU | M12 | 13 | 13,6 | 16,7 | 59 | 26 | 70 | 95,80 |
| 123 037 000120 | 120-12 EKO TİP KABLO PABUCU | M12 | 13 | 15,5 | 19 | 70 | 29 | 50 | 134,90 |
| 123 037 000150 | 150-12 EKO TİP KABLO PABUCU | M12 | 13 | 16,7 | 21 | 77 | 32 | 40 | 195,20 |
| 123 037 000185 | 185-16 EKO TİP KABLO PABUCU | M16 | 17 | 18,8 | 23 | 85 | 35 | 30 | 239,60 |
| 123 037 000240 | 240-16 EKO TİP KABLO PABUCU | M16 | 17 | 21,2 | 26 | 90 | 38,5 | 24 | 390,40 |

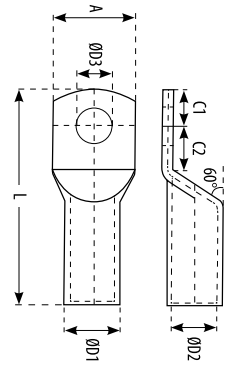

STANDART KABLO PABUÇLARI

| Ürün Kodu | Ürün Adı | Çivata | D3 | D2 | D1 | L | A | Kutu Adet | Fiyat (₺) |
|----------------|----------------------------------|--------|------|------|------|------|------|-----------|-----------|
| 123 037 500010 | 10-05 STANDART TİP KABLO PABUCU | M5 | 5,2 | 4,7 | 6,5 | 27,5 | 10,5 | 800 | 19,50 |
| 123 037 500011 | 10-06 STANDART TİP KABLO PABUCU | M6 | 6,5 | 4,7 | 6,5 | 27,5 | 10,5 | 800 | 19,50 |
| 123 037 500012 | 10-08 STANDART TİP KABLO PABUCU | M8 | 8,5 | 4,7 | 6,5 | 27,5 | 10,5 | 800 | 19,50 |
| 123 037 500016 | 16-06 STANDART TİP KABLO PABUCU | M6 | 6,5 | 5,8 | 7,4 | 30 | 12 | 500 | 24,80 |
| 123 037 500017 | 16-08 STANDART TİP KABLO PABUCU | M8 | 8,5 | 5,8 | 7,8 | 30 | 12 | 500 | 24,80 |
| 123 037 500018 | 16-10 STANDART TİP KABLO PABUCU | M10 | 10,5 | 5,8 | 7,8 | 30 | 12 | 500 | 24,80 |
| 123 037 500024 | 25-06 STANDART TİP KABLO PABUCU | M6 | 6,5 | 7 | 9,2 | 40 | 14 | 350 | 40,80 |
| 123 037 500025 | 25-08 STANDART TİP KABLO PABUCU | M8 | 8,5 | 7 | 9,2 | 40 | 14 | 350 | 40,80 |
| 123 037 500026 | 25-10 STANDART TİP KABLO PABUCU | M10 | 10,5 | 7 | 9,5 | 40 | 14 | 350 | 40,80 |
| 123 037 500034 | 35-06 STANDART TİP KABLO PABUCU | M6 | 6,5 | 8,2 | 10,7 | 44 | 15,3 | 200 | 56,80 |
| 123 037 500035 | 35-08 STANDART TİP KABLO PABUCU | M8 | 8,5 | 8,2 | 10,7 | 44 | 15,3 | 200 | 56,80 |
| 123 037 500036 | 35-10 STANDART TİP KABLO PABUCU | M10 | 10,5 | 8,2 | 10,7 | 44 | 15,3 | 200 | 56,80 |
| 123 037 500037 | 35-12 STANDART TİP KABLO PABUCU | M12 | 13 | 8,2 | 10,7 | 44 | 15,3 | 200 | 56,80 |
| 123 037 500049 | 50-08 STANDART TİP KABLO PABUCU | M8 | 8,5 | 10,2 | 12,8 | 52 | 20 | 150 | 81,60 |
| 123 037 500050 | 50-10 STANDART TİP KABLO PABUCU | M10 | 10,5 | 10,2 | 12,8 | 52 | 20 | 150 | 81,60 |
| 123 037 500051 | 50-12 STANDART TİP KABLO PABUCU | M12 | 13 | 10,2 | 12,8 | 52 | 20 | 150 | 81,60 |
| 123 037 500069 | 70-08 STANDART TİP KABLO PABUCU | M8 | 8,5 | 11,7 | 14,7 | 55 | 22 | 100 | 111,80 |
| 123 037 500070 | 70-10 STANDART TİP KABLO PABUCU | M10 | 10,5 | 11,7 | 14,7 | 55 | 22 | 100 | 111,80 |
| 123 037 500071 | 70-12 STANDART TİP KABLO PABUCU | M12 | 13 | 11,7 | 14,7 | 55 | 22 | 100 | 111,80 |
| 123 037 500094 | 95-10 STANDART TİP KABLO PABUCU | M10 | 10,5 | 13,6 | 16,7 | 59 | 26 | 70 | 136,60 |
| 123 037 500095 | 95-12 STANDART TİP KABLO PABUCU | M12 | 13 | 13,6 | 16,7 | 59 | 26 | 70 | 136,60 |
| 123 037 500119 | 120-10 STANDART TİP KABLO PABUCU | M10 | 10,5 | 15,5 | 19 | 70 | 29 | 50 | 195,20 |
| 123 037 500120 | 120-12 STANDART TİP KABLO PABUCU | M12 | 13 | 15,5 | 19 | 70 | 29 | 50 | 195,20 |
| 123 037 500149 | 150-10 STANDART TİP KABLO PABUCU | M10 | 10,5 | 16,7 | 21 | 77 | 32 | 40 | 292,80 |
| 123 037 500150 | 150-12 STANDART TİP KABLO PABUCU | M12 | 13 | 16,7 | 21 | 77 | 32 | 40 | 292,80 |
| 123 037 500183 | 185-10 STANDART TİP KABLO PABUCU | M10 | 10,5 | 18,8 | 23 | 85 | 35 | 30 | 354,90 |
| 123 037 500184 | 185-12 STANDART TİP KABLO PABUCU | M12 | 13 | 18,8 | 23 | 85 | 35 | 30 | 354,90 |
| 123 037 500185 | 185-16 STANDART TİP KABLO PABUCU | M16 | 17 | 18,8 | 23 | 85 | 35 | 30 | 354,90 |
| 123 037 500238 | 240-10 STANDART TİP KABLO PABUCU | M10 | 10,5 | 21,2 | 26 | 90 | 38,5 | 24 | 461,40 |
| 123 037 500239 | 240-12 STANDART TİP KABLO PABUCU | M12 | 13 | 21,2 | 26 | 90 | 38,5 | 24 | 461,40 |
| 123 037 500240 | 240-16 STANDART TİP KABLO PABUCU | M16 | 17 | 21,2 | 26 | 90 | 38,5 | 24 | 461,40 |
| 123 037 500299 | 300-12 STANDART TİP KABLO PABUCU | M12 | 13 | 23,5 | 28,6 | 100 | 43 | 20 | 559,00 |
| 123 037 500300 | 300-16 STANDART TİP KABLO PABUCU | M16 | 17 | 23,5 | 28,6 | 100 | 43 | 20 | 559,00 |



BORU TİP SIKMALI EK MUFLAR

| Ürün Kodu | Ürün Adı | D2 | D3 | L | Kutu Adet | Fiyat (₺) |
|----------------|---|------|------|----|-----------|-----------|
| 123 037 300016 | 16 mm ² BORU TİP SIKMALI EK MUF | 5,8 | 7,4 | 30 | 500 | 19,50 |
| 123 037 300025 | 25 mm ² BORU TİP SIKMALI EK MUF | 7,2 | 9,2 | 40 | 300 | 31,90 |
| 123 037 300035 | 35 mm ² BORU TİP SIKMALI EK MUF | 8,5 | 11 | 44 | 200 | 40,80 |
| 123 037 300050 | 50 mm ² BORU TİP SIKMALI EK MUF | 10 | 13 | 52 | 150 | 53,20 |
| 123 037 300070 | 70 mm ² BORU TİP SIKMALI EK MUF | 11,5 | 14,7 | 55 | 100 | 85,20 |
| 123 037 300095 | 95 mm ² BORU TİP SIKMALI EK MUF | 13,5 | 16,7 | 59 | 70 | 102,90 |
| 123 037 300120 | 120 mm ² BORU TİP SIKMALI EK MUF | 15,6 | 19 | 70 | 50 | 136,60 |
| 123 037 300150 | 150 mm ² BORU TİP SIKMALI EK MUF | 17 | 21 | 77 | 40 | 213,00 |
| 123 037 300185 | 185 mm ² BORU TİP SIKMALI EK MUF | 19 | 23 | 85 | 30 | 257,30 |
| 123 037 300240 | 240 mm ² BORU TİP SIKMALI EK MUF | 21 | 26 | 90 | 24 | 381,60 |



MUTLUSAN SANAYİ TİPİ FİŞ - PRİZ GRUBU (MONOFAZE 1x16A)

| | |
|--|--|
|  | <p>ÜRÜN KODU 010 083 300027</p> <p>ÜRÜN ADI MUT-27 1x16 A MONO. TOP. ERKEK FİŞ (EĞİK)</p> <p>ADET/KOLİ 40/320</p> <p>FİYAT (₺) 70,30</p> |
|--|--|

| | |
|---|---|
|  | <p>ÜRÜN KODU 010 083 300028</p> <p>ÜRÜN ADI MUT-28 1x16 A MONO. TOP. ERKEK FİŞ (DÜZ)</p> <p>ADET/KOLİ 40/320</p> <p>FİYAT (₺) 70,30</p> |
|---|---|

| | |
|---|---|
|  | <p>ÜRÜN KODU 010 083 300029</p> <p>ÜRÜN ADI MUT-29 1x16 A MONO. TOP. DİŞİ FİŞ</p> <p>ADET/KOLİ 25/200</p> <p>FİYAT (₺) 105,40</p> |
|---|---|

| | |
|--|---|
|  | <p>ÜRÜN KODU 010 083 500296</p> <p>ÜRÜN ADI MUT-29/6 1x16 A MONO. TOP. DUVAR PRİZ</p> <p>ADET/KOLİ 20/160</p> <p>FİYAT (₺) 133,50</p> |
|--|---|

| | |
|---|---|
|  | <p>ÜRÜN KODU 010 083 500293</p> <p>ÜRÜN ADI MUT-29/3 1x16 A MONO. 3'LÜ GRUP PRİZ</p> <p>ADET/KOLİ 12/96</p> <p>FİYAT (₺) 216,50</p> |
|---|---|

| | |
|---|---|
|  | <p>ÜRÜN KODU 010 083 500294</p> <p>ÜRÜN ADI MUT-29/4 1x16 A MONO. 4'LÜ GRUP PRİZ</p> <p>ADET/KOLİ 10/80</p> <p>FİYAT (₺) 270,70</p> |
|---|---|

| | |
|---|--|
|  | <p>ÜRÜN KODU 010 083 501292</p> <p>ÜRÜN ADI MUT-29/2A 1x16 A MONO. 2'Lİ GRUP PRİZ ANAHTARLI</p> <p>ADET/KOLİ 12/96</p> <p>FİYAT (₺) 387,90</p> |
|---|--|

| | |
|--|--|
|  | <p>ÜRÜN KODU 010 083 501293</p> <p>ÜRÜN ADI MUT-29/3A 1x16 A MONO. 3'LÜ GRUP PRİZ ANAHTARLI</p> <p>ADET/KOLİ 10/80</p> <p>FİYAT (₺) 465,40</p> |
|--|--|

| | |
|--|--|
|  | <p>ÜRÜN KODU 010 083 500292</p> <p>ÜRÜN ADI MUT-29/2 1x16 A MONO. 2'Lİ GRUP PRİZ</p> <p>ADET/KOLİ 14/112</p> <p>FİYAT (₺) 166,30</p> |
|--|--|

MUTLUSAN SANAYİ TİPİ FİŞ - PRİZ GRUBU (TRİFAZE 3x25A)

| | |
|---|---|
|  | <p>ÜRÜN KODU 010 083 400030</p> <p>ÜRÜN ADI MUT-30 3x25 A TRİFAZE ERKEK FİŞ</p> <p>ADET/KOLİ 25/200</p> <p>FİYAT (₺) 133,50</p> |
|---|---|

| | |
|---|--|
|  | <p>ÜRÜN KODU 010 083 400031</p> <p>ÜRÜN ADI MUT-31 3x25 A TRİFAZE DİŞİ İŞ (SEYYAR)</p> <p>ADET/KOLİ 20/160</p> <p>FİYAT (₺) 210,50</p> |
|---|--|

| | |
|---|---|
|  | <p>ÜRÜN KODU 010 083 600315</p> <p>ÜRÜN ADI MUT-31/5 3x25 A TRİFAZE DUVAR PRİZİ</p> <p>ADET/KOLİ 20/160</p> <p>FİYAT (₺) 249,50</p> |
|---|---|

| | |
|--|---|
|  | <p>ÜRÜN KODU 010 083 600311</p> <p>ÜRÜN ADI MUT-31/1 1 TRİFAZE + 1 MONOFAZE GR. PRİZ</p> <p>ADET/KOLİ 10/80</p> <p>FİYAT (₺) 453,30</p> |
|--|---|

| | |
|---|---|
|  | <p>ÜRÜN KODU 010 083 600312</p> <p>ÜRÜN ADI MUT-31/2 TRİFAZE GRUP PRİZ -2'Lİ</p> <p>ADET/KOLİ 10/80</p> <p>FİYAT (₺) 502,00</p> |
|---|---|

| | |
|---|---|
|  | <p>ÜRÜN KODU 010 083 600313</p> <p>ÜRÜN ADI MUT-31/3 TRİFAZE GRUP PRİZ -3'LÜ</p> <p>ADET/KOLİ 10/80</p> <p>FİYAT (₺) 572,30</p> |
|---|---|

| | |
|--|---|
|  | <p>ÜRÜN KODU 010 083 600316</p> <p>ÜRÜN ADI MUT-31/6 2 TRİFAZE + 1 MONOFAZE GR. PRİZ</p> <p>ADET/KOLİ 10/80</p> <p>FİYAT (₺) 572,30</p> |
|--|---|

| | |
|---|---|
|  | <p>ÜRÜN KODU 010 083 600317</p> <p>ÜRÜN ADI MUT-31/7 1 TRİFAZE + 2 MONOFAZE GR. PRİZ</p> <p>ADET/KOLİ 10/80</p> <p>FİYAT (₺) 572,30</p> |
|---|---|

MUTLUSAN SANAYİ TİPİ FİŞ - PRİZ GRUBU (TRİFAZE 3x16A)

CE

| | |
|-----------|---------------------------------|
| ÜRÜN KODU | 010 083 400060 |
| ÜRÜN ADI | MUT-60 3x16 A TRİFAZE ERKEK FİŞ |
| ADET/KOLİ | 30/240 |
| FİYAT (₺) | 232,10 |



CE

| | |
|-----------|---------------------------------------|
| ÜRÜN KODU | 010 083 400061 |
| ÜRÜN ADI | MUT-61 3x16 A TRİFAZE SEYYAR DİŞİ FİŞ |
| ADET/KOLİ | 25/200 |
| FİYAT (₺) | 283,90 |



CE

| | |
|-----------|-----------------------------------|
| ÜRÜN KODU | 010 083 400062 |
| ÜRÜN ADI | MUT-62 3x16 A TRİFAZE DUVAR PRİZİ |
| ADET/KOLİ | 20/160 |
| FİYAT (₺) | 355,80 |



MUTLUSAN SANAYİ TİPİ FİŞ - PRİZ GRUBU (TRİFAZE 3x32A)

CE

| | |
|-----------|---------------------------------|
| ÜRÜN KODU | 010 083 400070 |
| ÜRÜN ADI | MUT-70 3x32 A TRİFAZE ERKEK FİŞ |
| ADET/KOLİ | 20/160 |
| FİYAT (₺) | 335,20 |



CE

| | |
|-----------|---------------------------------------|
| ÜRÜN KODU | 010 083 400071 |
| ÜRÜN ADI | MUT-71 3x32 A TRİFAZE SEYYAR DİŞİ FİŞ |
| ADET/KOLİ | 15/120 |
| FİYAT (₺) | 382,00 |



CE

| | |
|-----------|-----------------------------------|
| ÜRÜN KODU | 010 083 400072 |
| ÜRÜN ADI | MUT-72 3x32 A TRİFAZE DUVAR PRİZİ |
| ADET/KOLİ | 20/160 |
| FİYAT (₺) | 502,90 |



KABLO MAKARASI

| Ürün Kodu | Ürün Adı | Kutu Adet | Koli Adet | Fiyat (\$) |
|----------------|--|-----------|-----------|------------|
| 005 083 700045 | MONOFAZE PLS. BOŞ MAKARA 50 mt. KAPASİTELİ (4 MONOFAZE PRİZLİ) | 1 | 1 | 23,70 \$ |



MUTLUSAN CEE NORM SANAYİ TİPİ FİŞ - PRİZ GRUBU



| | | |
|-----|-----------|---------------------------------|
| CEE | ÜRÜN KODU | 010 083 000316 |
| | ÜRÜN ADI | MUT-301 CEE NORM 3/16 A DÜZ FİŞ |
| | ADET/KOLİ | 16/128 |
| | FİYAT (₺) | 228,40 |



| | | |
|-----|-----------|-----------------------------------|
| CEE | ÜRÜN KODU | 010 083 010316 |
| | ÜRÜN ADI | MUT-302 CEE NORM 3/16 UZATMA PRİZ |
| | ADET/KOLİ | 15/120 |
| | FİYAT (₺) | 265,30 |



| | | |
|-----|-----------|------------------------------------|
| CEE | ÜRÜN KODU | 010 083 020316 |
| | ÜRÜN ADI | MUT-303 CEE NORM 3/16 MAKİNE PRİZİ |
| | ADET/KOLİ | 20/160 |
| | FİYAT (₺) | 250,70 |



| | | |
|-----|-----------|-----------------------------------|
| CEE | ÜRÜN KODU | 010 083 030316 |
| | ÜRÜN ADI | MUT-304 CEE NORM 3/16 DUVAR PRİZİ |
| | ADET/KOLİ | 8/64 |
| | FİYAT (₺) | 335,70 |



| | | |
|-----|-----------|---------------------------------|
| CEE | ÜRÜN KODU | 010 083 000416 |
| | ÜRÜN ADI | MUT-401 CEE NORM 4/16 A DÜZ FİŞ |
| | ADET/KOLİ | 16/128 |
| | FİYAT (₺) | 281,10 |



| | | |
|-----|-----------|-------------------------------------|
| CEE | ÜRÜN KODU | 010 083 010416 |
| | ÜRÜN ADI | MUT-402 CEE NORM 4/16 A UZATMA PRİZ |
| | ADET/KOLİ | 15/120 |
| | FİYAT (₺) | 351,40 |



| | | |
|-----|-----------|--|
| CEE | ÜRÜN KODU | 010 083 020416 |
| | ÜRÜN ADI | MUT-403 CEE NORM 4/16 A MAKİNE PRİZİ (YENİ ÜRÜN) |
| | ADET/KOLİ | 20/160 |
| | FİYAT (₺) | 312,70 |



| | | |
|-----|-----------|---|
| CEE | ÜRÜN KODU | 010 083 030416 |
| | ÜRÜN ADI | MUT-404 CEE NORM 4/16 A DUVAR PRİZİ (YENİ ÜRÜN) |
| | ADET/KOLİ | 8/64 |
| | FİYAT (₺) | 398,20 |



| | | |
|-----|-----------|---------------------------------|
| CEE | ÜRÜN KODU | 010 083 000516 |
| | ÜRÜN ADI | MUT-101 CEE NORM 5x16 A DÜZ FİŞ |
| | ADET/KOLİ | 16/128 |
| | FİYAT (₺) | 301,50 |



| | | |
|-----|-----------|--------------------------------------|
| CEE | ÜRÜN KODU | 010 083 020516 |
| | ÜRÜN ADI | MUT-103 CEE NORM 5x16 A MAKİNE PRİZİ |
| | ADET/KOLİ | 20/160 |
| | FİYAT (₺) | 339,10 |



| | | |
|-----|-----------|--------------------------------------|
| CEE | ÜRÜN KODU | 010 083 010516 |
| | ÜRÜN ADI | MUT-102 CEE NORM 5x16 A UZATMA PRİZİ |
| | ADET/KOLİ | 15/120 |
| | FİYAT (₺) | 383,00 |



| | | |
|-----|-----------|-------------------------------------|
| CEE | ÜRÜN KODU | 010 083 030516 |
| | ÜRÜN ADI | MUT-104 CEE NORM 5x16 A DUVAR PRİZİ |
| | ADET/KOLİ | 8/64 |
| | FİYAT (₺) | 422,10 |

MUTLUSAN CEE NORM SANAYİ TİPİ FİŞ - PRİZ GRUBU



| | | |
|----|-----------|---------------------------------|
| CE | ÜRÜN KODU | 010 083 000332 |
| | ÜRÜN ADI | MUT-310 CEE NORM 3/32 A DÜZ FİŞ |
| | ADET/KOLİ | 12/112 |
| | FİYAT (₺) | 344,40 |



| | | |
|----|-----------|-----------------------------------|
| CE | ÜRÜN KODU | 010 083 010332 |
| | ÜRÜN ADI | MUT-320 CEE NORM 3/32 UZATMA PRİZ |
| | ADET/KOLİ | 12/96 |
| | FİYAT (₺) | 369,20 |



| | | |
|----|-----------|------------------------------------|
| CE | ÜRÜN KODU | 010 083 020332 |
| | ÜRÜN ADI | MUT-330 CEE NORM 3/32 MAKİNE PRİZİ |
| | ADET/KOLİ | 14/112 |
| | FİYAT (₺) | 323,30 |



| | | |
|----|-----------|-----------------------------------|
| CE | ÜRÜN KODU | 010 083 030332 |
| | ÜRÜN ADI | MUT-340 CEE NORM 3/32 DUVAR PRİZİ |
| | ADET/KOLİ | 8/64 |
| | FİYAT (₺) | 409,50 |



| | | |
|----|-----------|---------------------------------|
| CE | ÜRÜN KODU | 010 083 000432 |
| | ÜRÜN ADI | MUT-410 CEE NORM 4/32 A DÜZ FİŞ |
| | ADET/KOLİ | 14/112 |
| | FİYAT (₺) | 386,50 |



| | | |
|----|-----------|-------------------------------------|
| CE | ÜRÜN KODU | 010 083 010432 |
| | ÜRÜN ADI | MUT-420 CEE NORM 4/32 A UZATMA PRİZ |
| | ADET/KOLİ | 12/96 |
| | FİYAT (₺) | 423,50 |



| | | |
|----|-----------|--------------------------------------|
| CE | ÜRÜN KODU | 010 083 020432 |
| | ÜRÜN ADI | MUT-430 CEE NORM 4/32 A MAKİNE PRİZİ |
| | ADET/KOLİ | 14/112 |
| | FİYAT (₺) | 370,70 |



| | | |
|----|-----------|-------------------------------------|
| CE | ÜRÜN KODU | 010 083 030432 |
| | ÜRÜN ADI | MUT-440 CEE NORM 4/32 A DUVAR PRİZİ |
| | ADET/KOLİ | 8/64 |
| | FİYAT (₺) | 455,10 |



| | | |
|----|-----------|---------------------------------|
| CE | ÜRÜN KODU | 010 083 000532 |
| | ÜRÜN ADI | MUT-201 CEE NORM 5x32 A DÜZ FİŞ |
| | ADET/KOLİ | 14/112 |
| | FİYAT (₺) | 404,10 |



| | | |
|----|-----------|--------------------------------------|
| CE | ÜRÜN KODU | 010 083 020532 |
| | ÜRÜN ADI | MUT-203 CEE NORM 5x32 A MAKİNE PRİZİ |
| | ADET/KOLİ | 14/112 |
| | FİYAT (₺) | 407,60 |



| | | |
|----|-----------|--------------------------------------|
| CE | ÜRÜN KODU | 010 083 010532 |
| | ÜRÜN ADI | MUT-202 CEE NORM 5x32 A UZATMA PRİZİ |
| | ADET/KOLİ | 12/96 |
| | FİYAT (₺) | 468,50 |



| | | |
|----|-----------|-------------------------------------|
| CE | ÜRÜN KODU | 010 083 030532 |
| | ÜRÜN ADI | MUT-204 CEE NORM 5x32 A DUVAR PRİZİ |
| | ADET/KOLİ | 8/64 |
| | FİYAT (₺) | 490,20 |

MUTLUSAN SANAYİ TİPİ FİŞ - PRİZ GRUBU (MONOFAZE 1x16A)



CE

| | |
|-----------|---|
| ÜRÜN KODU | 010 083 500298 |
| ÜRÜN ADI | MUT-29/8 MONOFAZE TOP. PANO PRİZİ |
| ADET/KOLİ | 40/320 |
| FİYAT (₺) | 71,90 |



CE

| | |
|-----------|-------------------------------------|
| ÜRÜN KODU | 010 083 500297 |
| ÜRÜN ADI | MUT-29/7 MONOFAZE DUVAR PRİZİ |
| ADET/KOLİ | 30/240 |
| FİYAT (₺) | 116,00 |



CE

| | |
|-----------|--------------------------------------|
| ÜRÜN KODU | 010 083 500299 |
| ÜRÜN ADI | MUT-29/9 MONOFAZE MAKİNE PRİZİ |
| ADET/KOLİ | 20/160 |
| FİYAT (₺) | 146,20 |



CE

| | |
|-----------|--------------------------------------|
| ÜRÜN KODU | 010 083 502910 |
| ÜRÜN ADI | MUT-29/10 MONOFAZE DUVAR PRİZİ |
| ADET/KOLİ | 15/120 |
| FİYAT (₺) | 194,20 |

MUTLUSAN SANAYİ TİPİ FİŞ - PRİZ GRUBU (TRİFAZE 3x16A)



CE

| | |
|-----------|--|
| ÜRÜN KODU | 010 083 400064 |
| ÜRÜN ADI | MUT-64 3x16 TRİFAZE MAKİNE PRİZİ |
| ADET/KOLİ | 20/160 |
| FİYAT (₺) | 232,80 |



CE

| | |
|-----------|---------------------------------------|
| ÜRÜN KODU | 010 083 400063 |
| ÜRÜN ADI | MUT-63 3x16 TRİFAZE DUVAR PRİZİ |
| ADET/KOLİ | 12/96 |
| FİYAT (₺) | 260,70 |

MUTLUSAN SANAYİ TİPİ FİŞ - PRİZ GRUBU (TRİFAZE 3x25A)



CE

| | |
|-----------|--|
| ÜRÜN KODU | 010 083 400318 |
| ÜRÜN ADI | MUT-31/8 3x25 TRİFAZE MAKİNE PRİZİ |
| ADET/KOLİ | 20/160 |
| FİYAT (₺) | 195,70 |



CE

| | |
|-----------|---|
| ÜRÜN KODU | 010 083 400319 |
| ÜRÜN ADI | MUT-31/9 3x25 TRİFAZE DUVAR PRİZİ |
| ADET/KOLİ | 15/120 |
| FİYAT (₺) | 249,50 |

MUTLUSAN SANAYİ TİPİ FİŞ - PRİZ GRUBU (TRİFAZE 3x32A)



CE

| | |
|-----------|--|
| ÜRÜN KODU | 010 083 400074 |
| ÜRÜN ADI | MUT-74 3x32 TRİFAZE MAKİNE PRİZİ |
| ADET/KOLİ | 20/160 |
| FİYAT (₺) | 286,10 |



CE

| | |
|-----------|---------------------------------------|
| ÜRÜN KODU | 010 083 400073 |
| ÜRÜN ADI | MUT-73 3x32 TRİFAZE DUVAR PRİZİ |
| ADET/KOLİ | 12/96 |
| FİYAT (₺) | 335,20 |

SİNTAŞ SANAYİ TİPİ FİŞ - PRİZLER

| Ürün Kodu | Ürün Adı | Kutu Adet | Koli Adet | Fiyat (₺) |
|----------------|-----------------------------|-----------|-----------|-----------|
| 019 107 016250 | 16X25 A.4 KUTUPLU FİŞ-PRİZ | 1 | 30 | 983,90 |
| 019 107 016252 | 16X25 A.4 KUTUPLU PRİZ | 1 | 45 | 516,50 |
| 019 107 016251 | 16X25 A.4 KUTUPLU FİŞ | 1 | 60 | 467,30 |
| 019 107 025400 | 25x40 A.4 KUTUPLU FİŞ-PRİZ | 1 | 15 | 1.279,10 |
| 019 107 025402 | 25x40 A.4 KUTUPLU PRİZ | 1 | 25 | 664,10 |
| 019 107 025401 | 25x40 A.4 KUTUPLU FİŞ | 1 | 35 | 614,90 |
| 019 107 040630 | 40X63 A.4 KUTUPLU FİŞ-PRİZ | 1 | 10 | 1.648,00 |
| 019 107 040632 | 40X63 A.4 KUTUPLU PRİZ | 1 | 15 | 860,90 |
| 019 107 040631 | 40X63 A.4 KUTUPLU FİŞ | 1 | 25 | 787,10 |
| 019 107 063100 | 63X100 A.4 KUTUPLU FİŞ-PRİZ | 1 | 5 | 2.656,50 |
| 019 107 063102 | 63X100 A.4 KUTUPLU PRİZ | 1 | 10 | 1.377,40 |
| 019 107 063101 | 63X100 A.4 KUTUPLU FİŞ | 1 | 15 | 1.279,10 |



SİNTAŞ SANAYİ TİPİ SEYYAR PRİZLER

| Ürün Kodu | Ürün Adı | Kutu Adet | Koli Adet | Fiyat (₺) |
|----------------|--------------------------------|-----------|-----------|-----------|
| 019 107 016253 | 16X25 A.4 KUTUPLU SEYYAR PRİZ | 1 | 45 | 516,50 |
| 019 107 025403 | 25x40 A.4 KUTUPLU SEYYAR PRİZ | 1 | 25 | 664,10 |
| 019 107 040633 | 40X63 A.4 KUTUPLU SEYYAR PRİZ | 1 | 15 | 860,90 |
| 019 107 063103 | 63X100 A.4 KUTUPLU SEYYAR PRİZ | 1 | 10 | 1.377,40 |

ÇEVRE KOŞULLARINA
DAYANIKLI,
KABLOLAMA ve
MONTAJ KOLAYLIĞI

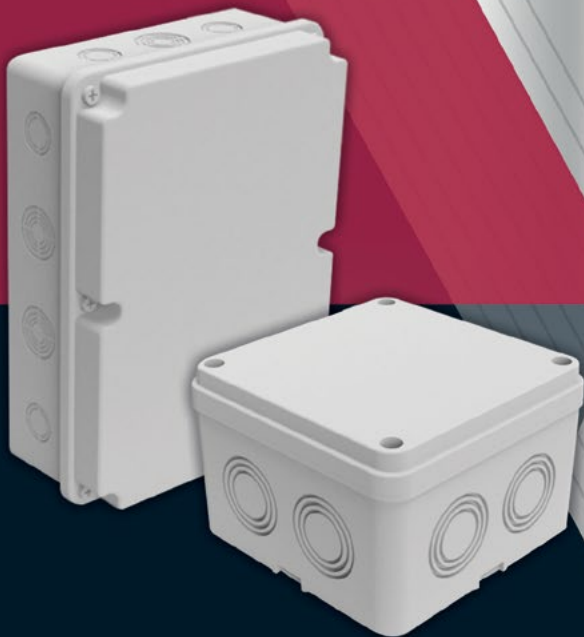

TERMOPLASTİK BUAT

TERMOPLASTİK BUATLAR VE KOMBİNASYON KUTULARI (GRİ-BEYAZ)

IP65

| | |
|-----------|--------------------------|
| ÜRÜN KODU | 001 046 000101 00 00 |
| ÜRÜN ADI | 85x85 KARE ANTİGRON BUAT |
| ADET/KOLİ | 10/300 |
| FİYAT (₺) | 34,80 |



IP65

| | |
|-----------|--|
| ÜRÜN KODU | 001 046 071827 00 17/Gri 001 046 071827 00 00/Beyaz |
| ÜRÜN ADI | 180x270x100 (14 ÇIKIŞ) TERMOPLASTİK BUAT |
| ADET/KOLİ | 2/8 |
| FİYAT (₺) | 366,50 Gri / 438,90 Beyaz |

IP65

| | |
|-----------|-------------------------------|
| ÜRÜN KODU | 001 046 076131 00 17 |
| ÜRÜN ADI | 138x226x131 TERMOPLASTİK BUAT |
| ADET/KOLİ | 1/8 |
| FİYAT (₺) | 365,10 |



IP40

| | |
|-----------|--|
| ÜRÜN KODU | 001 046 078080 00 17/Gri 001 046 078080 00 00/Beyaz |
| ÜRÜN ADI | 80x80x48 (7 ÇIKIŞLI) TERMOPLASTİK BUAT |
| ADET/KOLİ | 18/108 |
| FİYAT (₺) | 44,50 Gri / 48,40 Beyaz |



IP65

| | |
|-----------|--------------------------------|
| ÜRÜN KODU | 001 046 078226 00 17 |
| ÜRÜN ADI | 138x226x127 KOMBİNASYON KUTUSU |
| ADET/KOLİ | 1/8 |
| FİYAT (₺) | 398,00 |



IP65

| | |
|-----------|---------------------------------------|
| ÜRÜN KODU | 001 046 072698 00 44 |
| ÜRÜN ADI | 138x226x98 (ŞEFFAF) TERMOPLASTİK BUAT |
| ADET/KOLİ | 1/8 |
| FİYAT (₺) | 377,20 |



IP40

| | |
|-----------|--|
| ÜRÜN KODU | 001 046 078585 00 17/Gri 001 046 078585 00 00/Beyaz |
| ÜRÜN ADI | 85x85x48 TERMOPLASTİK BUAT |
| ADET/KOLİ | 18/108 |
| FİYAT (₺) | 42,10 Gri / 49,10 Beyaz |



IP65

| | |
|-----------|--------------------------------|
| ÜRÜN KODU | 001 046 075311 00 17 |
| ÜRÜN ADI | 225x311x132 KOMBİNASYON KUTUSU |
| ADET/KOLİ | 1/4 |
| FİYAT (₺) | 657,60 |



IP65

| | |
|-----------|--|
| ÜRÜN KODU | 001 046 076131 00 44 |
| ÜRÜN ADI | 138x226x131 (ŞEFFAF) TERMOPLASTİK BUAT |
| ADET/KOLİ | 1/8 |
| FİYAT (₺) | 387,50 |



IP40

| | |
|-----------|--|
| ÜRÜN KODU | 001 046 070090 00 17/Gri 001 046 070090 00 00/Beyaz |
| ÜRÜN ADI | Ø90 TERMOPLASTİK BUAT |
| ADET/KOLİ | 18/108 |
| FİYAT (₺) | 76,60 Gri / 83,10 Beyaz |

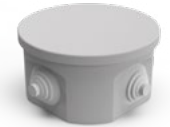

IP65

| | |
|-----------|------------------------------|
| ÜRÜN KODU | 001 046 071199 00 17 |
| ÜRÜN ADI | 225x311x99 TERMOPLASTİK BUAT |
| ADET/KOLİ | 1/4 |
| FİYAT (₺) | 475,60 |



IP65

| | |
|-----------|---------------------------------------|
| ÜRÜN KODU | 001 046 071199 00 44 |
| ÜRÜN ADI | 225x311x99 (ŞEFFAF) TERMOPLASTİK BUAT |
| ADET/KOLİ | 1/4 |
| FİYAT (₺) | 588,60 |



IP65

| | |
|-----------|--|
| ÜRÜN KODU | 001 046 071010 00 17/Gri 001 046 071010 00 00/Beyaz |
| ÜRÜN ADI | 110x110x74 (8 ÇIKIŞ) TERMOPLASTİK BUAT |
| ADET/KOLİ | 10/40 |
| FİYAT (₺) | 104,30 Gri / 120,40 Beyaz |



IP65

| | |
|-----------|-------------------------------|
| ÜRÜN KODU | 001 046 071130 00 17 |
| ÜRÜN ADI | 225x311x130 TERMOPLASTİK BUAT |
| ADET/KOLİ | 1/4 |
| FİYAT (₺) | 516,30 |



IP65

| | |
|-----------|--|
| ÜRÜN KODU | 001 046 071130 00 44 |
| ÜRÜN ADI | 225x311x130 (ŞEFFAF) TERMOPLASTİK BUAT |
| ADET/KOLİ | 1/4 |
| FİYAT (₺) | 610,60 |



IP65

| | |
|-----------|--|
| ÜRÜN KODU | 001 046 071118 00 17/Gri 001 046 071118 00 00/Beyaz |
| ÜRÜN ADI | 110x180x77 (10 ÇIKIŞ) TERMOPL. BUAT |
| ADET/KOLİ | 5/30 |
| FİYAT (₺) | 152,40 Gri / 179,10 Beyaz |



IP65

| | |
|-----------|------------------------------|
| ÜRÜN KODU | 001 046 072698 00 17 |
| ÜRÜN ADI | 138x226x98 TERMOPLASTİK BUAT |
| ADET/KOLİ | 1/8 |
| FİYAT (₺) | 326,20 |



ALEV YAYMAYAN TERMOPLASTİK BUATLAR VE KOMBİNASYON KUTULARI (GRİ-BEYAZ)



IP40



| | |
|-----------|---|
| ÜRÜN KODU | 001 046 098080 00 17 |
| ÜRÜN ADI | 80x80x48 (7 ÇIKIŞLI) TERMOPLASTİK BUAT - A.YAYMAYAN |
| ADET/KOLİ | 18/108 |
| FİYAT (₺) | 76,90 |

IP65



| | |
|-----------|---|
| ÜRÜN KODU | 001 046 098226 00 17 |
| ÜRÜN ADI | 138x226x127 KOMBİNASYON KUTUSU - A.YAYMAYAN |
| ADET/KOLİ | 1/8 |
| FİYAT (₺) | 549,90 |

IP65



| | |
|-----------|--|
| ÜRÜN KODU | 001 046 092698 00 44 |
| ÜRÜN ADI | 138x226x98 (ŞEFFAF) TERMOPLASTİK BUAT - A.YAYMAYAN |
| ADET/KOLİ | 1/8 |
| FİYAT (₺) | 412,10 |

IP40



| | |
|-----------|--|
| ÜRÜN KODU | 001 046 098585 00 17/Gri 001 046 098585 00 00/Beyaz |
| ÜRÜN ADI | 85x85x48 TERMOPLASTİK BUAT - A.YAYMAYAN |
| ADET/KOLİ | 18/108 |
| FİYAT (₺) | 91,30 Gri / 99,90 Beyaz |

IP65



| | |
|-----------|---|
| ÜRÜN KODU | 001 046 095311 00 17 |
| ÜRÜN ADI | 225x311x132 KOMBİNASYON KUTUSU - A.YAYMAYAN |
| ADET/KOLİ | 1/4 |
| FİYAT (₺) | 881,50 |

IP65



| | |
|-----------|---|
| ÜRÜN KODU | 001 046 096131 00 44 |
| ÜRÜN ADI | 138x226x131 (ŞEFFAF) TERMOPLASTİK BUAT - A.YAYMAYAN |
| ADET/KOLİ | 1/8 |
| FİYAT (₺) | 449,20 |

IP40



| | |
|-----------|--|
| ÜRÜN KODU | 001 046 090090 00 17/Gri 001 046 090090 00 00/Beyaz |
| ÜRÜN ADI | Ø90 TERMOPLASTİK BUAT - A.YAYMAYAN |
| ADET/KOLİ | 18/108 |
| FİYAT (₺) | 79,80 Gri / 85,70 Beyaz |

IP65



| | |
|-----------|---|
| ÜRÜN KODU | 001 046 091199 00 17 |
| ÜRÜN ADI | 225x311x99 TERMOPLASTİK BUAT - A.YAYMAYAN |
| ADET/KOLİ | 1/4 |
| FİYAT (₺) | 722,60 |

IP65



| | |
|-----------|--|
| ÜRÜN KODU | 001 046 091199 00 44 |
| ÜRÜN ADI | 225x311x99 (ŞEFFAF) TERMOPLASTİK BUAT - A.YAYMAYAN |
| ADET/KOLİ | 1/4 |
| FİYAT (₺) | 699,50 |

IP65



| | |
|-----------|--|
| ÜRÜN KODU | 001 046 091010 00 17/Gri 001 046 091010 00 00/Beyaz |
| ÜRÜN ADI | 110x110x74 (8 ÇIKIŞ) TERMOPLASTİK BUAT - A.YAYMAYAN |
| ADET/KOLİ | 10/40 |
| FİYAT (₺) | 206,30 Gri / 220,30 Beyaz |

IP65



| | |
|-----------|--|
| ÜRÜN KODU | 001 046 091130 00 17 |
| ÜRÜN ADI | 225x311x130 TERMOPLASTİK BUAT - A.YAYMAYAN |
| ADET/KOLİ | 1/4 |
| FİYAT (₺) | 795,10 |

IP65



| | |
|-----------|---|
| ÜRÜN KODU | 001 046 091130 00 44 |
| ÜRÜN ADI | 225x311x130 (ŞEFFAF) TERMOPLASTİK BUAT - A.YAYMAYAN |
| ADET/KOLİ | 1/4 |
| FİYAT (₺) | 723,60 |

IP65



| | |
|-----------|--|
| ÜRÜN KODU | 001 046 091118 00 17/Gri 001 046 091118 00 00/Beyaz |
| ÜRÜN ADI | 110x180x77 (10 ÇIKIŞ) TERMOPL. BUAT - A.YAYMAYAN |
| ADET/KOLİ | 5/30 |
| FİYAT (₺) | 351,70 Gri / 375,90 Beyaz |

IP65



| | |
|-----------|---|
| ÜRÜN KODU | 001 046 092698 00 17 |
| ÜRÜN ADI | 138x226x98 TERMOPLASTİK BUAT - A.YAYMAYAN |
| ADET/KOLİ | 1/8 |
| FİYAT (₺) | 432,60 |

IP65



| | |
|-----------|--|
| ÜRÜN KODU | 001 046 091827 00 17/Gri 001 046 091827 00 00/Beyaz |
| ÜRÜN ADI | 180x270x100 (14 ÇIKIŞ) TERMOPL. BUAT A.YAYMAYAN |
| ADET/KOLİ | 2/8 |
| FİYAT (₺) | 771,30 Gri / 822,50 Beyaz |

IP65



| | |
|-----------|--|
| ÜRÜN KODU | 001 046 096131 00 17 |
| ÜRÜN ADI | 138x226x131 TERMOPLASTİK BUAT - A.YAYMAYAN |
| ADET/KOLİ | 1/8 |
| FİYAT | 497,10 |

KOMBİNASYON PANOLARI



| | |
|-----------|--|
| ÜRÜN KODU | 010 104 000180 |
| ÜRÜN ADI | MK-325-2 3x25 A 1 ADET ÖN+ 1x16 A 2 ADET YAN |
| ADET/KOLİ | 4 |
| FİYAT (₺) | 742,10 |



| | |
|-----------|--|
| ÜRÜN KODU | 010 104 000181 |
| ÜRÜN ADI | MK-516-1 5x16 A 1 ADET ÖN+ 1x16 A 1 ADET YAN |
| ADET/KOLİ | 6 |
| FİYAT (₺) | 525,70 |



| | |
|-----------|--|
| ÜRÜN KODU | 010 104 000182 |
| ÜRÜN ADI | MK-516-2 5x16 A 1 ADET ÖN+ 1x16 A 2 ADET YAN |
| ADET/KOLİ | 4 |
| FİYAT (₺) | 856,50 |



| | |
|-----------|--|
| ÜRÜN KODU | 010 104 000183 |
| ÜRÜN ADI | MK-532-1 5x32 A 1 ADET ÖN+ 1x16 A 1 ADET YAN |
| ADET/KOLİ | 6 |
| FİYAT (₺) | 572,10 |



| | |
|-----------|--|
| ÜRÜN KODU | 010 104 000184 |
| ÜRÜN ADI | MK-532-2 5x32 A 1 ADET ÖN+ 1x16 A 2 ADET YAN |
| ADET/KOLİ | 4 |
| FİYAT (₺) | 936,90 |



| | |
|-----------|---|
| ÜRÜN KODU | 010 104 000185 |
| ÜRÜN ADI | MK-2325-2 3x25 A 2 ADET ÖN+ 1x16 A 2 ADET YAN |
| ADET/KOLİ | 4 |
| FİYAT (₺) | 1.055,30 |



| | |
|-----------|--|
| ÜRÜN KODU | 010 104 000186 |
| ÜRÜN ADI | MK-2516-2 5x16A 2 ADET ÖN+ 1x16 A 2 ADET YAN |
| ADET/KOLİ | 4 |
| FİYAT (₺) | 1.342,10 |



| | |
|-----------|---|
| ÜRÜN KODU | 010 104 000187 |
| ÜRÜN ADI | MK-2516-4 5x16 A 2 ADET ÖN+ 1x16 A 4 ADET YAN |
| ADET/KOLİ | 4 |
| FİYAT (₺) | 1.522,70 |



| | |
|-----------|---|
| ÜRÜN KODU | 010 104 000188 |
| ÜRÜN ADI | MK-2532-2 5x32 A 2 ADET ÖN+ 1x16 A 2 ADET YAN |
| ADET/KOLİ | 4 |
| FİYAT (₺) | 1.543,40 |



| | |
|-----------|---|
| ÜRÜN KODU | 010 104 000189 |
| ÜRÜN ADI | MK-2532-4 5x32 A 2 ADET ÖN+ 1x16 A 4 ADET YAN |
| ADET/KOLİ | 4 |
| FİYAT (₺) | 1.660,40 |



| | |
|-----------|--|
| ÜRÜN KODU | 010 104 000190 |
| ÜRÜN ADI | MK-5164-4 5x16A 4 ADET ÖN+ 1x16 A 4 ADET YAN |
| ADET/KOLİ | 3 |
| FİYAT (₺) | 2.506,20 |



| | |
|-----------|---|
| ÜRÜN KODU | 010 104 000191 |
| ÜRÜN ADI | MK-5324-4 5x32 A 4 ADET ÖN+ 1x16 A 4 ADET YAN |
| ADET/KOLİ | 3 |
| FİYAT (₺) | 2.780,20 |

KOMBİNASYON KUTULARI



| | |
|-----------|--|
| ÜRÜN KODU | 010 104 000192 |
| ÜRÜN ADI | MK-51632-4 5x16A 2 ADET ÖN+5x32 A 2 AD. ÖN+ 1x16 A 4 ADET YAN |
| ADET/KOLİ | 3 |
| FİYAT (₺) | 2.642,40 |



| | |
|-----------|---|
| ÜRÜN KODU | 001 046 075130 00 17 |
| ÜRÜN ADI | 1'Lİ KOMBİNASYON KUTUSU BOŞ 215x130 GRİ |
| ADET/KOLİ | 1/10 |
| FİYAT (₺) | 418,00 |



| | |
|-----------|---|
| ÜRÜN KODU | 001 046 070220 00 17 |
| ÜRÜN ADI | 2'Lİ KOMBİNASYON KUTUSU BOŞ 290x220 GRİ |
| ADET/KOLİ | 1/4 |
| FİYAT (₺) | 780,60 |

KUTU MONTAJLI ÜRÜNLER



| | |
|-----------|---|
| ÜRÜN KODU | 010 104 000120 |
| ÜRÜN ADI | MS-KK31 1'Lİ KUTULU START BUTONU (1NO) |
| ADET/KOLİ | 18 |
| FİYAT (₺) | 193,40 |



| | |
|-----------|---|
| ÜRÜN KODU | 010 104 000121 |
| ÜRÜN ADI | MS-KK42 1'Lİ KUTULU STOP BUTONU (1NC) |
| ADET/KOLİ | 18 |
| FİYAT (₺) | 193,40 |



| | |
|-----------|---|
| ÜRÜN KODU | 010 104 000122 |
| ÜRÜN ADI | MS-KK51 1'Lİ KUTULU START BUTONU (1NO) |
| ADET/KOLİ | 18 |
| FİYAT (₺) | 193,40 |



| | |
|-----------|---|
| ÜRÜN KODU | 010 104 000123 |
| ÜRÜN ADI | MS-BX71 1'Lİ KUTULU ALARM BUTONU (1NO) |
| ADET/KOLİ | 18 |
| FİYAT (₺) | 201,90 |



| | |
|-----------|--|
| ÜRÜN KODU | 010 104 000124 |
| ÜRÜN ADI | MS-BX81 1'Lİ KUTULU AYDINLATMA BUTONU (1NO) |
| ADET/KOLİ | 18 |
| FİYAT (₺) | 201,90 |



| | |
|-----------|---|
| ÜRÜN KODU | 010 104 000125 |
| ÜRÜN ADI | MS-KK7325 1'Lİ KUTULU İKİZ STOP BUTONU (1NO+1NC) |
| ADET/KOLİ | 18 |
| FİYAT (₺) | 274,60 |



| | |
|-----------|--|
| ÜRÜN KODU | 010 104 000126 |
| ÜRÜN ADI | MS-KK4151 1'Lİ KUTULU İŞARETLİ İKİZ BUTONU (1NO+1NO) |
| ADET/KOLİ | 18 |
| FİYAT (₺) | 282,30 |



| | |
|-----------|---|
| ÜRÜN KODU | 010 104 000127 |
| ÜRÜN ADI | MS-KBZ 1'Lİ KUTULU KABİN ALTI İKAZ LAMBASI BUZZERLİ |
| ADET/KOLİ | 18 |
| FİYAT (₺) | 362,80 |



| | |
|-----------|--|
| ÜRÜN KODU | 010 090 050009 |
| ÜRÜN ADI | MS-BX542 1'Lİ KUTULU ACİL STOP BUTONU (1NC) |
| ADET/KOLİ | 18 |
| FİYAT (₺) | 232,10 |



| | |
|-----------|--|
| ÜRÜN KODU | 010 104 000129 |
| ÜRÜN ADI | MS-BX542E 1'Lİ KUTULU EMERGENCY STOP BUTONU (1NC) |
| ADET/KOLİ | 18 |
| FİYAT (₺) | 239,80 |



| | |
|-----------|---|
| ÜRÜN KODU | 010 104 000130 |
| ÜRÜN ADI | MS-BX542ASP 1'Lİ KUT. MÜHÜRLÜ TİP KOR. ACİL STOP BUTONU (1NC) |
| ADET/KOLİ | 12 |
| FİYAT (₺) | 426,40 |



| | |
|-----------|---|
| ÜRÜN KODU | 010 104 000131 |
| ÜRÜN ADI | MS-BYP3K 1'Lİ KUTULU 3 KADEME BY-PASS ANAHTARI |
| ADET/KOLİ | 12 |
| FİYAT (₺) | 758,10 |



| | |
|-----------|--|
| ÜRÜN KODU | 010 104 000132 |
| ÜRÜN ADI | MS-BYK4K 1'Lİ KUTULU 4 KADEME BY-PASS ANAHTARLI |
| ADET/KOLİ | 12 |
| FİYAT (₺) | 844,70 |



| | |
|-----------|---|
| ÜRÜN KODU | 010 104 000133 |
| ÜRÜN ADI | MS-KANT 1'Lİ KUTULU KAYICI RESET ANAHTARI |
| ADET/KOLİ | 12 |
| FİYAT (₺) | 332,60 |

EKO SERİSİ KUMANDA KUTULARI

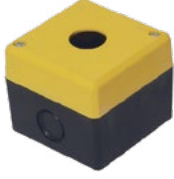

| | |
|-----------|---|
| ÜRÜN KODU | 010 104 000105 |
| ÜRÜN ADI | EKO101S EKO 1'Lİ BOŞ KUMANDA KUTUSU |
| ADET/KOLİ | 90 |
| FİYAT (₺) | 49,50 |



| | |
|-----------|---|
| ÜRÜN KODU | 010 104 000106 |
| ÜRÜN ADI | EKO201S EKO 1'Lİ KORUMALI BOŞ KUMANDA KUTUSU |
| ADET/KOLİ | 50 |
| FİYAT (₺) | 54,20 |



| | |
|-----------|--|
| ÜRÜN KODU | 010 104 000107 |
| ÜRÜN ADI | EKO301S EKO 1'Lİ ACİL STOP ETİ. KOR.YAZILI KUMANDA KUTUSU |
| ADET/KOLİ | 50 |
| FİYAT (₺) | 182,70 |



| | |
|-----------|--|
| ÜRÜN KODU | 010 104 000156 |
| ÜRÜN ADI | EKO401S EKO 1'Lİ ACİL STOPLU KUMANDA KUTUSU |
| ADET/KOLİ | 50 |
| FİYAT (₺) | 178,00 |

BOŞ KUMANDA KUTULARI



| | |
|-----------|------------------------------------|
| ÜRÜN KODU | 010 091 010001 |
| ÜRÜN ADI | 1'Lİ ETANJ BUTON KUTUSU EUROBOX |
| ADET/KOLİ | 24 |
| FİYAT (₺) | 86,20 |



| | |
|-----------|------------------------------------|
| ÜRÜN KODU | 010 091 010002 |
| ÜRÜN ADI | 2'Lİ ETANJ BUTON KUTUSU EUROBOX |
| ADET/KOLİ | 18 |
| FİYAT (₺) | 108,20 |



| | |
|-----------|------------------------------------|
| ÜRÜN KODU | 010 091 010003 |
| ÜRÜN ADI | 3'LÜ ETANJ BUTON KUTUSU EUROBOX |
| ADET/KOLİ | 12 |
| FİYAT (₺) | 145,00 |



| | |
|-----------|------------------------------------|
| ÜRÜN KODU | 010 091 010004 |
| ÜRÜN ADI | 4'LÜ ETANJ BUTON KUTUSU EUROBOX |
| ADET/KOLİ | 10 |
| FİYAT (₺) | 168,70 |

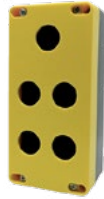

| | |
|-----------|---|
| ÜRÜN KODU | 010 104 000114 |
| ÜRÜN ADI | SW-BX05SB 5'Lİ ETANJ BUTON KUTUSU EUROBOX |
| ADET/KOLİ | 8 |
| FİYAT (₺) | 398,50 |



| | |
|-----------|---|
| ÜRÜN KODU | 010 104 000115 |
| ÜRÜN ADI | SW-BX06SB 6'Lİ ETANJ BUTON KUTUSU EUROBOX |
| ADET/KOLİ | 8 |
| FİYAT (₺) | 398,50 |



| | |
|-----------|---|
| ÜRÜN KODU | 010 104 000116 |
| ÜRÜN ADI | SW-BX07SB 7'Lİ ETANJ BUTON KUTUSU EUROBOX |
| ADET/KOLİ | 6 |
| FİYAT (₺) | 398,50 |



| | |
|-----------|---|
| ÜRÜN KODU | 010 104 000117 |
| ÜRÜN ADI | SW-BX08SB 8'Lİ ETANJ BUTON KUTUSU EUROBOX |
| ADET/KOLİ | 6 |
| FİYAT (₺) | 398,50 |



















| | |
|-----------|---|
| ÜRÜN KODU | 010 104 000118 |
| ÜRÜN ADI | SW-BX09SB 9'Lİ ETANJ BUTON KUTUSU EUROBOX |
| ADET/KOLİ | 1 |
| FİYAT (₺) | 662,20 |



| | |
|-----------|--|
| ÜRÜN KODU | 010 104 000119 |
| ÜRÜN ADI | SW-BX10SB 10'LU ETANJ BUTON KUTUSU EUROBOX |
| ADET/KOLİ | 1 |
| FİYAT (₺) | 662,20 |

ASANSÖR KUYU DİBİ SETLERİ VE KUMANDALARI

| | | | | | |
|---|---|---|--|---|--|
|  | <p>ÜRÜN KODU 010 104 000134</p> <p>ÜRÜN ADI MS-KYD02 2'LI ASANSÖR KUYU DİBİ BUTON 220V 16A TOP. PRİZ+ACİL STOP BUTON</p> <p>ADET/KOLİ 9</p> <p>FİYAT (₺) 403,80</p> |  | <p>ÜRÜN KODU 010 104 000135</p> <p>ÜRÜN ADI MS-KYD03 ACİL STOP BUTON + SEÇİCİ BUTON (2NO) 220V 16A TOP. PANO PRİZİ</p> <p>ADET/KOLİ 6</p> <p>FİYAT (₺) 613,60</p> |  | <p>ÜRÜN KODU 010 104 000136</p> <p>ÜRÜN ADI MS-KYD04 6'LI ACİL STOP BUT.+2 AD. OKLU BUT. (1NO) 1 İKİZ BUT. (2NO) 1 SEÇ.BUT. (2NO)</p> <p>ADET/KOLİ 5</p> <p>FİYAT (₺) 1.005,60</p> |
|  | <p>ÜRÜN KODU 010 104 000137</p> <p>ÜRÜN ADI MS-KYD05 ACİL STOP BUT.+ 2 OKLU BUT.ORTAK OKLU (1NO) SEÇ.BUT. (2NO-1NC)</p> <p>ADET/KOLİ 4</p> <p>FİYAT (₺) 926,40</p> |  | <p>ÜRÜN KODU 010 104 000138</p> <p>ÜRÜN ADI MS-KYD06 ACİL STOP BUT.+ 2 OKLU BUT.(2NO)1 ORTAK BUT.(1NO) ALARM BUT.+SEÇ.BUT. (2NO-1NC)</p> <p>ADET/KOLİ 2</p> <p>FİYAT (₺) 1.005,60</p> |  | <p>ÜRÜN KODU 010 104 000139</p> <p>ÜRÜN ADI KY2-ALR KORUMALI ACİL STOP BUT.(1NC) NO KONTAKLI ALARM BUTONU KOMBİNASYON</p> <p>ADET/KOLİ 10</p> <p>FİYAT (₺) 403,80</p> |
|  | <p>ÜRÜN KODU 010 104 000140</p> <p>ÜRÜN ADI MS-KY5-24 KOR.ACİL STOP BUT.(1NC) LAMB.VAVİEN (1NO)24V KATTA LED (1NO) ALARM BUT. 16A.KAP.PRİZ</p> <p>ADET/KOLİ 4</p> <p>FİYAT (₺) 1.053,10</p> |  | <p>ÜRÜN KODU 010 104 000141</p> <p>ÜRÜN ADI MS-KY3 KOR.ACİL STOP BUT.+ ALARM BUT.+16A KAPAKLI PRİZ KOMBİNASYON</p> <p>ADET/KOLİ 5</p> <p>FİYAT (₺) 585,90</p> |  | <p>ÜRÜN KODU 010 104 000142</p> <p>ÜRÜN ADI MS-KY3ES5012 KOR. ACİL STOP BUT. +ALARM+9V PİLLİ 130 dB KOMBİNASYON</p> <p>ADET/KOLİ 5</p> <p>FİYAT (₺) 950,20</p> |
|  | <p>ÜRÜN KODU 010 104 000143</p> <p>ÜRÜN ADI MS-KY4ES5012 KOR. ACİL STOP BUT. +9V PİLLİ 130 dB ALARM + 16A KAP. PRİZ KOMBİNASYON</p> <p>ADET/KOLİ 4</p> <p>FİYAT (₺) 1.053,10</p> |  | <p>ÜRÜN KODU 010 091 020001</p> <p>ÜRÜN ADI MS-LV4 YUKARI (1NO) AŞAĞI (1NO) 0-1 REVİZYON (1NO) ACİL STOP BUT. (1NC) EL TERMİNALİ (EL KUMANDA)</p> <p>ADET/KOLİ 6</p> <p>FİYAT (₺) 744,30</p> |  | <p>ÜRÜN KODU 010 104 000145</p> <p>ÜRÜN ADI MS-LV5 YUKARI (1NO) ORTAK (1NO) AŞAĞI (1NO) 0-1 REVİZYON (1NO) ACİL STOP BUT.(1NC) 16A KAP. PRİZ EL TERMİNALİ</p> <p>ADET/KOLİ 4</p> <p>FİYAT (₺) 1.053,10</p> |
|  | <p>ÜRÜN KODU 010 104 000146</p> <p>ÜRÜN ADI MS3BY-BG53P 3KD. BY-PASSLI LAMBA BUT.(1NO) 24V KATTA LEDLİ REG.AÇMA (1NO) 16A KAP.PRİZ KOMBİNASYON</p> <p>ADET/KOLİ 4</p> <p>FİYAT (₺) 1.441,10</p> |  | <p>ÜRÜN KODU 010 104 000147</p> <p>ÜRÜN ADI MS9-BX07 YUKARI (1NO)AŞAĞI (1NO) ORTAK(1NO) 24V KATTA LEDLİ KOR. ACİL STOP(1NC) ALR. (1NO)LAM.(1NO) KOR.0-1REV.(1NO)16A</p> <p>ADET/KOLİ 1</p> <p>FİYAT (₺) 1.551,90</p> |  | <p>ÜRÜN KODU 010 104 000148</p> <p>ÜRÜN ADI MS102-ED21 3BY 3KD.BYP REG.KİL. (1NO) REG.AÇ(1NO) 24V KATTA LED FREN AÇMA (1NO) KOR.0-1SET RESET (1NO)</p> <p>ADET/KOLİ 4</p> <p>FİYAT (₺) 1.599,40</p> |
|  | <p>ÜRÜN KODU 010 104 000149</p> <p>ÜRÜN ADI MS201-ED21 REG.AÇ KAPA (2NO)24V KATTA LED LAMBA BUT. (1NO) FREN AÇMA1 (1NO) FREN AÇMA2(1NO)KOR.SET RİSET (2NO)</p> <p>ADET/KOLİ 4</p> <p>FİYAT (₺) 1.068,90</p> | | | | |



010 104 000150



010 104 000151



010 104 000152

LİFT KUMANDA BUTONU - ÇİFT KONTAKLI

| Ürün Kodu | Ürün Adı | Koli Adet | Fiyat (₺) |
|----------------|--|-----------|-----------|
| 010 104 000150 | MLK-2 TEK HIZLI 2'Lİ LİFT KUMANDA - ÇİFT KONTAKLI -10A | 1 | 1.583,60 |
| 010 104 000151 | MLK-3 TEK HIZLI 3'LÜ LİFT KUMANDA - ÇİFT KONTAKLI -10A | 1 | 2.137,90 |
| 010 104 000152 | MLK-4 TEK HIZLI 4'LÜ LİFT KUMANDA - ÇİFT KONTAKLI -10A | 1 | 2.478,30 |



010 092 000001



010 092 000002



010 092 000003



010 092 000004



010 092 000005



010 092 000006

VİNÇ KUTULARI

| Ürün Kodu | Ürün Adı | Koli Adet | Fiyat (₺) |
|----------------|--------------------------------|-----------|-----------|
| 010 092 000001 | İKİLİ VİNÇ KUTUSU - TEK HIZLI | 1 | 1.063,60 |
| 010 092 000002 | ÜÇLÜ VİNÇ KUTUSU - TEK HIZLI | 1 | 1.213,00 |
| 010 092 000003 | DÖRTLÜ VİNÇ KUTUSU - TEK HIZLI | 1 | 1.371,20 |
| 010 092 000004 | BEŞLİ VİNÇ KUTUSU - TEK HIZLI | 1 | 1.523,60 |
| 010 092 000005 | ALTILI VİNÇ KUTUSU - TEK HIZLI | 1 | 1.857,60 |
| 010 092 000006 | YEDİLİ VİNÇ KUTUSU - TEK HIZLI | 1 | 2.010,00 |



010 104 000003



010 104 000004



010 104 000005



010 104 000006



010 104 000007



010 104 000008

SWISS SERİSİ PLASTİK YAYLI BUTONLAR

| Ürün Kodu | Ürün Adı | Koli Adet | Fiyat (₺) |
|----------------|---|-----------|-----------|
| 010 104 000003 | SW-AA42 22 mm PLASTİK YAYLI BUTON - STOP | 10 | 83,90 |
| 010 104 000004 | SW-AA31 22 mm PLASTİK YAYLI BUTON - START | 10 | 83,90 |
| 010 104 000005 | SW-AA51 22 mm PLASTİK YAYLI BUTON - START | 10 | 83,90 |
| 010 104 000006 | SW-AA61 22 mm PLASTİK YAYLI BUTON - START | 10 | 83,90 |
| 010 104 000007 | SW-AA21 22 mm PLASTİK YAYLI BUTON - START | 10 | 83,90 |
| 010 104 000008 | SW-AA11 22 mm PLASTİK YAYLI BUTON - START | 10 | 83,90 |

SWISS SERİSİ PLASTİK KALICI BUTONLAR

| Ürün Kodu | Ürün Adı | Koli Adet | Fiyat (₺) |
|----------------|---|-----------|-----------|
| 010 104 000195 | SW-K42 22MM PLASTİK KALICI BUTON STOP (YENİ ÜRÜN) | 10 | 158,40 |
| 010 104 000196 | SW-K31 22MM PLASTİK KALICI BUTON START (YENİ ÜRÜN) | 10 | 158,40 |
| 010 104 000197 | SW-K51 22MM PLASTİK KALICI BUTON START (YENİ ÜRÜN) | 10 | 158,40 |
| 010 104 000198 | SW-K61 22MM PLASTİK KALICI BUTON START (YENİ ÜRÜN) | 10 | 158,40 |
| 010 104 000199 | SW-KA21 22MM PLASTİK KALICI BUTON START (YENİ ÜRÜN) | 10 | 158,40 |
| 010 104 000200 | SW-KA11 22MM PLASTİK KALICI BUTON START (YENİ ÜRÜN) | 10 | 158,40 |



010 104 00009



010 104 00010



010 104 00011



010 104 00012



010 104 00013



010 104 00014

SWISS SERİSİ PLASTİK YAYLI BUTONLAR

| Ürün Kodu | Ürün Adı | Koli Adet | Fiyat (₺) |
|---------------|---|-----------|-----------|
| 010 104 00009 | SW-AA4322 22 mm PLASTİK YAYLI BUTON - STOP | 10 | 88,20 |
| 010 104 00010 | SW-AA3361 22 mm PLASTİK YAYLI BUTON - START | 10 | 88,20 |
| 010 104 00011 | SW-AA3351 22 mm PLASTİK YAYLI BUTON - START | 10 | 88,20 |
| 010 104 00012 | SW-AA3341 22 mm PLASTİK YAYLI BUTON - START | 10 | 88,20 |
| 010 104 00013 | SW-AA3371 22 mm PLASTİK YAYLI BUTON - START | 10 | 88,20 |
| 010 104 00014 | SW-AA3381 22 mm PLASTİK YAYLI BUTON - START | 10 | 88,20 |



010 104 00015



010 104 00016



010 104 00017



010 104 00018



010 104 00019



010 104 00020



010 104 00021



010 104 00022



010 104 00023



010 104 00024

SWISS SERİSİ PLASTİK YAYLI İKİZ BUTONLAR

| Ürün Kodu | Ürün Adı | Koli Adet | Fiyat (₺) |
|---------------|---|-----------|-----------|
| 010 104 00015 | SW-AL7325 22 mm PLASTİK İKİZ BUTON (1NO+1NC) | 10 | 172,20 |
| 010 104 00016 | SW-AL7181 22 mm PLASTİK ALARM - LAMBA İKİZ BUTON (1NO+1NO) | 10 | 189,60 |
| 010 104 00017 | SW-AL4252 22 mm PLASTİK YUKARI AŞAĞI OKLU TERS YÖNLÜ İKİZ BUTON (1NO+1NO) | 10 | 189,60 |
| 010 104 00018 | SW-AL6171 22 mm PLASTİK ALARM ORTAK OKLU İKİZ BUTON (1NO+1NO) | 10 | 189,60 |
| 010 104 00019 | SW-AL6181 22 mm PLASTİK LAMBA ORTAK OKLU İKİZ BUTON (1NO+1NO) | 10 | 189,60 |
| 010 104 00020 | SW-AL7425 22 mm PLASTİK İŞARETLİ İKİZ BUTON (1NO+1NC) | 10 | 189,60 |
| 010 104 00021 | SW-AL7525 22 mm PLASTİK YAZILI İKİZ BUTON (1NO+1NC) | 10 | 189,60 |
| 010 104 00022 | SW-AL4151 22 mm PLASTİK YUKARI AŞAĞI OKLU BUTON (1NO+1NO) | 10 | 189,60 |
| 010 104 00023 | SW-AL7465L 22 mm PLASTİK İKİZ BUTON (1NO+1NC) LEDLİ 220V AC/DC | 10 | 318,80 |
| 010 104 00024 | SW-AL7465-24L 22 mm PLASTİK İKİZ BUTON (1NO+1NC) LEDLİ 24V AC/DC | 10 | 318,80 |



010 104 000025



010 104 000026



010 104 000027



010 104 000028

SWISS SERİSİ PLASTİK KALICI VE KAYICI MANDAL BUTONLAR

| Ürün Kodu | Ürün Adı | Koli Adet | Fiyat (₺) |
|----------------|---|-----------|-----------|
| 010 104 000025 | SW-AD21 PLASTİK KALICI 0 - 1 MANDAL BUTON (1NO) | 10 | 99,00 |
| 010 104 000026 | SW-AD41 PLASTİK KAYICI 0 - 1 MANDAL BUTON (1NO) | 10 | 112,20 |
| 010 104 000027 | SW-AD33 PLASTİK KALICI 2 - 0 - 1 MANDAL BUTON (1NO+1NO) | 10 | 144,00 |
| 010 104 000028 | SW-AD53 PLASTİK KAYICI 2 - 0 - 1 MANDAL BUTON (1NO+1NO) | 10 | 156,00 |



010 104 000029



010 104 000030



010 104 000031



010 104 000032

SWISS SERİSİ PLASTİK ANAHTARLI KALICI VE KAYICI MANDAL BUTONLAR

| Ürün Kodu | Ürün Adı | Koli Adet | Fiyat (₺) |
|----------------|---|-----------|-----------|
| 010 104 000029 | SW-AG21 PLASTİK KALICI 0 - 1 ANAHTARLI MANDAL BUTON (1NO) | 10 | 262,70 |
| 010 104 000030 | SW-AG41 PLASTİK KAYICI 0 - 1 ANAHTARLI MANDAL BUTON (1NO) | 10 | 262,70 |
| 010 104 000031 | SW-AG33 PLASTİK KALICI 2 - 0 - 1 ANAHTARLI MANDAL BUTON (1NO+1NO) | 10 | 308,90 |
| 010 104 000032 | SW-AG53 PLASTİK KAYICI 2 - 0 - 1 ANAHTARLI MANDAL BUTON (1NO+1NO) | 10 | 308,90 |



010 104 000037



010 104 000038



010 104 000039

SWISS SERİSİ PLASTİK KAYICI MANTAR BUTONLAR

| Ürün Kodu | Ürün Adı | Koli Adet | Fiyat (₺) |
|----------------|---|-----------|-----------|
| 010 104 000037 | SW-AC42 40MM KAFA PLASTİK KAYICI MANTAR BUTON (1NC) | 10 | 134,40 |
| 010 104 000038 | SW-AC31 40MM KAFA PLASTİK KAYICI MANTAR BUTON (1NO) | 10 | 134,40 |
| 010 104 000039 | SW-AC51 40MM KAFA PLASTİK KAYICI MANTAR BUTON (1NO) | 10 | 134,40 |



010 104 000033



010 104 000034



010 104 000035



010 104 000036

SWISS SERİSİ PLASTİK MANTAR ACİL STOP BUTONLAR

| Ürün Kodu | Ürün Adı | Koli Adet | Fiyat (₺) |
|----------------|--|-----------|-----------|
| 010 104 000033 | SW-AS142 40 mm KAFA PLASTİK ANAHTARLI MANTAR BUTON (1NC) ACİL STOP | 10 | 299,90 |
| 010 104 000034 | SW-AS42E 40 mm KAFA PLASTİK MANTAR BUTON (1NC) ACİL STOP ETİKETLİ | 10 | 150,00 |
| 010 104 000035 | SW-AS542 40 mm KAFA PLASTİK MANTAR BUTON (1NC) ACİL STOP | 10 | 126,00 |
| 010 104 000036 | SW-AS442 30 mm KAFA PLASTİK MANTAR BUTON (1NC) ACİL STOP | 10 | 134,40 |



010 104 000040



010 104 000041



010 104 000042



010 104 000043



010 104 000044



010 104 000045



010 104 000046



010 104 000047

SWISS SERİSİ PLASTİK LEDLİ, IŞIKLI, YAYLI BUTONLAR

| Ürün Kodu | Ürün Adı | Koli Adet | Fiyat (₺) |
|----------------|---|-----------|-----------|
| 010 104 000040 | SW-AW3475 22 mm LEDLİ IŞIKLI YAYLI BUTON STOP - 110-240V AC | 10 | 245,90 |
| 010 104 000041 | SW-AW3475 22 mm LEDLİ IŞIKLI YAYLI BUTON STOP - 10-30V DC | 10 | 245,90 |
| 010 104 000042 | SW-AW3375 22 mm LEDLİ IŞIKLI YAYLI BUTON START - 110-240V AC | 10 | 245,90 |
| 010 104 000043 | SW-AW3375-24 22 mm LEDLİ IŞIKLI YAYLI BUTON START - 10-30V DC | 10 | 245,90 |
| 010 104 000044 | SW-AW3575 22 mm LEDLİ IŞIKLI YAYLI BUTON START - 110-240V AC | 10 | 245,90 |
| 010 104 000045 | SW-AW3575-24 22 mm LEDLİ IŞIKLI YAYLI BUTON START - 10-30V DC | 10 | 245,90 |
| 010 104 000046 | SW-AW3675 22 mm LEDLİ IŞIKLI YAYLI BUTON START - 110-240V AC | 10 | 245,90 |
| 010 104 000047 | SW-AW3675-24 22 mm LEDLİ IŞIKLI YAYLI BUTON START - 10-30V DC | 10 | 245,90 |



010 104 000001



010 104 000002

POTANSİYOMETRE

| Ürün Kodu | Ürün Adı | Koli Adet | Fiyat (₺) |
|----------------|---------------------|-----------|-----------|
| 010 104 000001 | MS22-5K POTANS 5K | 15 | 421,70 |
| 010 104 000002 | MS22-10K POTANS 10K | 15 | 421,70 |



010 104 000054



010 104 000055



010 104 000056



010 104 000057



010 104 000058



010 104 000059

SWISS SERİSİ 1-0-2 PLASTİK LEDLİ, IŞIKLI KALICI MANDAL BUTONLAR

| Ürün Kodu | Ürün Adı | Koli Adet | Fiyat (₺) |
|----------------|---|-----------|-----------|
| 010 104 000054 | SW-AK323L 1-0-2 PLASTİK LEDLİ KALICI MANDAL BUTON (2NO) 110-240V AC | 10 | 308,00 |
| 010 104 000055 | SW-AK324L 1-0-2 PLASTİK LEDLİ KALICI MANDAL BUTON (2NC) 110-240V AC | 10 | 308,00 |
| 010 104 000056 | SW-AK325L 1-0-2 PLASTİK LEDLİ KALICI MANDAL BUTON (2NO) 110-240V AC | 10 | 308,00 |
| 010 104 000057 | SW-AK323-24L 1-0-2 PLASTİK LEDLİ KALICI MANDAL BUTON (2NO) 10-24V AC/DC | 10 | 308,00 |
| 010 104 000058 | SW-AK324-24L 1-0-2 PLASTİK LEDLİ KALICI MANDAL BUTON (2NC) 10-24V AC/DC | 10 | 308,00 |
| 010 104 000059 | SW-AK325-24L 1-0-2 PLASTİK LEDLİ KALICI MANDAL BUTON (2NO) 10-24V AC/DC | 10 | 308,00 |



010 104 000048



010 104 000049



010 104 000050



010 104 000051



010 104 000052



010 104 000053

SWISS SERİSİ 0-1 PLASTİK LEDLİ, IŞIKLI KALICI MANDAL BUTONLAR

| Ürün Kodu | Ürün Adı | Koli Adet | Fiyat (₺) |
|----------------|---|-----------|-----------|
| 010 104 000048 | SW-AK123L 0-1 PLASTİK LEDLİ KALICI MANDAL BUTON (1NO) 110-240V AC | 10 | 260,90 |
| 010 104 000049 | SW-AK124L 0-1 PLASTİK LEDLİ KALICI MANDAL BUTON (1NC) 110-240V AC | 10 | 260,90 |
| 010 104 000050 | SW-AK125L 0-1 PLASTİK LEDLİ KALICI MANDAL BUTON (1NO) 110-240V AC | 10 | 260,90 |
| 010 104 000051 | SW-AK123-24L 0-1 PLASTİK LEDLİ KALICI MANDAL BUTON (1NO) 10-24V AC/DC | 10 | 260,90 |
| 010 104 000052 | SW-AK124-24L 0-1 PLASTİK LEDLİ KALICI MANDAL BUTON (1NC) 10-24V AC/DC | 10 | 260,90 |
| 010 104 000053 | SW-AK125-24L 0-1 PLASTİK LEDLİ KALICI MANDAL BUTON (1NO) 10-24V AC/DC | 10 | 260,90 |



010 104 000064

010 104 000065

010 104 000066

010 104 000067

010 104 000068

010 104 000069

SWISS SERİSİ METAL KAPLAMALI YAYLI BUTONLAR

| Ürün Kodu | Ürün Adı | Koli Adet | Fiyat (₺) |
|----------------|---------------------------------------|-----------|-----------|
| 010 104 000064 | SW-BA42 22 mm YAYLI BUTON STOP (1NC) | 10 | 93,00 |
| 010 104 000065 | SW-BA31 22 mm YAYLI BUTON START (1NO) | 10 | 93,00 |
| 010 104 000066 | SW-BA51 22 mm YAYLI BUTON START (1NO) | 10 | 93,00 |
| 010 104 000067 | SW-BA11 22 mm YAYLI BUTON START (1NO) | 10 | 93,00 |
| 010 104 000068 | SW-BA61 22 mm YAYLI BUTON START (1NO) | 10 | 93,00 |
| 010 104 000069 | SW-BA21 22 mm YAYLI BUTON START (1NO) | 10 | 93,00 |

SWISS SERİSİ METAL KAPLAMALI KALICI BUTONLAR

| Ürün Kodu | Ürün Adı | Koli Adet | Fiyat (₺) |
|----------------|---|-----------|-----------|
| 010 104 000201 | SW-BK42 22 MM YAYLI KALICI BUTON STOP (1NC) (YENİ ÜRÜN) | 10 | 170,40 |
| 010 104 000202 | SW-BK31 22 MM YAYLI KALICI BUTON START (1NC) (YENİ ÜRÜN) | 10 | 170,40 |
| 010 104 000203 | SW-BK51 22 MM YAYLI KALICI BUTON START (1NC) (YENİ ÜRÜN) | 10 | 170,40 |
| 010 104 000204 | SW-BK11 22 MM YAYLI KALICI BUTON START (1NC) (YENİ ÜRÜN) | 10 | 170,40 |
| 010 104 000205 | SW-BK61 22 MM YAYLI KALICI BUTON START (1NC) (YENİ ÜRÜN) | 10 | 170,40 |
| 010 104 000206 | SW-BK21 22 MM YAYLI KALICI BUTON START (1NC) (YENİ ÜRÜN) | 10 | 170,40 |



010 104 000071

010 104 000072

010 104 000073

010 104 000074

010 104 000075

010 104 000076

SWISS SERİSİ METAL KAPLAMALI İŞARETLİ YAYLI BUTONLAR

| Ürün Kodu | Ürün Adı | Koli Adet | Fiyat (₺) |
|----------------|--|-----------|-----------|
| 010 104 000071 | SW-BA4322 22 mm İŞARETLİ YAYLI BUTON STOP (1NC) | 10 | 101,30 |
| 010 104 000072 | SW-BA3351 22 mm İŞARETLİ YAYLI BUTON START (1NO) | 10 | 101,30 |
| 010 104 000073 | SW-BA3341 22 mm İŞARETLİ YAYLI BUTON START (1NO) | 10 | 101,30 |
| 010 104 000074 | SW-BA3361 22 mm İŞARETLİ YAYLI BUTON START (1NO) | 10 | 101,30 |
| 010 104 000075 | SW-BA3371 22 mm İŞARETLİ YAYLI BUTON START (1NO) | 10 | 101,30 |
| 010 104 000076 | SW-BA3381 22 mm İŞARETLİ YAYLI BUTON START (1NO) | 10 | 101,30 |



010 104 000077

010 104 000078

010 104 000079

SWISS SERİSİ METAL KAPLAMALI İKİZ BUTONLAR

| Ürün Kodu | Ürün Adı | Koli Adet | Fiyat (₺) |
|----------------|---|-----------|-----------|
| 010 104 000077 | SW-BL7325 22 mm PLASTİK İKİZ BUTON (1NO+1NC) | 10 | 189,00 |
| 010 104 000078 | SW-BL7425 22 mm PLASTİK İKİZ BUTON (1NO+1NC) | 10 | 209,00 |
| 010 104 000079 | SW-BL7525 22 mm PLASTİK YAZILI İKİZ BUTON (1NO+1NC) | 10 | 209,00 |



010 104 000080

010 104 000081

010 104 000082

010 104 000083

010 104 000084

010 104 000085

010 104 000086

SWISS SERİSİ METAL KAPLAMALI İKİZ BUTONLAR

| Ürün Kodu | Ürün Adı | Koli Adet | Fiyat (₺) |
|----------------|---|-----------|-----------|
| 010 104 000080 | SW-BL4151 22 mm PLASTİK YUKARI AŞAĞI OKLU İKİZ BUTON (1NO+1NO) | 10 | 209,00 |
| 010 104 000081 | SW-BL4252 22 mm PLASTİK YUKARI AŞAĞI TERS YÖN OKLU İKİZ BUTON (1NO+1NO) | 10 | 209,00 |
| 010 104 000082 | SW-BL6171 22 mm PLASTİK ALARM ORTAK OKLU İKİZ BUTON (1NO+1NO) | 10 | 209,00 |
| 010 104 000083 | SW-BL7181 22 mm PLASTİK ALARM - LAMBA İKİZ BUTON (1NO+1NO) | 10 | 209,00 |
| 010 104 000084 | SW-BL6181 22 mm PLASTİK LAMBA ORTAK OKLU İKİZ BUTON (1NO+1NO) | 10 | 209,00 |
| 010 104 000085 | SW-BL7465L 22 mm PLASTİK İKİZ BUTON LEDLİ (220V AC) | 10 | 350,90 |
| 010 104 000086 | SW-BL7465L-24L 22 mm PLASTİK İKİZ BUTON LEDLİ (24V AC/DC) | 10 | 350,90 |



010 104 000087



010 104 000088



010 104 000089



010 104 000090

SWISS SERİSİ METAL KAPLAMALI KALICI VE KAYICI MANDAL BUTONLAR

| Ürün Kodu | Ürün Adı | Koli Adet | Fiyat (₺) |
|----------------|---|-----------|-----------|
| 010 104 000087 | SW-BD21 0-1 KALICI MANDAL BUTON (1NO) | 10 | 108,90 |
| 010 104 000088 | SW-BD41 0-1 KAYICI MANDAL BUTON (1NO) | 10 | 123,00 |
| 010 104 000089 | SW-BD33 1-0-2 KALICI MANDAL BUTON (1NO+1NO) | 10 | 159,00 |
| 010 104 000090 | SW-BD53 1-0-2 KAYICI MANDAL BUTON (1NO+1NO) | 10 | 174,00 |



010 104 000168



010 104 000169



010 104 000170



010 104 000171



010 104 000172



010 104 000173

SWISS SERİSİ METAL KAPLAMALI 0-1 LEDLİ KALICI BUTONLAR

| Ürün Kodu | Ürün Adı | Koli Adet | Fiyat (₺) |
|----------------|---|-----------|-----------|
| 010 104 000168 | SW-BK123L 0-1 LEDLİ İŞIKLI KALICI MANDAL BUTON (1NO) 110-240V AC | 10 | 269,30 |
| 010 104 000169 | SW-BK124L 0-1 LEDLİ İŞIKLI KALICI MANDAL BUTON (1NC) 110-240V AC | 10 | 269,30 |
| 010 104 000170 | SW-BK125L 0-1 LEDLİ İŞIKLI KALICI MANDAL BUTON (1NO) 110-240V AC | 10 | 269,30 |
| 010 104 000171 | SW-BK123L-24L 0-1 LEDLİ İŞIKLI KALICI MANDAL BUTON (1NO) 10-30V AC/DC | 10 | 269,30 |
| 010 104 000172 | SW-BK124L-24L 0-1 LEDLİ İŞIKLI KALICI MANDAL BUTON (1NC) 10-30V AC/DC | 10 | 269,30 |
| 010 104 000173 | SW-BK125L-24L 0-1 LEDLİ İŞIKLI KALICI MANDAL BUTON (1NC) 10-30V AC/DC | 10 | 269,30 |



010 104 000160



010 104 000162



010 104 000164



010 104 000166



010 104 000161



010 104 000163



010 104 000165



010 104 000167

SWISS SERİSİ METAL KAPLAMALI LEDLİ İŞIKLI YAYLI BUTONLAR

| Ürün Kodu | Ürün Adı | Koli Adet | Fiyat (₺) |
|----------------|---|-----------|-----------|
| 010 104 000160 | BW-3475 22 mm LEDLİ İŞIKLI YAYLI BUTON STOP 110-240V AC | 10 | 251,90 |
| 010 104 000161 | BW-3475-24L 22 mm LEDLİ İŞIKLI YAYLI BUTON STOP 10-30V AC/DC | 10 | 251,90 |
| 010 104 000162 | BW-3375 22 mm LEDLİ İŞIKLI YAYLI BUTON START 110-240V AC | 10 | 251,90 |
| 010 104 000163 | BW-3375-24L 22 mm LEDLİ İŞIKLI YAYLI BUTON START 10-30V AC/DC | 10 | 251,90 |
| 010 104 000164 | BW-3575 22 mm LEDLİ İŞIKLI YAYLI BUTON START 110-240V AC | 10 | 251,90 |
| 010 104 000165 | BW-3575-24L 22 mm LEDLİ İŞIKLI YAYLI BUTON START 10-30V AC/DC | 10 | 251,90 |
| 010 104 000166 | BW-3675 22 mm LEDLİ İŞIKLI YAYLI BUTON START 110-240V AC | 10 | 251,90 |
| 010 104 000167 | BW-3675-24L 22 mm LEDLİ İŞIKLI YAYLI BUTON START 10-30V AC/DC | 10 | 251,90 |



010 104 000174



010 104 000175



010 104 000176



010 104 000177



010 104 000178



010 104 000179

SWISS SERİSİ METAL KAPLAMALI 0-1-2 LEDLİ KALICI MANDAL BUTONLAR

| Ürün Kodu | Ürün Adı | Koli Adet | Fiyat (₺) |
|----------------|---|-----------|-----------|
| 010 104 000174 | BK-323L 1-0-2 PLASTİK LEDLİ KALICI MANDAL BUTON (2NO) 110-240V AC | 10 | 314,30 |
| 010 104 000175 | BK-324L 1-0-2 PLASTİK LEDLİ KALICI MANDAL BUTON (2NC) 110-240V AC | 10 | 314,30 |
| 010 104 000176 | BK-325L 1-0-2 PLASTİK LEDLİ KALICI MANDAL BUTON (2NO) 110-240V AC | 10 | 314,30 |
| 010 104 000177 | BK-323-24L 1-0-2 PLASTİK LEDLİ KALICI MANDAL BUTON (2NO) 10-24V AC/DC | 10 | 314,30 |
| 010 104 000178 | BK-324-24L 1-0-2 PLASTİK LEDLİ KALICI MANDAL BUTON (2NC) 10-24V AC/DC | 10 | 314,30 |
| 010 104 000179 | BK-325-24L 1-0-2 PLASTİK LEDLİ KALICI MANDAL BUTON (2NO) 10-24V AC/DC | 10 | 314,30 |



010 104 000060



010 104 000061



010 104 000062

YAYLI BUTON YEDEK KONTAKLARI VE KILIFI

| Ürün Kodu | Ürün Adı | Koli Adet | Fiyat (₺) |
|----------------|--|-----------|-----------|
| 010 104 000060 | SW-BE101 KONTAK BLOK (NO) | 50 | 46,80 |
| 010 104 000061 | SW-BE102 KONTAK BLOK (NC) | 50 | 46,80 |
| 010 104 000062 | SW-BE103 İŞIK SOKETİ 10/30 110-240V AC | 50 | 162,00 |



010 104 000091



010 104 000092



010 104 000093



010 093 000002



010 093 000001



010 093 000099

BUTON AKSESUARLARI

| Ürün Kodu | Ürün Adı | Koli Adet | Fiyat (₺) |
|----------------|--|-----------|-----------|
| 010 104 000091 | SW-BR1 PLASTİK BUTON ROZETİ 26x8 CAMLI | 100 | 31,80 |
| 010 104 000092 | SW-BR2 PLASTİK BUTON ROZETİ 26x18 CAMLI | 100 | 36,00 |
| 010 104 000093 | SW-SİE-R PLASTİK BUTON ROZETİ 27x12 CAMSIZ | 100 | 28,20 |
| 010 093 000002 | SW-BRY PLASTİK YAZILI BUTON ROZETİ | 100 | 17,40 |
| 010 093 000001 | SW-AP2 BUTON KORUMA KILIFI (YAYLI BUTONLAR İÇİN) | 50 | 39,60 |
| 010 104 000099 | SW-AP4 IP67 İKİZ BUTON KORUMA KILIFI (YAYLI BUTONLAR İÇİN) | 50 | 39,60 |



010 104 000095



010 104 000096



010 093 000003



010 090 050008



010 104 000101



010 104 000102



010 104 000104

ACİL STOP ETİKETLERİ

| Ürün Kodu | Ürün Adı | Koli Adet | Fiyat (₺) |
|----------------|---|-----------|-----------|
| 010 104 000095 | SW-ER60TE Ø60 mm PLASTİK ACİL DURDURMA + EMERGENCY ROZETİ (KALIN TİP) LAZER BASKI | 50 | 39,60 |
| 010 104 000096 | SW-ER60EN-Y Ø60 mm PLASTİK EMERGENCY ROZETİ (İNCE TİP) LAZER BASKI | 50 | 30,00 |
| 010 093 000003 | ACİL DURDURMA ETİKETİ | 50 | 28,20 |
| 010 090 050008 | SW-AKKM EMNİYET BASMA DÜĞMESİ MUHAFAZA | 50 | 23,80 |
| 010 104 000101 | SW-AKK ACİL STOP KORUMA KAPAĞI | 50 | 55,40 |
| 010 104 000102 | SW-AKKY ACİL STOP KORUMA KAPAĞI | 50 | 57,00 |
| 010 104 000104 | SW-MKKY MANDAL BUTON KORUMA KAPAĞI | 50 | 55,40 |



999 999 995000



999 999 995001



999 999 995002

VOLTMETRE VE AMPERMETRE

| Ürün Kodu | Ürün Adı | Koli Adet | Fiyat (₺) |
|----------------|--|-----------|-----------|
| 999 999 995000 | 22 mm VOLTMETRE PLASTİK LED GÖSTERGELİ 20-500V AC | 10 | 293,90 |
| 999 999 995001 | 22 mm AMPERMETRE (AKIM TRAFOLU) PLS. LED GÖS. 1A-100A AC / 60-380V AC | 10 | 586,00 |
| 999 999 995002 | 22 mm VOLT + AMPERMETRE (AKIM TRAFOLU) PLS. LED GÖS. 12-500V AC / 1A-100A AC | 10 | 736,60 |



010 090 010001



010 090 010005



010 090 010006



010 090 010007



010 090 010008



010 090 010009



010 090 010010

MUTLUSAN SİNYAL VE KUMANDA BUTONLARI

| Ürün Kodu | Ürün Adı | Koli Adet | Fiyat (₺) |
|----------------|-------------------------------|-----------|-----------|
| 010 090 010001 | 10 mm KABLOLU SİNYAL ARMATÜRÜ | 100 | 20,70 |
| 010 090 010005 | 14 mm SİNYAL ARMATÜRÜ - 12V | 50 | 32,40 |
| 010 090 010006 | 14 mm SİNYAL ARMATÜRÜ - 24V | 50 | 32,40 |
| 010 090 010007 | 14 mm SİNYAL ARMATÜRÜ - 220V | 50 | 32,40 |
| 010 090 010008 | 22 mm SİNYAL ARMATÜRÜ - 12V | 24 | 36,60 |
| 010 090 010009 | 22 mm SİNYAL ARMATÜRÜ - 24V | 24 | 36,60 |
| 010 090 010010 | 22 mm SİNYAL ARMATÜRÜ - 220V | 24 | 36,60 |



010 090 010004



010 090 070002



010 111 070001



010 111 070002



010 111 070003



010 111 070004

MUTLUSAN SİNYAL VE KUMANDA BUTONLARI

| Ürün Kodu | Ürün Adı | Koli Adet | Fiyat (₺) |
|----------------|--------------------------------|-----------|-----------|
| 010 090 010004 | 22 mm SİNYAL ARM. LEDLİ - 220V | 24 | 49,50 |
| 010 090 070002 | 22 mm SİNYAL ARM. LEDLİ - 24V | 24 | 47,50 |
| 010 111 070001 | BUZZER LEDLİ - 220V | 24 | 213,80 |
| 010 111 070002 | BUZZER LEDLİ - 24V | 24 | 213,80 |
| 010 111 070003 | BUZZER - 220V | 24 | 178,20 |
| 010 111 070004 | BUZZER LEDLİ - 24V | 24 | 178,20 |



MB-QH

MB-BH..1

MB-BH..2

MB-BH..3

T5
Ø50



T7
Ø70



multi



T6

BORULU KORNALAR, IŞIKLI KOLONLAR, İKAZ LAMBALARI

| Ürün Kodu | Çap (Ø) | Ürün Adı | Çalışma Şekli | Besleme Gerilimi | Adet | Fiyat (\$) |
|-----------|---------|----------|---------------|------------------|------|------------|
|-----------|---------|----------|---------------|------------------|------|------------|

BH SERİSİ MULTİ 105 dB 1-2-3 KATLI BORULU KORNALAR

| | | | | | | |
|----------------|--|----------|-------|---------|---|-----------|
| 129 087 000401 | | M-BH-241 | MULTİ | 24 V DC | 1 | 66,40 \$ |
| 129 087 000403 | | M-BH-221 | MULTİ | 220V AC | 1 | 74,70 \$ |
| 129 087 000405 | | M-BH-242 | MULTİ | 24 V DC | 1 | 99,60 \$ |
| 129 087 000407 | | M-BH-222 | MULTİ | 220V AC | 1 | 116,20 \$ |
| 129 087 000409 | | M-BH-243 | MULTİ | 24 V DC | 1 | 116,20 \$ |
| 129 087 000411 | | M-BH-223 | MULTİ | 220V AC | 1 | 132,80 \$ |

QH SERİSİ MULTİ 105 dB 1-2-3 KATLI BORULU KORNALAR

| | | | | | | |
|----------------|--|----------|-------|---------|---|-----------|
| 129 087 000400 | | M-QH-241 | MULTİ | 24 V DC | 1 | 66,40 \$ |
| 129 087 000402 | | M-QH-221 | MULTİ | 220V AC | 1 | 74,70 \$ |
| 129 087 000404 | | M-QH-242 | MULTİ | 24 V DC | 1 | 99,60 \$ |
| 129 087 000406 | | M-QH-222 | MULTİ | 220V AC | 1 | 116,20 \$ |
| 129 087 000408 | | M-QH-243 | MULTİ | 24 V DC | 1 | 116,20 \$ |
| 129 087 000410 | | M-QH-223 | MULTİ | 220V AC | 1 | 132,80 \$ |

| Ürün Kodu | Ürün Adı | Çalışma Şekli | Besleme Gerilimi | Adet | Fiyat (\$) |
|-----------|----------|---------------|------------------|------|------------|
|-----------|----------|---------------|------------------|------|------------|

T5 SERİSİ 1 KATLI IŞIKLI KOLONLAR

| | | | | | |
|----------------|-----------|-----------------|---------|---|----------|
| 129 087 000278 | S-T5-241 | SABİT | 24 V DC | 1 | 41,50 \$ |
| 129 087 000279 | S-T5-221 | SABİT | 220V AC | 1 | 49,80 \$ |
| 129 087 000281 | F-T5-241 | FLAŞÖRLÜ | 24V DC | 1 | 64,80 \$ |
| 129 087 000282 | F-T5-221 | FLAŞÖRLÜ | 220V AC | 1 | 69,70 \$ |
| 129 087 000284 | Ç-T5-241 | ÇAKAR | 24 V DC | 1 | 64,80 \$ |
| 129 087 000285 | Ç-T5-221 | ÇAKAR | 220V AC | 1 | 69,70 \$ |
| 129 087 000287 | SB-T5-241 | SABİT+BUZZER | 24V DC | 1 | 68,10 \$ |
| 129 087 000288 | SB-T5-221 | SABİT+BUZZER | 220V AC | 1 | 76,40 \$ |
| 129 087 000290 | FB-T5-241 | FLAŞÖRLÜ+BUZZER | 24V DC | 1 | 81,40 \$ |
| 129 087 000291 | FB-T5-221 | FLAŞÖRLÜ+BUZZER | 220V AC | 1 | 89,70 \$ |

T5 SERİSİ 2 KATLI IŞIKLI KOLONLAR

| | | | | | |
|----------------|-----------|-----------------|---------|---|----------|
| 129 087 000296 | S-T5-242 | SABİT | 24 V DC | 1 | 59,80 \$ |
| 129 087 000297 | S-T5-222 | SABİT | 220V AC | 1 | 63,10 \$ |
| 129 087 000299 | F-T5-242 | FLAŞÖRLÜ | 24V DC | 1 | 71,40 \$ |
| 129 087 000300 | F-T5-222 | FLAŞÖRLÜ | 220V AC | 1 | 84,70 \$ |
| 129 087 000302 | SB-T5-242 | SABİT+BUZZER | 24 V DC | 1 | 78,00 \$ |
| 129 087 000303 | SB-T5-222 | SABİT+BUZZER | 220V AC | 1 | 86,30 \$ |
| 129 087 000305 | FB-T5-242 | FLAŞÖRLÜ+BUZZER | 24V DC | 1 | 88,00 \$ |
| 129 087 000306 | FB-T5-222 | FLAŞÖRLÜ+BUZZER | 220V AC | 1 | 96,30 \$ |

T5 SERİSİ 3 KATLI IŞIKLI KOLONLAR

| | | | | | |
|----------------|-----------|-----------------|---------|---|-----------|
| 129 087 000308 | S-T5-243 | SABİT | 24 V DC | 1 | 63,10 \$ |
| 129 087 000309 | S-T5-223 | SABİT | 220V AC | 1 | 68,10 \$ |
| 129 087 000311 | F-T5-243 | FLAŞÖRLÜ | 24V DC | 1 | 81,40 \$ |
| 129 087 000312 | F-T5-223 | FLAŞÖRLÜ | 220V AC | 1 | 89,70 \$ |
| 129 087 000314 | SB-T5-243 | SABİT+BUZZER | 24 V DC | 1 | 98,00 \$ |
| 129 087 000315 | SB-T5-223 | SABİT+BUZZER | 220V AC | 1 | 106,30 \$ |
| 129 087 000317 | FB-T5-243 | FLAŞÖRLÜ+BUZZER | 24V DC | 1 | 106,30 \$ |
| 129 087 000318 | FB-T5-223 | FLAŞÖRLÜ+BUZZER | 220V AC | 1 | 116,20 \$ |

T7 SERİSİ 1 KATLI IŞIKLI KOLONLAR

| | | | | | |
|----------------|-----------|----------------|---------|---|----------|
| 129 087 000651 | M-T7-241 | MULTİ | 24 V DC | 1 | 41,50 \$ |
| 129 087 000652 | M-T7-221 | MULTİ | 220V AC | 1 | 49,90 \$ |
| 129 087 000653 | MB-T7-241 | MULTİ + BUZZER | 24V DC | 1 | 49,80 \$ |
| 129 087 000654 | MB-T7-221 | MULTİ + BUZZER | 220V AC | 1 | 58,10 \$ |

T7 SERİSİ 2 KATLI IŞIKLI KOLONLAR

| | | | | | |
|----------------|-----------|----------------|---------|---|----------|
| 129 087 000655 | M-T7-242 | MULTİ | 24 V DC | 1 | 56,50 \$ |
| 129 087 000656 | M-T7-222 | MULTİ | 220V AC | 1 | 66,50 \$ |
| 129 087 000657 | MB-T7-242 | MULTİ + BUZZER | 24V DC | 1 | 66,40 \$ |
| 129 087 000658 | MB-T7-222 | MULTİ + BUZZER | 220V AC | 1 | 74,70 \$ |

T7 SERİSİ 3 KATLI IŞIKLI KOLONLAR

| | | | | | |
|----------------|-----------|----------------|---------|---|----------|
| 129 087 000659 | M-T7-243 | MULTİ | 24 V DC | 1 | 66,50 \$ |
| 129 087 000660 | M-T7-223 | MULTİ | 220V AC | 1 | 86,20 \$ |
| 129 087 000661 | MB-T7-243 | MULTİ + BUZZER | 24V DC | 1 | 74,70 \$ |
| 129 087 000662 | MB-T7-223 | MULTİ + BUZZER | 220V AC | 1 | 83,00 \$ |

| Ürün Kodu | Çap (Ø) | Ürün Adı | Çalışma Şekli | Besleme Gerilimi | Adet | Fiyat (\$) |
|-----------|---------|----------|---------------|------------------|------|------------|
|-----------|---------|----------|---------------|------------------|------|------------|

T6 SERİSİ MULTİ FONKSİYON İKAZ LAMBALARI

| | | | | | | |
|----------------|-----|-----------|----------------|---------|---|----------|
| 129 087 000441 | Ø60 | M-T6-24K | MULTİ | 24 V DC | 1 | 33,20 \$ |
| 129 087 000442 | | M-T6-22K | MULTİ | 220V AC | 1 | 47,50 \$ |
| 129 087 000443 | | MB-T6-24K | MULTİ + BUZZER | 24V DC | 1 | 41,50 \$ |
| 129 087 000444 | | MB-T6-22K | MULTİ + BUZZER | 220V AC | 1 | 49,80 \$ |

IŞIKLI KOLONLARDA KIRMIZI SABİT RENKTİR. DİĞER RENKLER SİPARİŞLE YAPILIP, İADESİ YOKTUR.

EKO SERİSİ PROJE ÜRÜNLERİ



EKO SERİSİ KOLİ BAZINDA PROJE ÜRÜNLERİ



CE



| Ürün Kodu | Ürün Adı | Adet | Fiyat (₺) |
|---|----------------------------|------|-----------|
| EKO SERİSİ ABS PANO (BEYAZ KOLİ) | | | |
| 050 901 203013 | EKO 20X30X13 ABS OPAK PANO | 1 | 603,30 |
| 050 901 253515 | EKO 25X35X15 ABS OPAK PANO | 1 | 914,70 |
| 050 901 304017 | EKO 30X40X17 ABS OPAK PANO | 1 | 1.265,00 |
| 050 901 304022 | EKO 30X40X22 ABS OPAK PANO | 1 | 1.366,20 |
| 050 901 355019 | EKO 35X50X19 ABS OPAK PANO | 1 | 1.813,80 |
| 050 901 405018 | EKO 40X50X18 ABS OPAK PANO | 1 | 1.946,20 |
| 050 901 405024 | EKO 40X50X24 ABS OPAK PANO | 1 | 2.206,90 |
| 050 901 406020 | EKO 40X60X20 ABS OPAK PANO | 1 | 2.413,20 |
| 050 901 506022 | EKO 50X60X22 ABS OPAK PANO | 1 | 3.152,80 |
| 050 901 507025 | EKO 50X70X25 ABS OPAK PANO | 1 | 3.678,20 |
| 050 901 608026 | EKO 60x80x26 ABS OPAK PANO | 1 | 5.780,10 |

CE



| Ürün Kodu | Ürün Adı | Koli Adedi | Fiyat (₺) |
|--|--|------------|-----------|
| EKO SERİSİ KLEMENSİZ (KUTUSUZ) OTOMAT KUTUSU - KOLİ BAZINDA | | | |
| 050 931 1X0002 | EKO KLEMENSİZ 2 Lİ S/Ü / S/A SİGORTA KUTUSU | 40 | 89,50 |
| 050 931 1X0004 | EKO KLEMENSİZ 4 LÜ S/Ü / S/A SİGORTA KUTUSU | 27 | 124,60 |
| 050 931 1X0006 | EKO KLEMENSİZ 6 Lİ S/Ü / S/A SİGORTA KUTUSU | 24 | 144,00 |
| 050 931 1X0008 | EKO KLEMENSİZ 8 Lİ S/Ü / S/A SİGORTA KUTUSU | 16 | 198,50 |
| 050 931 1X0012 | EKO KLEMENSİZ 12 Lİ S/Ü / S/A SİGORTA KUTUSU | 18 | 276,40 |
| 050 931 1X0018 | EKO KLEMENSİZ 18 Lİ S/Ü / S/A SİGORTA KUTUSU | 12 | 360,00 |
| 050 931 1X0024 | EKO KLEMENSİZ 24 LÜ S/Ü / S/A SİGORTA KUTUSU | 11 | 459,30 |
| 050 931 1X0036 | EKO KLEMENSİZ 36 Lİ S/Ü / S/A SİGORTA KUTUSU | 8 | 564,40 |

CE



| Ürün Kodu | Ürün Adı | Koli Adedi | Fiyat (₺) |
|--|--|------------|-----------|
| EKO SERİSİ KLEMENSLİ (KUTUSUZ) OTOMAT KUTUSU - KOLİ BAZINDA | | | |
| 050 931 2X0004 | EKO KLEMENSLİ 4 LÜ S/Ü / S/A SİGORTA KUTUSU | 27 | 147,90 |
| 050 931 2X0006 | EKO KLEMENSLİ 6 Lİ S/Ü / S/A SİGORTA KUTUSU | 24 | 167,40 |
| 050 931 2X0008 | EKO KLEMENSLİ 8 Lİ S/Ü / S/A SİGORTA KUTUSU | 16 | 233,50 |
| 050 931 2X0012 | EKO KLEMENSLİ 12 Lİ S/Ü / S/A SİGORTA KUTUSU | 18 | 315,30 |
| 050 931 2X0018 | EKO KLEMENSLİ 18 Lİ S/Ü / S/A SİGORTA KUTUSU | 12 | 428,20 |
| 050 931 2X0024 | EKO KLEMENSLİ 24 LÜ S/Ü / S/A SİGORTA KUTUSU | 11 | 506,00 |
| 050 931 2X0036 | EKO KLEMENSLİ 36 Lİ S/Ü / S/A SİGORTA KUTUSU | 8 | 622,80 |

CE



| Ürün Kodu | Ürün Adı | Koli Adedi | Fiyat (₺) |
|--|---|------------|-----------|
| EKO SERİSİ BUATLAR - KOLİ BAZINDA | | | |
| 050 905 285285 | EKO 85X85X40 KARE ANTİGRON BUAT | 200 | 19,50 |
| 050 905 080040 | EKO 80X40X35 TERMOPLASTİK BUAT | 200 | 15,60 |
| 050 905 085085 | EKO 85X85X50 TERMOPLASTİK BUAT | 160 | 38,90 |
| 050 905 185185 | EKO 85X85X50 TERMOPLASTİK BUAT (VİDALI) | 130 | 44,80 |
| 050 905 080120 | EKO 80X120X55 TERMOPLASTİK BUAT | 85 | 74,00 |
| 050 905 100100 | EKO 100X100X50 TERMOPLASTİK BUAT | 84 | 62,30 |
| 050 905 110110 | EKO 110X110X74 TERMOPLASTİK BUAT | 104 | 66,20 |
| 050 905 120150 | EKO 120X150X80 TERMOPLASTİK BUAT | 30 | 124,60 |
| 050 905 150150 | EKO 150X150X80 TERMOPLASTİK BUAT | 57 | 138,20 |
| 050 905 190150 | EKO 190X150X80 TERMOPLASTİK BUAT | 22 | 157,60 |
| 050 905 200200 | EKO 200X200X80 TERMOPLASTİK BUAT | 32 | 190,70 |
| 050 905 210120 | EKO 210X120X74 TERMOPLASTİK BUAT | 28 | 163,50 |
| 050 905 260150 | EKO 260X150X80 TERMOPLASTİK BUAT | 19 | 210,20 |
| 050 905 280210 | EKO 280X210X74 TERMOPLASTİK BUAT | 17 | 272,50 |
| 050 905 380280 | EKO 380X280X90 TERMOPLASTİK BUAT | 10 | 420,40 |

* Koli bazında proje ürünleri yıl sonu prim sistemine dahil değildir.

* X yerine siva üstü için 0, siva altı için 1 rakamını yazınız.

SPİRALLİ KABLolar

SPİRALLİ ENERJİ KABLoları HALOJEN FREE



| Ürün Kodu | Kablo Kesit (mm ²) | Spiral Özellik | Spiral Çap (Ø mm) |
|--|--------------------------------|----------------|-------------------|
| H07Z1-U (NYA) KABLolar HALOJEN FREE | | | |
| 122 051 215014 | 2 x 1,5 | HF-PE | 16 |
| 122 051 315014 | 3 x 1,5 | HF-PE | 16 |
| 122 051 415016 | 4 x 1,5 | HF-PE | 16 |
| 122 051 515020 | 5 x 1,5 | HF-PE | 20 |
| 122 051 225014 | 2 x 2,5 | HF-PE | 16 |
| 122 051 325016 | 3 x 2,5 | HF-PE | 16 |
| 122 051 425020 | 4 x 2,5 | HF-PE | 16 |
| 122 051 525025 | 5 x 2,5 | HF-PE | 25 |

SPİRALLİ ZAYIF AKIM KABLoları HALOJEN FREE



| Ürün Kodu | Kablo Kesit (mm ²) | Spiral Özellik | Spiral Çap (Ø mm) |
|---|---|----------------|-------------------|
| (LSZH) DATA KABLoları HALOJEN FREE | | | |
| 122 053 100516 | U/UTP CAT5e (4x2x24AWG) | HF-PE | 16 |
| 122 053 100616 | U/UTP CAT6 (4x2x23AWG) | HF-PE | 16 |
| (PHY - HF) KOAKSİYEL KABLoları HALOJEN FREE | | | |
| 122 053 200416 | RG 6 U/4 (Cu/AL) | HF-PE | 16 |
| 122 053 200616 | RG 6 U/6 (Cu/Cu) | HF-PE | 16 |
| CCTV KAMERA KABLoları HALOJEN FREE | | | |
| 122 053 301214 | 1+2 RG 59 Mini (2x0,50 mm ²) | HF-PE | 16 |
| 122 053 301416 | 1+4 RG 59 Mini (2x0,50 mm ² + 2x0,22 mm ²) | HF-PE | 16 |
| J-H (st) H YANGIN İHBAR KABLoları HALOJEN FREE | | | |
| 122 053 401214 | 1x2x0,80 mm ² + 0,80 mm ² | HF-PE | 16 |
| 122 053 402216 | 2x2x0,80 mm ² + 0,80 mm ² | HF-PE | 16 |
| LIHH DİYAFON KABLoları HALOJEN FREE | | | |
| 122 053 502216 | LIHH 8x0,22 mm ² | HF-PE | 16 |

Tüm spirallerin HALOJEN FREE özelliği mevcuttur.

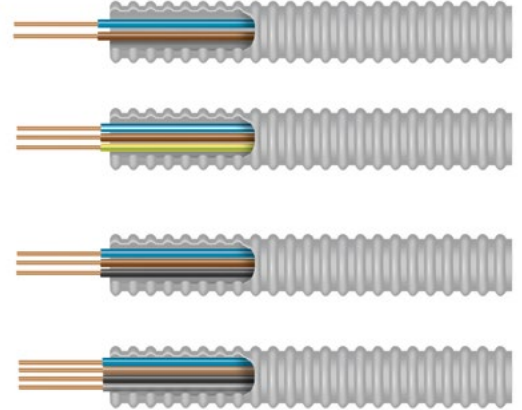

SPİRALLİ ENERJİ KABLoları

| Ürün Kodu | Kablo Kesit (mm ²) | Spiral Özellik | Spiral Çap (Ø mm) |
|-------------------------------|--------------------------------|----------------|-------------------|
| H07Z1-U (NYA) KABLolar | | | |
| 122 050 215014 | 2 x 1,5 | HF-PE | 16 |
| 122 050 315014 | 3 x 1,5 | HF-PE | 16 |
| 122 050 415016 | 4 x 1,5 | HF-PE | 16 |
| 122 050 515020 | 5 x 1,5 | HF-PE | 20 |
| 122 050 225014 | 2 x 2,5 | HF-PE | 16 |
| 122 050 325016 | 3 x 2,5 | HF-PE | 16 |
| 122 050 425020 | 4 x 2,5 | HF-PE | 16 |
| 122 050 525025 | 5 x 2,5 | HF-PE | 25 |

SPİRALLİ ZAYIF AKIM KABLoları

| Ürün Kodu | Kablo Kesit (mm ²) | Spiral Özellik | Spiral Çap (Ø mm) |
|--|---|----------------|-------------------|
| DATA KABLolar | | | |
| 122 052 100516 | U/UTP CAT5e | HF-PE | 16 |
| 122 052 100616 | U/UTP CAT6e | HF-PE | 16 |
| KOAKSİYEL KABLolar | | | |
| 122 052 200416 | RG 59 U/2 (Cu/AL) | HF-PE | 16 |
| 122 052 200616 | RG 6 U/4 (Cu/AL) | HF-PE | 16 |
| 122 052 200616 | RG 6 U/6 (Cu/Cu) | HF-PE | 16 |
| CCTV KAMERA KABLoları | | | |
| 122 052 301214 | CCTV 1+2 (2x0,22 mm ²) | HF-PE | 16 |
| 122 052 301416 | CCTV 1+4 (2x2x0,22 mm ²) | HF-PE | 16 |
| J-H (st) H YANGIN İHBAR KABLoları | | | |
| 122 052 401215 | JY(st)Y 1x2x0,80 mm ² + 0,40 mm ² | HF-PE | 16 |
| 122 052 402216 | JY(st)Y 2x2x0,80 mm ² + 0,40 mm ² | HF-PE | 16 |
| LIHH DİYAFON KABLoları | | | |
| 122 052 502216 | DT-8 8x0,22 mm ² | HF-PE | 16 |

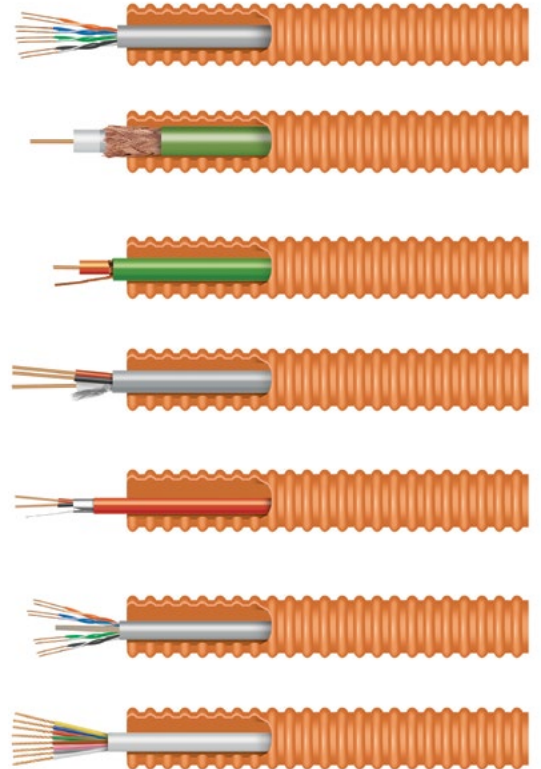

* Güncel fiyatlar için satış temsilciniz ile irtibata geçiniz.

**DAYANIKLI
GÜVENLİ
KOLAY
KULLANIM**

ŞALT GRUBU

Önceliğiniz
MUTLUSAN'ın
A.G. Çözümleri
OLACAK...



Detaylı Bilgi İçin





Mutlusan Plastik Elektrik San ve Tic. A.Ş.

İkitelli Org.San. Bölgesi Mahallesi Enkoop Cad.
No:7 Başakşehir- İstanbul
Tel : +90 (212) 485 05 44 (PBX)
Faks : +90 (212) 485 10 12

Karaköy Şube

Okçumusa Cad. Güneşhan İş Hanı No : 24/10
Karaköy-İstanbul
Tel : +90 (212) 237 06 02 (PBX)
Fax: +90 (212) 237 77 47

Perpa Şube

Perpa Tic. Merkezi. A Blok Kat: 2
No: 9-009 Okmeydanı - İstanbul
Tel : +90 (212) 320 05 78 (PBX)
Fax: +90 (212) 320 05 81